

# LIGHTBURN

BETTER SOFTWARE FOR LASER CUTTERS

*LightBurn Software*

*(C) LightBurn Software, LLC*

# Table of Contents

---

1. Home	4
2. Disclaimer and Safety	5
3. Beginner Docs	6
3.1 What Is LightBurn?	6
3.2 Beginner Walkthrough	7
3.3 Downloading & Installing LightBurn	18
3.4 LightBurn UI Tour	20
3.5 Zooming, panning, and selection	24
3.6 Feature Comparison	26
4. Primary Docs	28
4.1 Tips and Tricks	28
4.2 Installation & Licensing	30
4.3 Adding A Laser	32
4.4 Configuring A Laser	41
4.5 User Interface & Features	48
4.6 Advanced Topics	137
4.7 Troubleshooting	157
4.8 Machine Guides	164
5. Galvo Docs	178
5.1 LightBurn & Galvos	178
5.2 Glossary (Galvo)	180
5.3 Installing Drivers (Windows only)	182
5.4 Adding & Setting Up Your Galvo	185
5.5 Configuring Galvo Settings	189
5.6 Lens Correction	194
5.7 Framing	195
5.8 Lens Focusing & Calibration Tools	200
5.9 Cylinder Correction Marking	202
5.10 LightBurn Fill & EZCAD Hatch Quick Translation	207
5.11 Rotary Setup (Galvo)	209
5.12 Changing A Lens	216
5.13 3D Sliced Engravings	218
5.14 About Galvos	220
6. Tags	223
6.1 Advanced	223

6.2 Beginner Docs	223
6.3 Calibration	223
6.4 DSP	223
6.5 Editing	223
6.6 First Steps	223
6.7 GRBL	224
6.8 Galvo	224
6.9 Gantry	224
6.10 Guides	224
6.11 Libraries	224
6.12 LightBurn 1.2	224
6.13 LightBurn Bridge	225
6.14 Machine Guides	225
6.15 Primary Docs	225
6.16 Rotary	226
6.17 Ruida	226
6.18 Sculpfun S9	226
6.19 Settings	226
6.20 Text & Fonts	226
6.21 Thunder Laser	226
6.22 Tools	226
6.23 Trocen	227
6.24 Troubleshooting	227
6.25 UI	227
6.26 Windows	227

# 1. Home

---

# LIGHTBURN

BETTER SOFTWARE FOR LASER CUTTERS

---

Welcome to the LightBurn Docs!

Please use the search bar at the top of the page or click the closest match for what you're trying to find.

[Disclaimer and Safety](#)

Beginner Pathway

---

- [Installing LightBurn](#)
- [Adding your laser to LightBurn](#)
- [Configuring a laser for use with LightBurn](#)
- [How To Use LightBurn](#)
- [Zooming, Panning, and Selection](#)
- [Getting started - Making a simple project](#)
- [Coordinates, Device Origin, and Job Origin - Placing your work](#)

Primary Documentation

---

- [How to use specific features in LightBurn](#)
- [Cool tricks and usability tips](#)
- [Working with Other Software](#)
- [LightBurn Bridge Docs](#)
- [Using A Rotary](#)
- [Galvo Docs](#)

[Download PDF Version](#)

## 2. Disclaimer and Safety

---

### Danger

Lasers use intense beams of light to create heat and fire as a normal part of their operation, and depending on the laser, the light might not be visible to you. When used safely, a laser cutter is an incredibly useful tool. However if the proper safety measures are ignored, you could burn or blind yourself or someone else, or start a fire that could damage or destroy your home, or in the worst case, kill someone. CO<sub>2</sub> lasers use high voltages, and if wired incorrectly could kill you.

***Do not leave a running laser unattended.***

By using this software, the user accepts complete responsibility for each and every aspect of safety associated with the use of the laser machine, laser system and LightBurn Software.

#### ***You agree that:***

1. You will not hold the author or contributors of LightBurn liable for any damage to equipment or persons from the use of LightBurn.
2. You understand the potential hazards in using high power lasers and high voltages.
3. You will wear proper eye protection rated for your laser when operating it.
4. You will use the LightBurn software in a legal and safe manner.
5. You relieve the author and contributors from any liability arising from the use or distribution of the LightBurn software.
6. You are entirely operating at your own risk. Lasers can be lethally dangerous.

## 3. Beginner Docs

### Beginner Docs First Steps

### 3.1 What Is LightBurn?

LightBurn is layout, editing, and control software for your laser cutter. LightBurn talks directly to your laser, without the use of additional software.

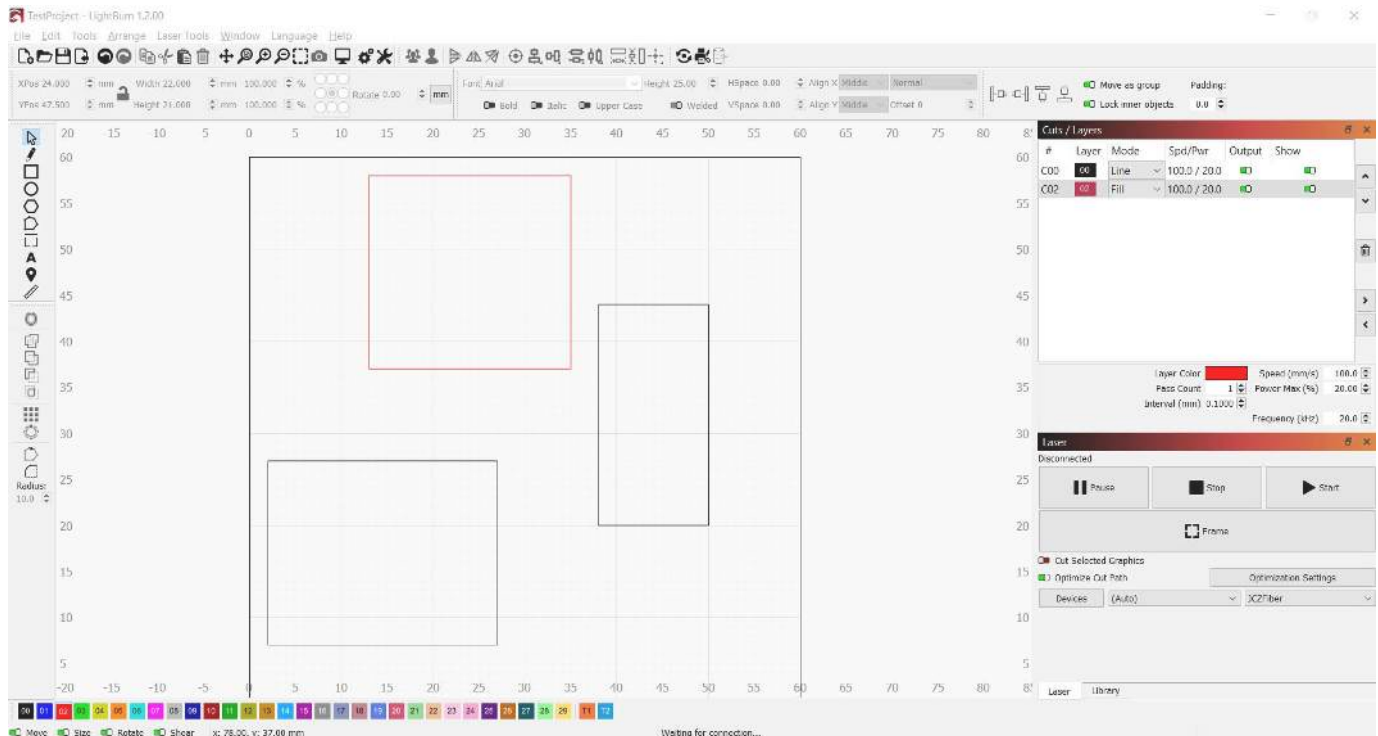

With LightBurn you can:

- Import artwork in a variety of common vector graphic and image formats (including AI, PDF, SVG, DXF, PLT, PNG, JPG, GIF, BMP)
- Arrange, edit, and even create new vector shapes within the editor, with powerful features like offsetting, boolean operations, welding, and node editing
- Apply settings like power, speed, number of passes, cut order, brightness & contrast, dithering mode, and much more
- Send the result directly to your laser cutter

LightBurn is a native application written for Windows, macOS, and Linux.

## 3.2 Beginner Walkthrough

### Beginner Docs First Steps

#### 3.2.1 Adding & Configuring for Beginners

LightBurn can't control every laser, but it can talk to a number of different types of laser controllers, all of which use different ways of communicating, and have different abilities and settings.

This step tells LightBurn what you have.

If you've never configured a device in LightBurn, you'll be brought here automatically when you run the software. It is important that you pick *something* because the interface in LightBurn will change depending on the capabilities of the laser you choose. If you don't have a laser to connect to yet, you can [create a placeholder device](#)

If you've done this before, but want to change your laser, or add a new one, click the 'Devices' button in the [Laser Window](#) to bring up the devices list.

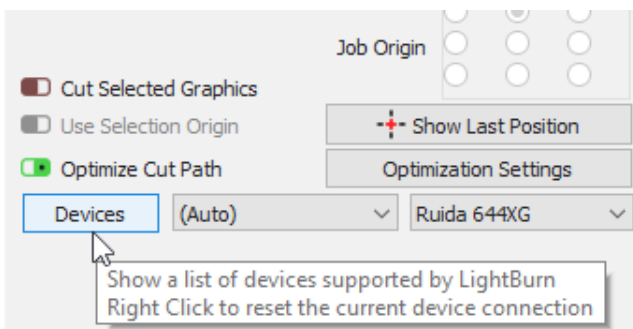

LightBurn can also be configured to control more than one laser, and there are settings stored for each device. If you don't pick one, we have nowhere to put these settings, and a number of features within LightBurn will not work until this is set up.

#### The Devices page

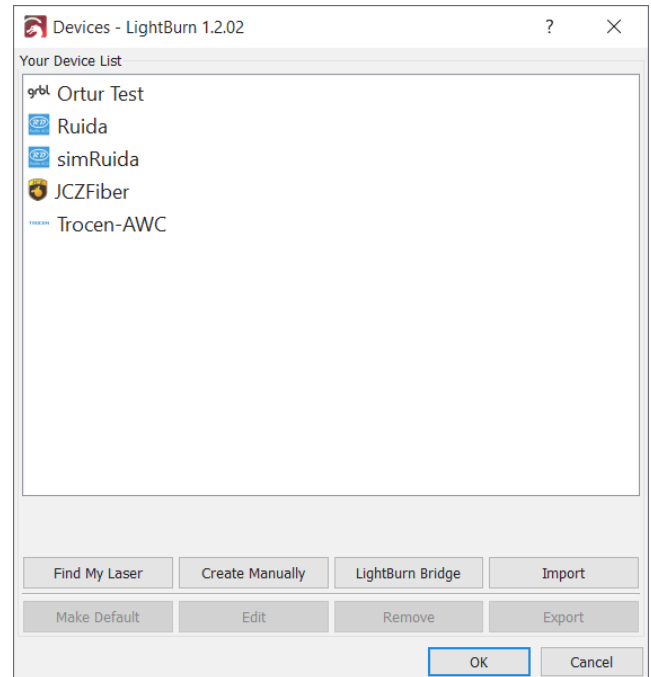

This is the Devices page in LightBurn. Here you will see a list of all the laser devices you've added to LightBurn, or an empty list when you're first starting.

The simplest way to proceed is to click '[Find My Laser](#)' and let LightBurn try to figure out what you have. If that doesn't work, your laser connects with Ethernet, or you have a Marlin device, you'll need to use '[Create Manually](#)'. If you're using a LightBurn Bridge device, you can use the [LightBurn Bridge](#) setup.

- [Find My Laser](#)
- [Create Manually](#)
- [LightBurn Bridge](#)

You can also import and export laser configurations to move them between computers using the [Export](#) button on this page from the source computer, and then import it to the new install using the [Import](#) button. Exporting will create a `.lbdev` (LightBurn device) file, which contains all of the device specific information LightBurn needs to make that machine's profile on the new computer.



You can import a LightBurn Device profile by dragging and dropping it into your [main window](#).

### What if I don't have a laser yet?

You don't ever need to connect a laser to LightBurn to use it, but LightBurn will not run without a device profile configured, because it needs a place to store some settings, and wants to know what options to show you in the interface. If you use a laser that accepts files on a USB drive, for example, LightBurn needs to know which controller it uses so it can produce the correct output files.

To start using LightBurn without a laser, use [Create Manually](#) and configure the things you can, and guess at whatever you don't know. When you finally do get your laser, you can come back to this screen, select the 'dummy' profile you set up, and click 'Remove'. Then you can follow the set-up steps here for real this time and use your laser!

### Configuring

If you have a GCode controller, particularly if you also use your system as a CNC or 3D printer, there may be additional configuration required.

- [Common GRBL setups](#)

If you have a Ruida DSP controller, and are configuring from scratch, read here:

- [Configuring a Ruida](#)

If you're using a galvo laser, start here.

- [Configuring A Galvo](#)



### 3.2.2 Coordinates and Job Origin

There are a few ways to tell LightBurn how to place the project within the work area of your machine. You choose them in the "Start From" box on the Laser tab:

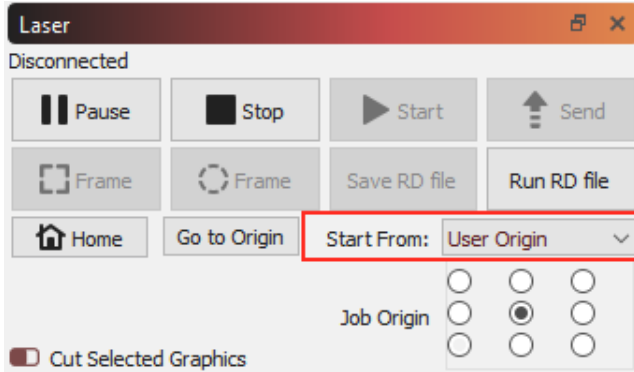

#### Absolute Coordinates

**Absolute Coordinates** is the simplest - The page grid you see in the main editing window represents your machine's work area. Anything you place in that area will be cut in the corresponding place on your machine. Users with small lasers like the K40 will likely find this the simplest and most intuitive option.

**Note:** Using absolute positioning requires a laser with homing switches and a fixed origin. If you have a small diode laser that does not have homing sensors, you will need to manually zero the machine. See [Machines without homing sensors / limit switches](#).

In the image below, the two circles placed in the middle of the work area will be cut in the middle of the machine work area. The green square in the lower-left of the image represents the Job Origin, and the red square in the same place shows the Machine Origin. In "Absolute Coordinates" these are always in the same place.

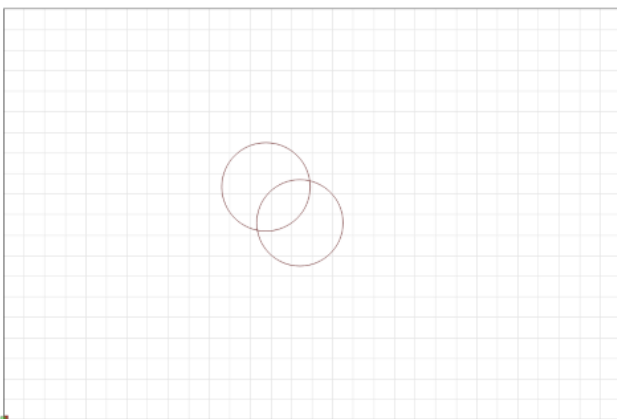

#### Current Position

**Current Position** is probably the next easiest to use. Your job cuts relative to the current position of the laser head when you hit the Start button. You use the "Job Origin"

control in the Laser window to tell LightBurn how to position the job relative to the laser.

In this image, we're starting from the Current Position, with the Job Origin set to the lower left:

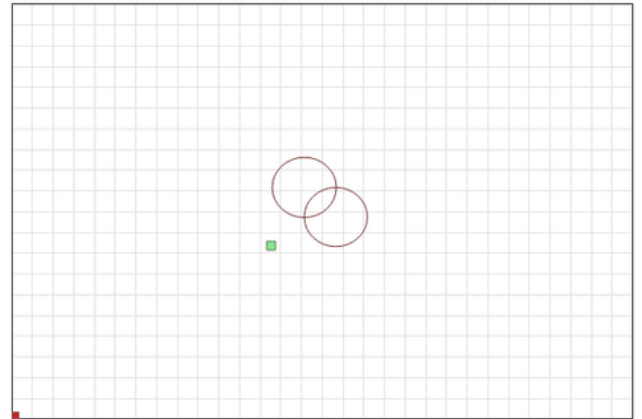

Notice that the green "Job Origin" indicator has moved. This represents the position of the laser when you start the job, so the laser is going to move slightly up and to the right from wherever it is, cut the two circles, and go back to where it started.

Imagine that you wanted to cut this amazing two-circle pattern onto a beverage coaster or a phone case. Lining it up like this is not easy. If you change the Job Origin setting to "Center", you get this instead:

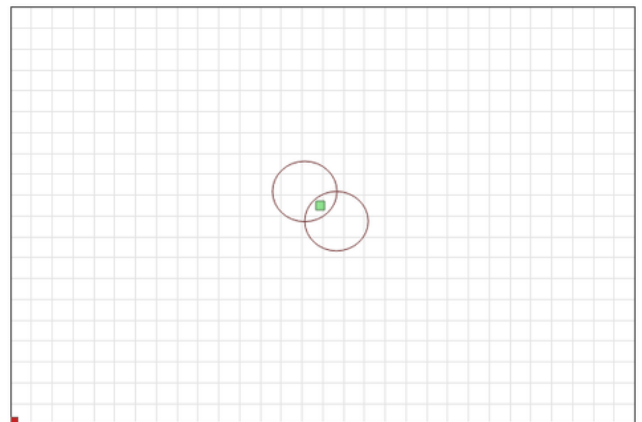

Now the job is going to be cut centered around the current position of the laser head. If you position the laser directly over the center of the item you want to cut, the resulting image will be centered on the item.

Using Current Position and Job Origin together lets you line up a cut on a piece of material with ease, once you understand how it works.

#### User Origin

**User Origin** works almost exactly the same as Current Position, except that the starting location is "programmable". Some lasers have an "Origin" button on them (like Ruida controllers). GCode based systems use the "Set Origin" button in LightBurn to do the same thing. You jog your laser to the position you want your job to start from,

hit the "Set Origin" button, and then you're free to move the laser around again. If you specify "User Origin" as the "Start From" value, the laser will move back to that programmed location and start the cut from there.

### Finish Position

*Note that the Finish Position setting is only for GCode-based controllers. DSP controllers manage this internally.*

LightBurn gives you the control of where you want the head of the laser to return to after a job is finished. By default it will return to 0,0 however this is not the optimal location for some machines.

To change your finish position, go to the **Move tool window** and use the arrows to reposition your laser head to where you would like it to return to on job finish. Then click the **Set Finish Position** button. Your machine will now remember that spot for future jobs. This can be reset at any time by repeating these steps for a new location.

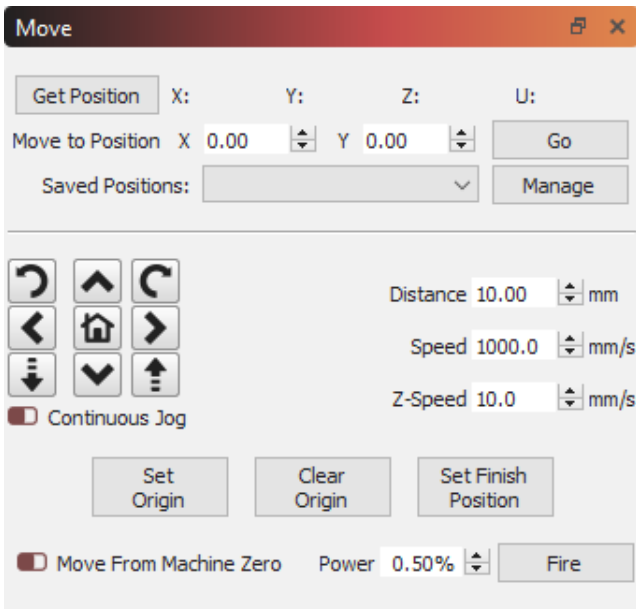

### 3.2.3 Basic Usage: The Essentials

So far we've done a [brief introduction to the UI](#) and covered [zooming, panning, and selecting](#).

The next things we'll cover are:

- [Creating Shapes](#)
- [Importing Artwork](#)
- [Moving and Sizing Artwork](#)
- [Grouping](#)
- [Cut Layer Settings](#)
- [Controlling the Laser](#)

#### Creating Shapes

LightBurn's [shape creation tools](#) let you create simple shapes. Choose a tool from the left toolbar, like the ellipse, rectangle, or polygon tools. With a tool selected, left-click in the workspace and drag the mouse to adjust the size of the shape you're creating. While dragging, the Shift key will force the shape to have the same width and height, so you get circles and squares instead of ellipses and rectangles. The Ctrl key causes the shape to be centered on the starting point, instead of dragging it out from corner to corner. Release the mouse button to finalize the shape.

For text, select the text tool, then click in the edit window to place the cursor. Type your text, and press the Esc key when finished.

#### Importing Artwork

The [shape creation tools](#) let you make simple shapes in LightBurn, like circles, rectangles, text, and polygons, and also give you the ability to edit and adjust them, but LightBurn isn't intended to be a complete artist package or dimensioned modeling tool. For that, you would use external software like CorelDraw, Adobe Illustrator, Inkscape, or AutoCAD. Photo or image manipulation software such as Photoshop or GIMP can be used to create or manipulate image files.

When you have artwork ready in one of these programs, the next step is to import it into LightBurn to adjust the settings. LightBurn can import the following file types:

##### Vector / mixed formats:

- .ai - Adobe Illustrator
- .svg - Scalable Vector Graphics
- .dxf - AutoCAD Drawing Exchange Format
- .pdf - Adobe Portable Document Format
- .plt / .hpgl - Plotter / Hewlett-Packard Graphics Language

##### Image formats:

- .png - Portable Network Graphics
- .jpg / .jpeg - Joint Photographic Experts Group format
- .bmp - Windows Bitmap
- .gif - Graphics Interchange Format

- .tif / .tiff - Tagged Image File Format

Note that not all features of every format will be supported. Vector graphics formats in particular are incredibly complex, and using more advanced features, like pattern fills, masking, gradients, and so on will not necessarily translate well when importing. LightBurn cares about shape outlines - if you want artwork to include the advanced features, the best option is usually exporting as a high-DPI image.

You can import files into LightBurn in several different ways:

-  Clicking the Import button on the main toolbar
- Using the File > Import option from the main menu
- Pressing the Import keyboard shortcut (Ctrl + I)
- Dragging a file from the Windows Explorer or MacOS Finder into LightBurn
- Copying and Pasting an image from a browser window into LightBurn

#### Moving and Sizing Artwork

Once you have your artwork in LightBurn, the next step is usually placing or sizing it. When one or more items are selected, you'll see various "tool handles" appear around the outside of the selection, like this:

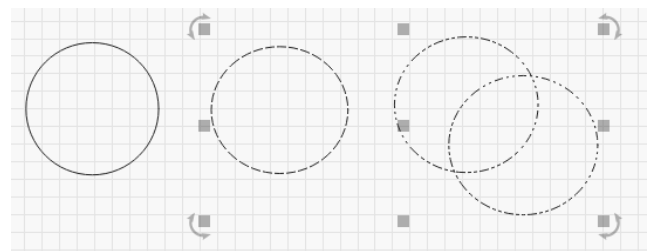

In the image above, you can see 9 gray squares, and four arrows. If you hover your mouse over any of them, the cursor will change to indicate the kind of operation that tool performs - resizing, moving, or rotating.

Grabbing any of the four corners will let you resize the artwork from that corner, and defaults to uniform resizing with the opposite corner as the anchor point. Holding the Ctrl key (or Command on Mac) switches the anchor point to the center, so the object center remains in place when resizing. Holding the Shift key allows you to resize the width and height independently, instead of locking them together.

Grabbing any of the four side handles will let you adjust the width or height of the selection, and the Ctrl (or Command) key switches to center anchor just as it does with corner sizing. When moving, the status bar shows both the absolute position of the selection being moved, and the relative distance it has moved.

The center handle is for moving the selection, though you can also click and drag any edge of any shape to do this as well. When moving a selection, holding the Shift key constrains the movement to be horizontal, vertical, or diagonal.

The four rotate handles allow you to rotate the object freely using the mouse. While rotating, the relative rotation is

displayed in the status bar. Holding the Ctrl key (Command on Mac) snaps the rotation to the nearest 5 degrees, holding Shift will snap to 15 degrees, and holding Ctrl+Shift snaps to 45 degrees.

You can also move, rotate, and resize artwork using the [Numeric Edits Toolbar](#).

## Grouping

When you create shapes in LightBurn, they're independent of other shapes you create. Sometimes it's handy to be able to treat a collection of things as a single unit, to make sure they keep their relative position and size when you're moving them around. In LightBurn, this is called a Group. If you select two or more shapes and click the 'Group' button



() , or press  $\text{^} \text{Ctrl} + \text{G}$ , you'll create a new object that contains the original shapes. To un-group the objects so you can edit the individual parts, select a group of shapes



and click the un-group button () , or  $\text{^} \text{Ctrl} + \text{U}$ .

You can tell if a shape is in a group or not based on how it looks when selected.



Ungrouped objects are displayed with a simple dash pattern when selected, like the single circle above on the left. A grouped shape shows a repeating dot-dot-dash pattern when selected, shown on the three smaller circles above on the right.

## Cut Layer Settings

Artwork imported from vector files assigns shapes to layers in LightBurn based on the colors of the vectors in the original file. If you create your files with this in mind, it can save you time.

Layers in LightBurn are used to assign different settings to the shapes in your design. For example:



In the above design, black could be used for a solid, dark engraving, blue could be a very light engraving with an outline to add definition to the text, and red would be a slow,

high-power cutting layer. The final output to the laser might look like this:

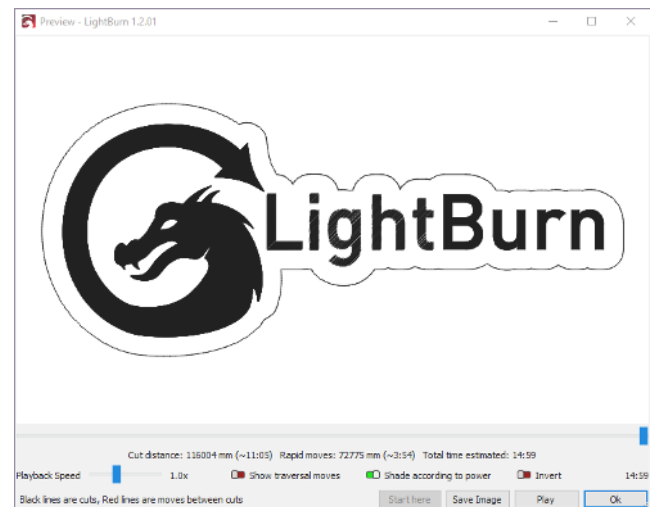

The information shown in the Cuts / Layers window is just the basics. You can see the full set of options for a layer by double-clicking the entry in the layer list to bring up the [Cut Settings window](#).

## Controlling the Laser

There are two windows primarily used to control the laser:

The [Laser Window](#), shown in the lower right of the display by default, lets you select your laser, start, stop, or pause a job, frame the design (move the laser head around the boundary of your design to test alignment), and more. These options can vary based on the type of laser you're using.

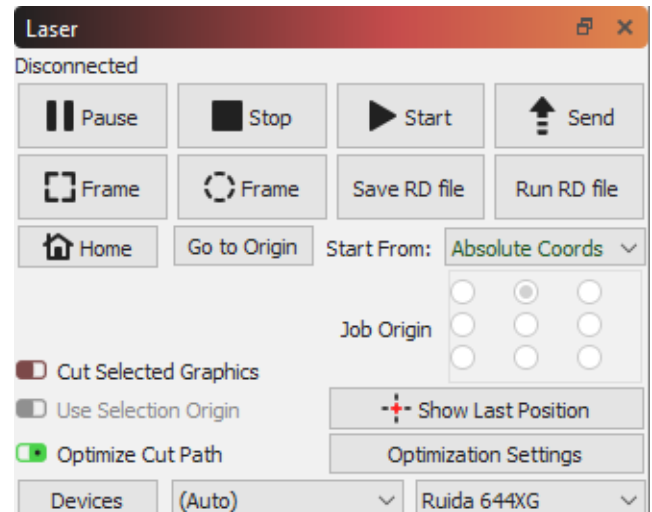

The [Move Window](#), docked behind the Cuts / Layers window by default, gives you jog buttons and positioning control, and the 'Speed' value there is used when framing or jogging the laser in LightBurn.

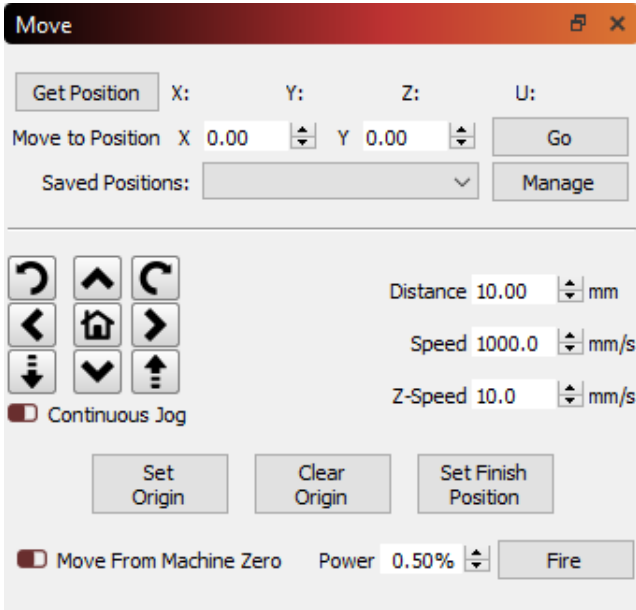

There are a couple other methods for moving the laser that are noteworthy:

- The Click-to-Position tool (  ) on the Creation Tools toolbar lets you click anywhere in the workspace and LightBurn will jog the laser to that point.
- Note that this assumes that your laser has been properly homed - Some DIY-style machines do not have homing

- switches, so using any form of absolute positioning in LightBurn requires extra steps.
- The number pad arrow keys can be used to jog the laser after clicking in the edit window (workspace).
- The Arrange menu and arrangement tools can be used to move the laser relative to artwork in the workspace.

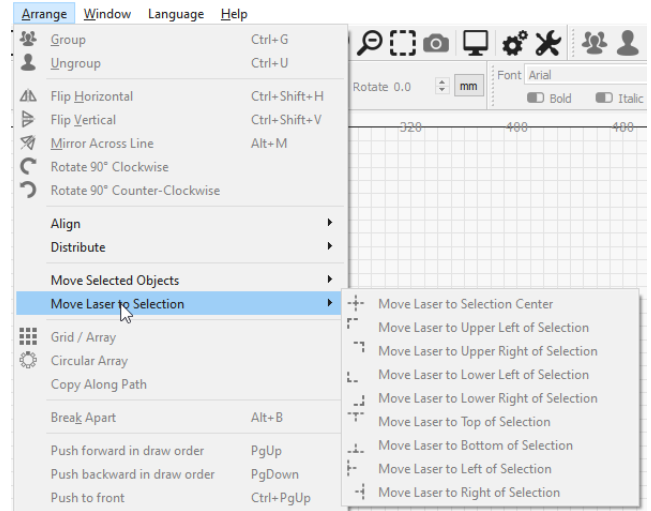

## Beginner Docs First Steps

### 3.2.4 Making a Simple Project

We're going to go step-by-step through creating a small, simple project in LightBurn, from start to finish, to show you how to use a few of the basic editing tools, and give you a feel for how things work.

Before you start, make sure you have a laser set up in LightBurn (see [Adding your Laser](#)).

This project will be a simple name tag, cut out around the letters, ideally made from thin wood or acrylic, but a piece of cardboard will do.

#### CREATING THE TEXT

With LightBurn running, and an empty project, click the Create Text button shown below. It normally lives along the left side of the main window:



Next, click the mouse somewhere in the middle of the Edit window (the workspace) to get a cursor, then type your name:



Click the 'Select' tool button on the top left of the edit window, or press **Esc** twice (once to finish entering text, and again to exit text entry and go back to selection mode).

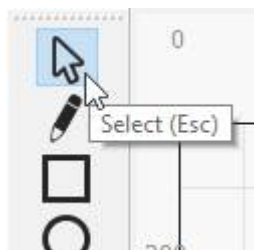

When you finish the text, you'll see an entry appear in the **Cuts / Layers** list on the upper right of the display. This is the "layer" that your text is on, and it holds the settings that will be sent to the laser for all the objects on this layer:

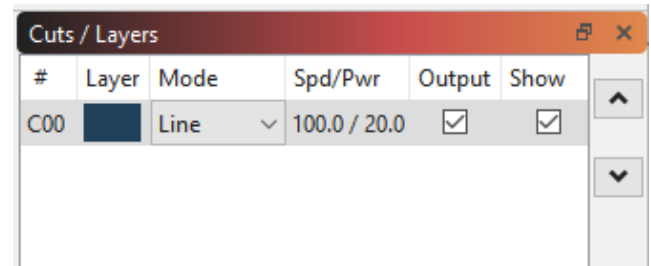

This tells us that the shapes on this layer will be drawn as lines, with 100 mm/sec speed, and 20% power. Depending on your settings, the '100.0' might be different - Diode lasers are less powerful than CO2 lasers, and run slower, so they tend to use mm/minute as units, so the same default value would display as 6000 mm/min. If you have your units set to Inches, you might see 3.9 in/sec, or 236 in/min.

#### PREVIEWING

To see how the laser will run your project, click the **Preview** button in the middle of the main toolbar:



The preview window will pop up, showing the completed job, like this:

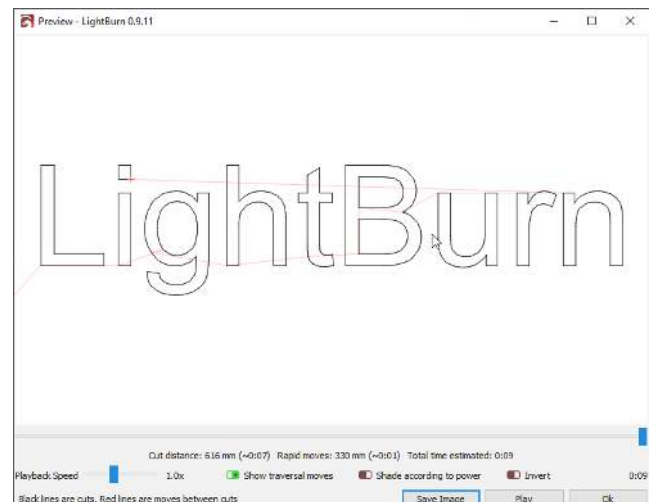

The lighter red lines are showing the laser moving between the shapes (traversal moves), and the black lines are where the laser will burn. Click the 'Play' button and you can watch a simulation of how the laser will run the job. You can also grab the slider and drag it around to see the cut at different points in time. Spot checking the output like this is a good habit to get into, because you'll likely spot mistakes before you burn the project for real, saving time and material. Click the 'Ok' button to close the preview.

For more information on the preview window see its page [here](#) **Preview Window**

**CHANGING TEXT PROPERTIES**

Make sure you're still in Selection mode - the 'Select' tool should be highlighted. Click the name, or click and drag a rectangle around it to select it. When it's selected, it will be drawn as animated dashes instead of solid lines, and handles will appear around the selection to let you change the size, position, or orientation.

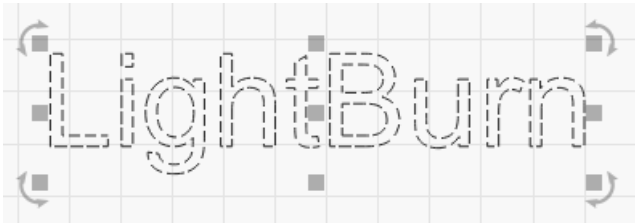

The options in the Text Toolbar at the top will activate, like this:

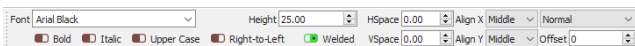

Click the drop down for the font, and change it to anything you like. While you are choosing, the changes will be displayed in real time in the edit window. You can change the height, make it bold or italic, and adjust spacing here too.

**UNDO / REDO**

If you make a change you don't like, you can undo it by clicking the Undo button on the toolbar (or pressing **^ Ctrl1** + **Z**), or Edit > Undo in the menu). If you decide you liked it after all, you can also Redo (**^ Ctrl1** + **Shift** + **Z**) / **⌘ Cmd** + **Shift** + **Z**). Undo and Redo in LightBurn are unlimited - the undo system doesn't reset unless you create a new file or close the program.

**CHANGING THE LAYER SETTINGS**

Rather than outline the text, we're going to change it to be solid filled. In the Cuts / Layers window, click where it says 'Line' and change it to 'Fill', like this:

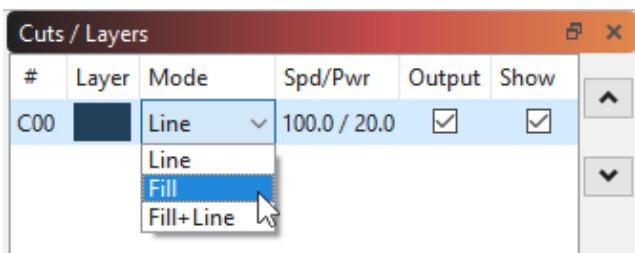

You'll notice that the display in the edit window hasn't changed, but if you run the preview again, it looks quite different. By default, the view in LightBurn shows outlines only, not fills, because it's much faster, and it prevents things from being hidden behind solid shapes that might still be run on the laser.

**ADDING AN OUTLINE: THE OFFSET TOOL**

With the text selected, click the 'Offset' button on the left toolbar, shown here:

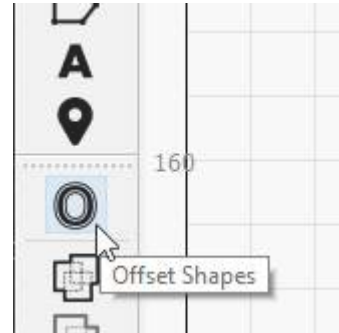

The Offset options window will appear, and you should see something like this:



The offset tool creates a new shape by outlining the shapes in your selection at a given distance, either inward, outward, or both, and merging the result. If you point the mouse at the 'Offset Distance' value, you can scroll the mouse wheel to change the number and watch the result change on the fly. You can also click the box and just enter a number as well.

Make the Offset Distance value large enough that there are no internal gaps in the outline - Notice the gap above between the L and the next letter is gone in the version below:

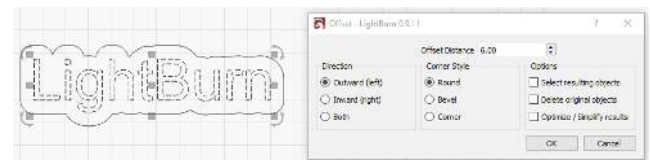

When you're happy with the result, click 'OK'.

**CHANGING LAYERS**

Now, use the left mouse button to click the new outline you just made, so it is the only thing selected, like this:



Then, click the Red button in the color palette at the bottom of the display:

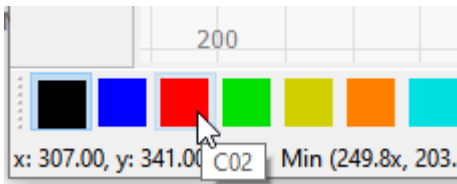

The outline will turn red, and you should see two entries in your Cuts / Layers list, like this:

#	Layer	Mode	Spd/Pwr	Output	Show
C00	Black	Fill	100.0 / 20.0	<input checked="" type="checkbox"/>	<input checked="" type="checkbox"/>
C02	Red	Line	100.0 / 20.0	<input checked="" type="checkbox"/>	<input checked="" type="checkbox"/>

The first, the black layer, is the fill for your text, and the second red layer is for the outline cut.

#### SPEED AND POWER

This is where things get a little tricky in terms of you being able to follow along. Speed and power settings vary quite a bit between lasers, and LightBurn supports a lot of different types of machines. It also depends on the kind of material you're using - cutting through 1/8" basswood uses much less power than cutting through 1/4" plywood or acrylic. For right now we'll assume 1/8" (3mm) plywood and give some guesses for settings, but you'll probably have to change them.

To start with, click the black color entry in the Cuts / Layers window. Below the list of layers you'll see the Cut Info window, containing something like this:

Cut Info			
Layer Color	Black	Speed (mm/s)	100.0
Pass Count	1	Power Max (%)	20.00
Interval (mm)	0.100	Power Min (%)	10.00
		Material (mm)	0.0

For the text, you want enough power to engrave into the material you're using, but not too deep.

- If you have a CO<sub>2</sub> laser, use 200 mm/sec, 15% power (both Power Min and Power Max - more on this later) and leave everything else.
- If you have a diode laser, use 50 mm/sec (or 3000 mm/min), and 50% power.

Understand that this is a rough starting point, and you will probably need to change this later.

Now, click the red entry in the Cuts / Layers window. This is going to be what cuts through the material to cut out the shape. Cutting requires more power and much less speed.

- For a CO<sub>2</sub> laser, set 15 mm/sec, 75% power (again for both min and max power)
- For a diode laser, use 2 mm/sec (120 mm/min), and 100% power. Depending on the strength of the diode you have,

you might need to go slower than this, or use more passes by setting the Pass Count value higher.

Again, these are guesses, but they're a starting point.

Open the Preview window again (Alt+P, or click the Preview button), then drag the progress slider from left to right to watch how the job will run. You'll see the text engrave first, followed by the outline cut. If you don't see those things, check the settings again, and verify that you have the first layer (black) set to Fill, and the second layer (red) set to Line.

#### POSITIONING THE JOB ON THE LASER

When sending this to the laser, there are a couple of different ways that it can be positioned, and the one you choose may depend on the kind of hardware you have. If you have a small diode laser that does not have homing switches, you will likely want to run the job using the 'Current Position' mode. For now, that's what we'll recommend for everyone, since it's easy.

If you have an Ortur Laser Master, or other small laser that does have homing switches enabled, you will likely find 'Absolute Coords' to be the simpler setting to use - this means that wherever you place your work in LightBurn is exactly where it will go on the laser.

In the Laser window, which is in the lower-right of the main window by default, look for the 'Start From' drop down box, and choose 'Current Position' or 'Absolute Coords'. If you see 'Controller Setting' in this window, it means you have a Trocen Controller, and the start position is set from the controller menus, not from software. Don't sweat it for now.

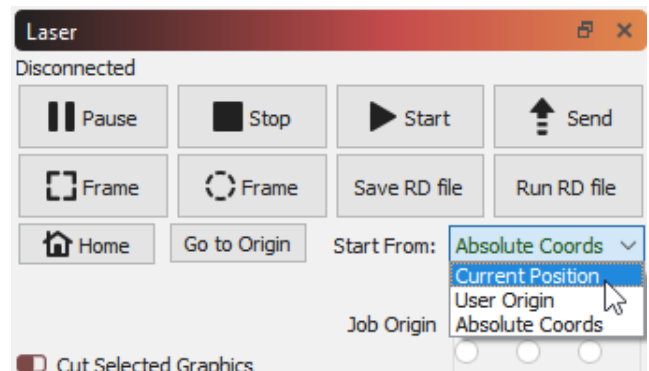

If you used 'Current Position' mode, you'll see the 9-dot "Job Origin" control under it activate, and you should see a green square on your design in the same spot indicated by Job Origin control, like this:



In the above image, the Job Origin is set to the lower-left, and that's where the green origin square is on the design. That green square represents the position of the laser before you start the job, so the design is going to end up above and to the right of wherever the laser is when we press Start.



Put a piece of material in the bed of the laser, and use the arrow keys on the laser controller (if you have that) to move the head of the laser to the lower-left corner of the material. If your laser controller doesn't have arrows, click an empty spot in the edit window, then use the arrows on the Number Pad of your keyboard to jog the laser around instead.

When you think it's lined up, press the button labeled 'Frame'. The head of the laser will move in a rectangle around where the job will go. If you need to adjust anything, do so, then Frame again.

If you only have the option for 'Controller Setting' in the above window, when you position the laser in the lower corner of the material, press the button labeled 'Origin' on the controller panel to tell the controller this is where you'd like the job to start.

When everything is lined up, close the lid on the laser (or if you don't have one, put on your safety glasses), then press the Start button.

If anything goes wrong, hit the Stop button to abort the job, but if not, let it finish. When it completes, have a look at how things ended up - if the engraving of the name is too deep or too dark, you can increase the speed or reduce the power (or both). If the cut didn't go all the way through, reduce the speed or increase the power (or both). If you don't move

your part, you can run the cut again (possibly with new settings) without having to use a new piece of material..

#### RESULTS AND NEXT STEPS

When it's done, hopefully it looks like something like this:



That's it for this quick tutorial - It's only meant to be a starting point, but hopefully it was enough to give you a little foundation, and a taste of how things work.

#### Next Steps:

We recommend going through some of our "LightBurn Basics" tutorials on YouTube, and we have a great project tutorial that's a little more in depth called the "WIFI QR Code tutorial" that covers more ground, including importing.

- [LightBurn YouTube channel](#)

## Beginner Docs

# 3.3 Downloading & Installing LightBurn

## 3.3.1 Downloading LightBurn

The first step is to go to [lightburnsoftware.com](http://lightburnsoftware.com)

At the top, click "Download and Trial" (or [click here](#))

You'll see links for the current release of LightBurn. Download the version that matches your computer.

- Windows 64-bit - nearly all modern computers are 64 bit
- Windows 32-bit - some older systems might need this
- Mac OSX
- Linux 64-bit

When you've completed the download, you should see the file in your "Downloads" folder. On Windows and Mac you can just double-click the downloaded file.

### Minimum computer system requirements

LightBurn will run on Windows 7.0 or later, 32 or 64 bit, MacOS 10.11 or later, or 64 bit Linux (Ubuntu 16+ or Fedora 28+, anything else may not work as intended).

LightBurn does not require a powerful computer for most work, though if your designs contain a lot of images, more memory is helpful. As with most things, a faster computer will make it easier to work with large images or complex vector graphics.

Choose your operating system:

- [Windows](#)
- [MacOS](#)
- [Linux](#)

## 3.3.2 Windows Installation

Launch the installer by double-clicking it. Windows may ask if you trust us first.

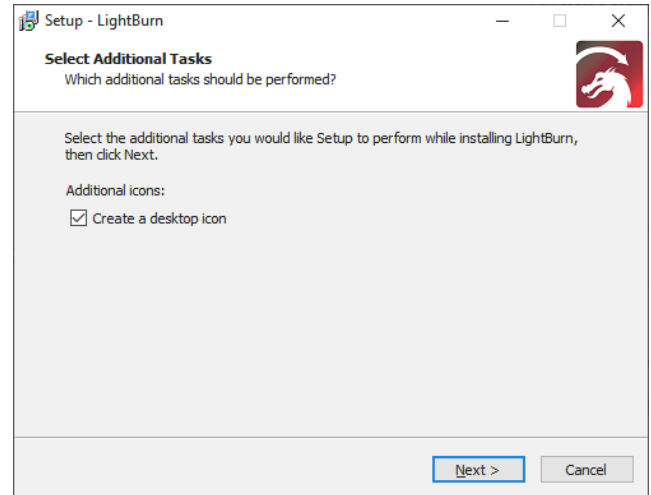

Click Next, then click 'Install'. The installation will proceed. When it completes, you'll see this:

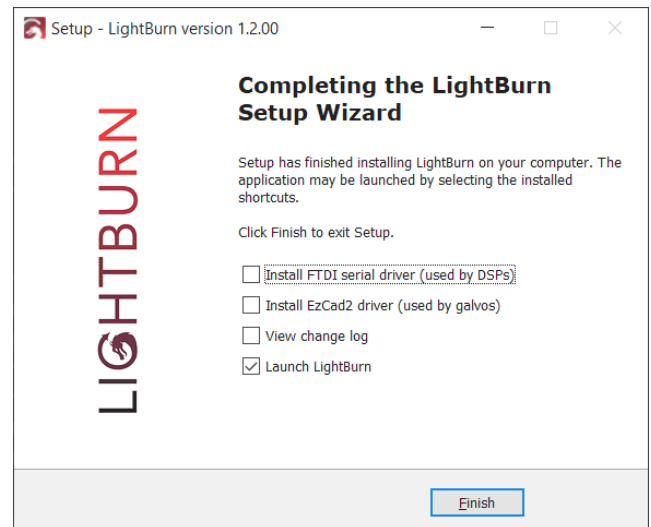

If you have never installed LightBurn before, you might need to check the 'Install FTDI driver' button - this is mostly used by DSP controllers, like Ruida and TopWisdom, and it only needs to be done once. If you update the software later, you do not need to repeat this step.

That's it! Locate the LightBurn icon to launch the program

## 3.3.3 MacOS Installation

Installing LightBurn on Mac is accomplished the same way as most Mac software. After downloading the DMG file, open the file (typically by double-clicking) and drag LightBurn into your Applications folder. As long as you have version 1.2.00 or later, LightBurn should be ready to use. If you're using an

older version, please see the information below for an additional step you'll need to take.



Versions before 1.2.00 were not notarized to be recognized by your computer as coming from a trusted developer. If you installed an older version, you'll need to follow the steps below to allow your computer to run the software:

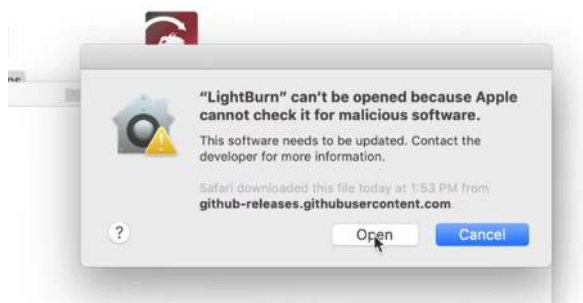

#### macOS Notarization Bypass Guide (fixing the 'unable to check it for malicious software' warning)

To Install the LightBurn application:

1. Double-click the LightBurn.dmg file to mount the disk image.
2. Drag the LightBurn application into your applications folder
3. Eject the LightBurn disk image, or drag it to the trash bin

When launching LightBurn for the first time:

1. Open a Finder window
2. Browse to the 'Applications' folder
3. Hold the Control key and click the LightBurn icon, or right-click or / two-finger tap the icon
4. Choose 'Open' from the menu
5. When MacOS asks if it should open the program, say yes, and it will be listed as an exception in your launcher. From then on you can just launch the application normally.

#### Video Walkthrough

### 3.3.4 Linux Installation



In step 1 below, `$USER` doesn't need to be replaced with your username. It's a standard system variable, and if entered exactly as shown below will automatically refer to the logged-in user's username.

1. Open a terminal and run the following command:
2. `sudo adduser $USER dialout && sudo adduser $USER tty`
3. **IMPORTANT!** Log out and log back in (this refreshes the permissions we just added)
4. Download the Linux 64-bit version, either the `.run` file or the `.7z` file and follow the appropriate steps below:

#### `.RUN` INSTALLER

1. Open your terminal and `cd` to the directory you downloaded the file to.
2. Run `bash ./LightBurn-Linux64-v*.run`
3. It will now automatically install and create a program listing in your desktop environment.

#### `.7Z` INSTALLER

1. Extract the folder wherever you want Lightburn to exist
2. Right click `AppRun` > Properties > Permissions > 'Allow executing file as program'
3. Double click `AppRun` inside your Lightburn folder

### 3.4 LightBurn UI Tour

If you've never used LightBurn before, the main window might seem a little intimidating. Try not to let it scare you - we'll break out the important sections to start with. LightBurn also has some features to make it easier to learn:

- Pop-up tips: If you hover the mouse over a control, you'll see a small bit of text that describes that button or feature, like this:

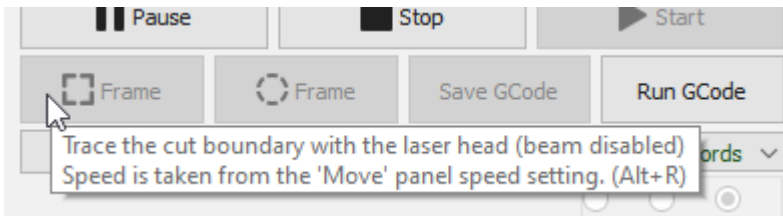

**Help**

If you hover the mouse over something and press the **F1** key (help), LightBurn will launch the help page for that feature in your browser. Most of the panels and buttons on the main window of LightBurn will do this.

#### 3.4.1 The Main Window

This is the default layout for the main LightBurn window:

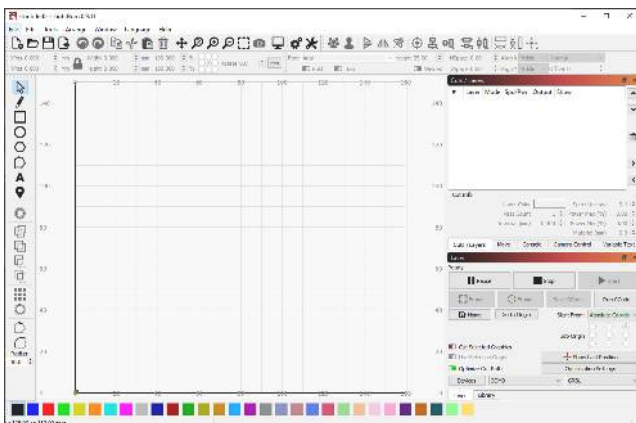

Here it is again, with the sections labeled:

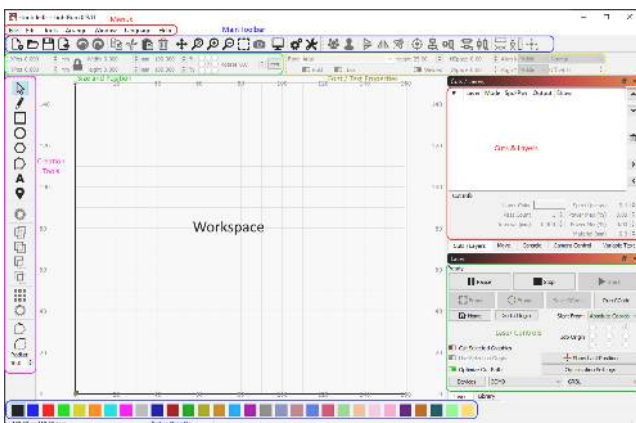

**Open Image**

It's worth noting that along the very bottom of the main display is a status bar that will occasionally show information like an automatic backup in progress, position of the cursor, laser connecting, and so on.

The main sections of the user interface are all linked as chapters, so you can skip around as needed. It's a big application but you don't need to know all of it to use it well!

<b>The Main Window</b>
<b>Menus</b>
<b>Main Toolbar</b>
<b>Creation &amp; Modifier Tools</b>
<b>Color Palette</b>
<b>Tool Layers</b>
<b>Cuts &amp; Layers</b>
<b>Size, Position, Numeric Edits</b>
<b>Font &amp; Text</b>
<b>Laser Window</b>
<b>Workspace / Edit Window</b>

For a full list of the windows and dockables in LightBurn, see the [section on the user interface](#).

These are the windows you will use most commonly, though there are others. If you ever close one accidentally and want it back, go to the menu bar, click the `Window` menu, or just right-click an empty space on the toolbar, and re-enable the window you want back.

### 3.4.2 Menus

Almost all desktop software uses menus in some form. The menu bar at the top of the main window gives you access to almost every feature available in LightBurn.

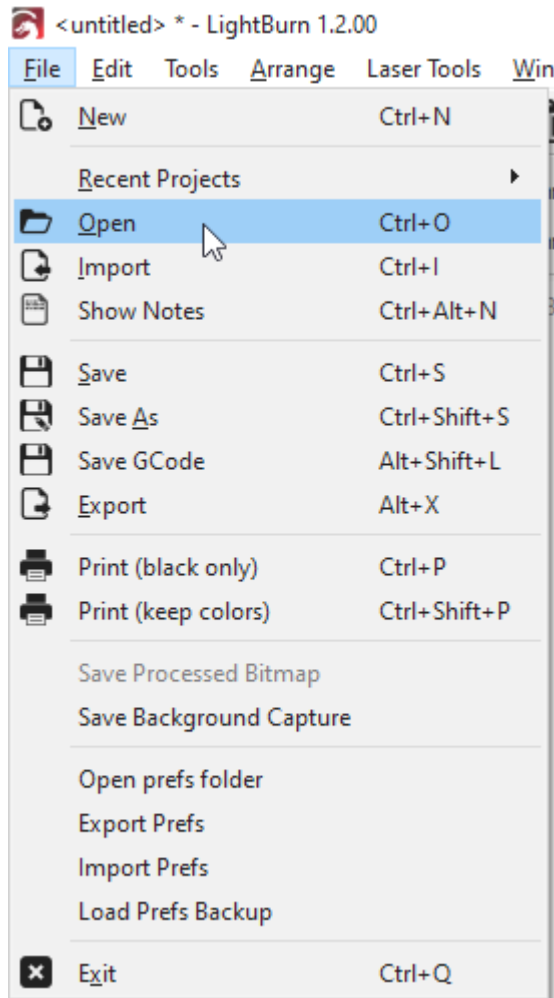

Depending on the operating system you're using the menus might appear a little differently, and some features may be removed if your laser doesn't support them.

If a feature has a shortcut, it will be shown next to it in the menu, as shown above. Learning the shortcuts for the features you use most often will make using LightBurn much faster, and sometimes there are even 'shorter' shortcuts - you can find these in the help menu under `Help > Quick Help and Notes`.

- [Menus in depth](#)

### 3.4.3 Main Toolbar

The main toolbar in LightBurn gives you quick access to commonly used functions for opening or importing files, saving, using the clipboard (copy & paste), moving or zooming the view. Right beside it is the Arrangement toolbar, containing some commonly used arrangement tools for arranging and aligning shapes.



If you aren't sure what a button is for, hover the mouse over it and it will tell you:



- [Main Toolbar in depth](#) (to be completed)
- [Arrangement Toolbar in depth](#)

### 3.4.4 Creation & Modifier Tools

The shape creation tools are normally arranged vertically, but we're showing them sideways here. By default, these are docked along the left side of the work space for quick access.



The first tool, 'Select' is probably the one you'll use most, and is the default tool chosen when LightBurn starts. The others are used to create basic shapes like circles and rectangles, text, and lines, and there are few for modifying shapes in more complicated ways, like merging shapes, or creating lots of copies of shapes.

- [Creation Tools in depth](#)
- [Modifier Tools in depth](#)

### 3.4.5 Color Palette

The color palette lives along the bottom of the main window by default, though a common alternative is docking it next to the creation tools along the left.



Lasers don't "print" in color, so these colors are used to assign different kinds of operations to the shapes in your design. A common convention is to use bright red for cuts, though how you use the colors is up to you.

With nothing selected in the workspace, click a color entry and new shapes will be created in that color. If you have something selected, clicking a color entry will apply that color to the shapes in your selection. The colors currently in use in your design will also appear as entries in the Cuts / Layers window, where you can choose the operations that each color represents.

## TOOL LAYERS

There are 2 special layers at the end of the cut palette, labeled **T1** and **T2**. These are **Tool Layers** and are purely for creating non-output shapes in your designs. These layers have no cut parameters and will never be output to the laser. For example you could use them for:

- Indicating pre-determined material size and position on your machine
- Guide-lines for aligning shapes
- **Text on a Path** (without the path being output)
- **Image Masking**

## 3.4.6 Cuts / Layers

This window shows the colors currently in use in your design, and lets you quickly access the settings assigned to them.

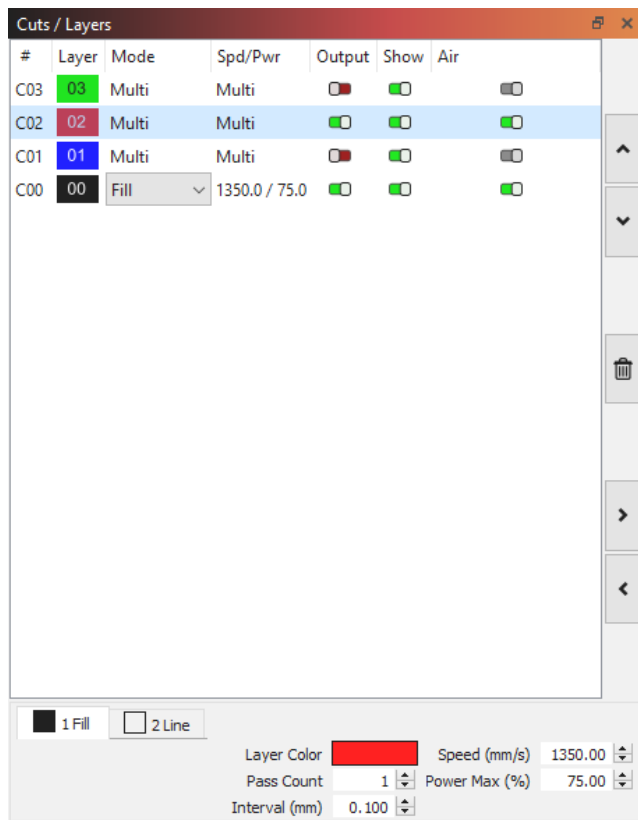

The first column shows the name you've assigned to this layer, followed by the color, then the Mode (Line, Fill, both, or Image). Then the speed and power are displayed, followed by the options to enable or disable sending this layer to the laser, or displaying it in the workspace.

Underneath the layer list you can see and change the basic settings for the currently selected layer. If you double-click an entry in the layer list, it will bring up a larger **Cut Settings Editor**, with a more complete set of options.

- [Cuts / Layers window in depth](#) (to be completed)

## 3.4.7 Size and Position / Numeric Edits

The Numeric Edits toolbar lets you resize, position, and rotate shapes, and change the unit of measure.

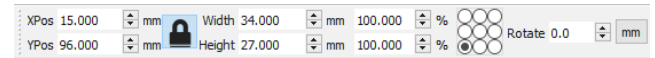

The lock button can be used to maintain the aspect ratio of your objects when changing the size, and the 9-dot control lets you choose the point that positioning and sizing happens from. The number entry boxes accept equations and units, too - You can enter 5mm, 5in, 5", 5\*3mm, and so on, and LightBurn will calculate the correct result for you.

- [Numeric Edits toolbar in depth](#)

## 3.4.8 Fonts and Text controls

The font and text toolbar will activate when you use the 'Create Text' tool, or select text objects.

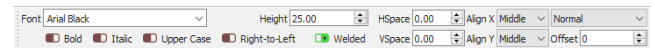

This toolbar lets you change the font, size, spacing, alignment, and automatic welding. It also has settings for variable text options, like serial numbers, dates, and using data tables from a CSV file.

- [Fonts and Text in depth](#)

## 3.4.9 Laser window

The Laser window is used to choose the laser to use, test the position of a file (frame), run or stop the laser, and choose various options that affect how the current file will be processed, ordered, and positioned on the machine.

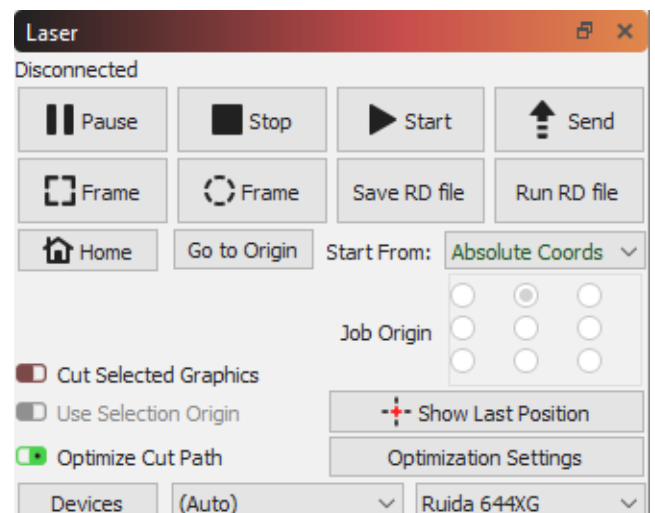

Note that this window may look different for you depending on the type of laser chosen and the options it supports, and some options will be hidden if you are in 'Beginner Mode'.

- [Laser Window in depth](#)

### 3.4.10 Workspace / Edit window

---

Finally, the workspace, or edit window, is the drawing area where you lay out your design. The size of the border and

grid drawn in the workspace matches the available work area on your machine. When you import artwork it is displayed here, and the arrangement of things will match the output sent to your laser.

**Next Step:** [Zooming, Panning, and Selection](#)

## 3.5 Zooming, panning, and selection

The **Edit Window**, the center of the main display, can be moved around and zoomed with the mouse to help you focus on different parts of your design.

### 3.5.1 Zooming

Scrolling the mouse wheel will zoom in or out from the location of the mouse - you can simply point at something with the mouse and scroll the mouse wheel to zoom in on that point. If you have a touch-pad (like a Mac) using a two-finger swipe up or down does the same thing.

You can also use the - and + keys in the upper-right of the keyboard to zoom.

### 3.5.2 Panning

To pan the view, sliding the window around, press and hold the middle mouse button and move the mouse. If you don't have a middle mouse button, you can hold the Space bar on your keyboard down instead - you'll see the mouse

change to a hand , and then you can grab and drag the view with the left mouse button.

There are buttons on the main toolbar for panning and zooming too:



The first button, the four arrows, is the Pan control. Click that to enter Pan mode, to drag the view. You'll see the mouse

cursor change to a hand, like this:  When the hand cursor is visible, you can drag the view around by pressing the left mouse button and moving the mouse. The Space bar acts as a shortcut for the Pan control.

The second button is Zoom to Page - clicking this will reset the view in the workspace to frame the entire work area, which is the view that LightBurn starts with.

The next two buttons are Zoom in and Zoom out. Clicking them will zoom in or out of the center of the view. You can also press the - and + keys in the upper-right of your keyboard for this, or use the mouse wheel.

The 4th button is Frame Selection - Clicking this will zoom the view to focus on whatever is currently selected, or all the shapes in your project if you haven't selected anything.

### 3.5.3 Selection

There are multiple ways to select things in the edit window (workspace). The simplest is to point the mouse at the outline of a shape and click it with the left mouse button.

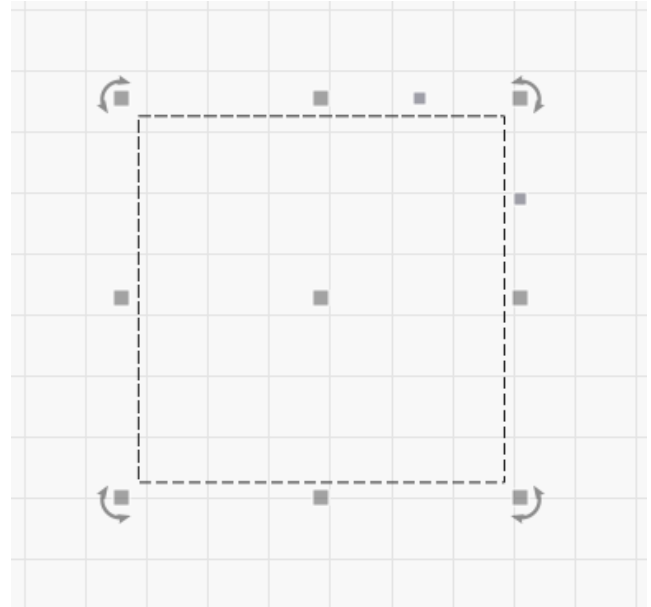

A few things happen when a shape is selected:

1. The selected shape is drawn with an animated pattern instead of solid lines
2. The edit handles for resizing, positioning, skewing, or rotating the selection appear
3. The size and position of your selection is shown in the **Numeric Edits** toolbar
4. Other controls in LightBurn may activate, depending on what you've selected

To clear the current selection, left click an empty space in the view, or press the Esc key.

You can select a collection of shapes by pressing and holding the left mouse button and dragging a rectangle around the things to select, from left to right, like this:

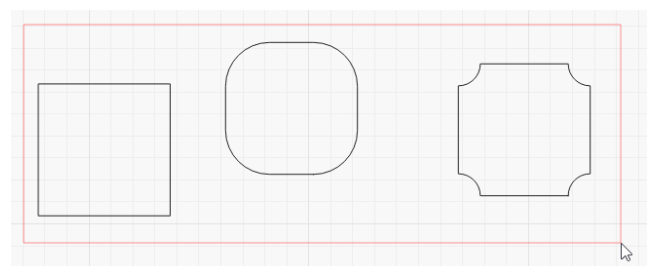

The red rectangle will disappear when you release the mouse button, and all the shapes *fully* enclosed within it will be selected. This is called an enclosing selection - only things fully contained in the red enclosing rectangle will be selected.



You can drag from right to left instead, and this will create a green rectangle, which will select anything that it crosses:

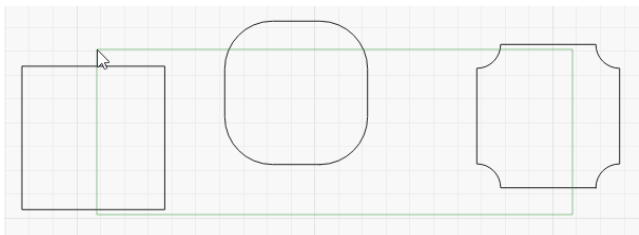

In this case, all three items will be selected even though they are not fully contained by the selection rectangle.

Experiment with these two selection methods - understanding how they work, and when to use them, makes working on larger projects much faster.

### Selection Modifiers

To supplement click-select and rectangle selection, LightBurn supports these modifier keys:

- **⇧ Shift**: Holding Shift while selecting will add the new selection to the current one.
- **(<sup>^</sup>Ctrl / <sup>⌘</sup>Cmd) + ⇧ Shift**: Holding both <sup>^</sup>Ctrl and ⇧ Shift will remove the new selection from the current one.
- **<sup>^</sup>Ctrl / <sup>⌘</sup>Cmd**: Holding <sup>^</sup>Ctrl by itself will toggle the selection state of the new selection.

### Additional Selection Tools

There are also a few items in the Edit menu for special types of selection:

- **Select All**: selects everything in the project

- **Invert Selection**: Anything selected becomes unselected, and anything unselected is now selected
- **Select open shapes**: Selects anything in the design that is an open shape (IE, is not a closed path that forms a continuous loop)
- **Select open shapes set to Fill**: Similar to Select open shapes, but only selects open shapes that are set to 'Fill' - This is useful, because LightBurn is unable to fill shapes that aren't closed, so this can help you find them.
- **Select all shapes in current layer**: If you choose a layer setting and click this option, it will select everything assigned to that layer.
- **Select contained shapes**: this is one you won't use often, but it's incredibly powerful when you need it. Select a single shape in LightBurn, then click 'Select Contained Shapes' to add everything that is 'inside' the item currently selected. For example, if you wanted to select everything inside one of the two blue outlines below, click-select or drag-select would be difficult and time consuming, but 'Select contained shapes' does it in just two clicks:

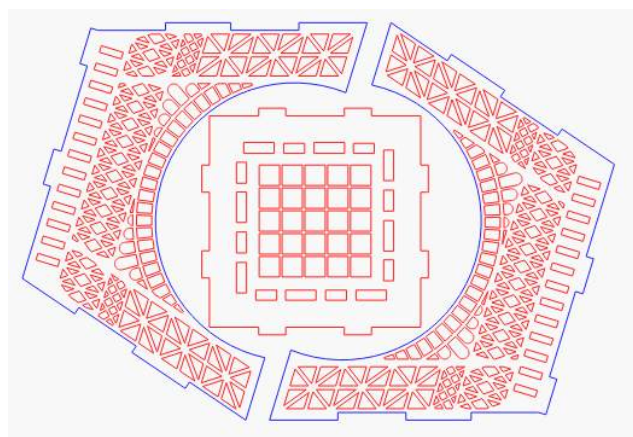

**Next Step:** [Basic Usage - The Essentials](#)

## 3.6 Feature Comparison

Feature	LightBurn	RDWorks	LaserCAD	AutoLaser	LaserWeb
Windows 7, 8, 10	*	*	*	*	*
Mac OSX	*				*
Linux	*				*
64 bit native application	*				
Drag & Drop	*				
Copy & Paste with system clipboard	*				
Undo / Redo	Unlimited	20 steps	Unlimited	30 steps	no
User support forum	*				
CorelDraw macro	*	*	*	*	
Rectangular array tool	*	*	*	*	
Circular array tool	*				
Illustrator import (AI)	*	*	*	*	
PDF import	*			*	
SVG Import	*			*	*
DXF import	*	*	*	*	*
Support for DXF instances	*				
Specify cut start point & direction	*	*	*	*	
Mixed manual / automatic cut order	*				
Automatic Inside / outside cut order	*	*	*	*	
Ruida controller support	*	*			
Trocen controller support	*		*		
TopWisdom controller support	*			*	
GCode controller support	*				*
Integrated webcam support for job placement	*				
Print & Cut registration mark support	*	* (requires RDV controller)			
<b>Image operations</b>					
Image dither modes	7	2	0	2	0
Halftone image generation	*	*		*	
Transparent bitmap support	*				
Brightness / Contrast image controls	*	*	*	*	
Image edge enhancement	*				

<b>Feature</b>	<b>LightBurn</b>	<b>RDWorks</b>	<b>LaserCAD</b>	<b>AutoLaser</b>	<b>LaserWeb</b>
Vectorize image (trace)	*	*		*	
Crop / Mask images	*				
<b>Vector Operations</b>					
Create and edit vector graphics in-app	*	*	*	*	
Vector shape node-level editing	*	*	*	*	
Automatic text welding	*				
Boolean operations (union, subtract, weld)	*				
Shape offsetting	*	* (poor)	* (poor)	* (poor)	
Welded offsets	*				
Multiple offset corner types (round / sharp / beveled)	*				
Use objects as guides	*				
Create rectangles with rounded corners	*				
Fillet shape corners	*				
Multiple object selection modes (crossing, enclosing)	*				
Fully simulated preview	*	*			
<b>Text / Font Operations</b>					
TrueType font support	*	*	*	*	
SHX font support	*	*	*	*	
Apply text to curved path	*				
Bend text	*				
<b>Engraving operations</b>					
Ramp generation (for stamp making)	*	*	*	*	
Material Settings Library	*	*			
Rotary engraving support	*	*	*	*	*
Tool path preview	*	*	*	*	*
Move laser to graphic position	*				
Move graphic to laser position	*				
Jog laser by clicking in page	*				
Jog laser with numeric keypad	*				*

## 4. Primary Docs

---

### 4.1 Tips and Tricks

---

LightBurn has a decent number of user interface tricks that aren't always obvious, so we're listing many of them here. We also have a Hotkey reference guide [here](#).

#### Pop-up tips

Nearly everything in LightBurn has pop-up text that will tell you what the control is for, and sometimes gives additional help, like this:

---

#### Topic-aware help function

If you point the mouse cursor at a button or window and press **F1** (help), LightBurn will launch your browser and open the documentation on the relevant help page for that control. This works for nearly all controls on the main window.

---

#### Reset the window layout

Sometimes a window gets shoved off the screen or positioned in a way that makes it hard to find, or move. You can reset the window layout in LightBurn in two different ways:

- In the Window menu, choose "Reset to default layout". This will undock all windows, and re-dock them in the default order.
  - If that doesn't do it, restart LightBurn while holding the +shift++ - this skips restoring the saved window layout, and always works.
- 

#### Edit window shortcuts

The edit window has a number of single-key shortcuts that are only active when you have clicked in the edit window. They are:

- **H** - flip selection horizontally
  - **V** - flip selection vertically
  - **L**, **R**, **T**, **B** - Align the selected objects by Left, Right, Top, or Bottom edges
  - **C** - Align the selected objects along their vertical centerlines
  - **E** - Align the selected objects along their horizontal centerlines
  - **P** - Move the selection to the center of the page
  - Arrow keys - Move the selection (Shift and Ctrl adjust the size of the move)
  - (comma) and (decimal), usually under < and >, are rotate 90 counterclockwise and clockwise
  - Holding Shift while pressing , (comma) and . (decimal) will rotate 45 degrees
  - **Tab** - Select the next shape in the shape list
  - Number pad arrows - Jog the laser
- 

#### Framing Mode Nudging

While framing, the arrow keys can be used to nudge the position of your graphics by 1mm. Holding Shift will increase the movement distance to 5mm, and holding Ctrl will decrease it to 0.2mm.

#### Equation support in number boxes

The position, width, and height boxes in LightBurn will accept not just numbers, but also measurements and equations. All of these are valid:

- 50mm, 5cm
- 10 in, 10"
- 2 ft, 2'
- 10.25 / 2
- $(10+2) * 4 + 1\text{in}$

You can also use the constants  $e$  and  $\pi$ , and functions like  $\sin$ ,  $\cos$ ,  $\tan$ ,  $\sqrt{\phantom{x}}$ ,  $\text{abs}$ ,  $\text{atan}$ ,  $\log$ ,  $\text{pow}$ , and more.

---

### Copy & Paste from other applications

LightBurn can paste data in known formats from other applications.

- An image copied from a browser can be pasted into LightBurn
  - Text copied from anywhere can be pasted into LightBurn
  - Shapes copied from Inkscape can be pasted into LightBurn
- 

### Drag & Drop from the file browser

Files in any format supported by LightBurn can be dragged into LightBurn from your file browser (Windows file explorer, or Finder on MacOS).

---

### Automatic file backups

LightBurn by default will save backups of whatever file you are working on. If you have previously saved the file as a LightBurn project, the backup will be stored in the same folder, with the same name, but with "\_backup" appended to it.

If you haven't saved the file with a name yet, LightBurn will store the backups for it in your Documents folder with the name "AutoSave\_xxxx" where the x's are a random string of characters. If LightBurn crashes, you can usually open the most recent of these files to recover your work.

---

### Auto-Start a job after Sending it to the laser

Hold the Shift key when you click the **Send** button in LightBurn to, and LightBurn will automatically run the file on the laser when the send is completed. This is useful if you are sending very complex or large files, and want to be certain that the transfer completes before the job starts running, but saves you having to press **Start** on the controller.

---

### Pause and stop from the keyboard

While your laser is running, you can use your keyboard's **Pause** key to pause the laser and **^ Ctrl + Break** to stop it. **Break** is typically on the same key as **Pause**, but more compact keyboards may not have this key.

## 4.2 Installation & Licensing

### Primary Docs

#### 4.2.1 Trial or License Activation

If you've never used LightBurn before, you'll be shown the License and Trial page first. Here you can either enter and activate a license key if you have one, or you can activate a free 30 day trial by clicking "Activate Trial".

If you already have a license key, be sure to enter it *exactly*, including the dashes, into the box labeled 'License Key' then click the 'Activate License' button below it. We recommend just copying the key and pasting it into the License Key box.

If you do not have an internet connection on the computer you will be running LightBurn on, please follow the [Offline Activation](#) instructions.

You can get back to this screen in LightBurn at any time by going to the menu and clicking Help > License Management.

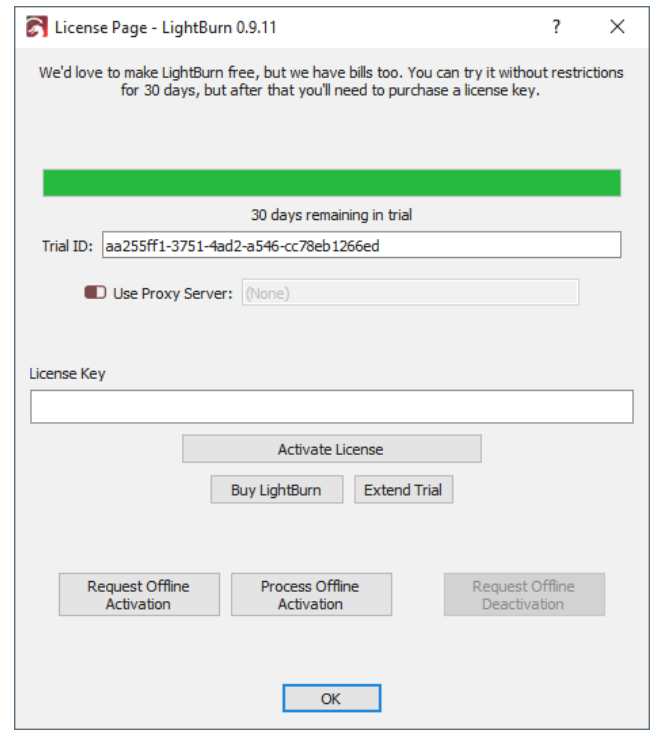

Once you have activated your license or the trial, click 'OK'

If you ever need to manage your license, such as deactivate an old computer, follow the instructions on the [License Management](#) page.

The next thing you'll see is the 'General Usage Notes' page - this is a brief help page just to get you going. You can get back to it any time in the Help menu, under Help > Quick Help and Notes. Click OK.

You're almost done!

**Next Step:** [Adding your Laser to Lightburn](#)

## Primary Docs

### 4.2.2 License Management

The license system used by LightBurn has a web portal that you can use to view the computers on their license, and do some basic tasks like remove a computer that has failed and process an offline activation.

If you purchased your key from LightBurn directly, you will have access to this portal. If you purchased from a 3rd party vendor, we would need to assign your license key to your email address for you to use this. Contact us via email ([support@lightburnsoftware.com](mailto:support@lightburnsoftware.com)) **with your full name and license key** to have us do this.

To access the license portal, go to <http://lightburn.cryptlex.app>

The first time you use the portal you will need to request a password reset. Click 'Forgot Password', enter the email address where you received your license key, and click 'Recover Password'. You will receive an email from Cryptlex with a password reset link. Follow the link, choose your new password, then log in.

If you do not see it, please check your Promotions or Spam folders as the password reset email sometimes ends up there. If you still cannot find it, then your email provider might be blocking the email from ever reaching you to begin with - some email providers do this. We know Gmail works well, and if you provide a Gmail account, we can put your key under that instead so that you can access the portal. In this case, contact us via **email** with your full name and license key.

#### REMOVING AN OLD COMPUTER FROM YOUR KEY:

On the main screen you will see any licenses associated with your email address, like this:



ID	Name	Status	Activation Key	Last Used
...	...	Active	...	...
...	...	Expired	...	...

Clicking on "#/# Activations" next to a license will show which computers are assigned to your license key, when they were activated and last used, etc, like this:

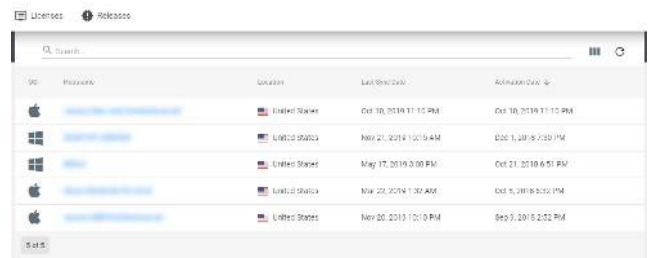

ID	Platform	Location	Last Seen	Activation Key
...	...	United States	...	...
...	...	United States	...	...
...	...	United States	...	...
...	...	United States	...	...

Clicking one of the computers will show additional details, and displays this icon in the upper-right:



Click that, and you have the option to delete an activation, removing the license from that computer, and freeing up the license seat for use on another machine.

#### OFFLINE ACTIVATION

If you would like to license a computer without a network connection, enter the license key, then click "Request Offline Activation". It will ask you to save a file that contains the machine fingerprint as an offline request. Copy that to a USB flash drive and bring it to a machine with a network connection.

To do offline activation from the portal, open the .ofr file in a text editor (Sublime Text or Notepad++ work nicely) and copy the entire string. With your license being viewed, click 'Activations', then 'Offline Activation', and paste the copied OFR content into the request box in the Cryptlex portal. This will produce the .dat response file which is what you will put back into the offline LightBurn system.

If you're not comfortable doing this yourself, you can **email** the .ofr file **and your license key** to us, and we will process and return the .dat response file that you use to complete the activation.

If you're trying to run the trial, there isn't currently a way to register the trial without an internet connection. It only needs to be connected long enough to verify that the machine hasn't run the trial before, and doesn't require the connection after that.

## 4.3 Adding A Laser

---

**Beginner Docs**   **First Steps**

### 4.3.1 Laser Types

There are many types of laser cutters and engravers that are compatible with LightBurn, let's talk about a few of them.

#### Diode Lasers

These devices typically share a lot of design with 3D printers, and are equipped with a small, fairly low-power diode laser module. These devices can usually cut thin pieces of wood or plastics, but are far more often used to engrave wood or plastic surfaces with a design.

**chine Guides**

**Sculpfun S9 Limit Switch Guide**

**Sculpfun S9 Flashing GRBL Guide**

#### CO<sub>2</sub> Lasers

These devices use a CO<sub>2</sub> beam to cut through thicker pieces of wood, plastics, or other organic materials. While there are "galvo" style CO<sub>2</sub> laser cutters, most of these are gantry

style, where the beam is "moved" about the cutting area with a gantry system. Many of these lasers use a glass tube filled with gas to produce the beam, hence the name.

**chine Guides**

**3018/"CNC" Guide**

**Ruida Ethernet Guide**

**Trocen Ethernet Guide**

#### Galvo Lasers

These devices have a fixed galvo head responsible for actuating mirrors to move the beam, and usually have an external box responsible for generating a beam. This beam is produced by a CO<sub>2</sub> or Fiber source to engrave, color, or occasionally cut pieces of metal or glass.

**chine Guides**

**JCZ/Galvo Guide**



## 4.3.2 Adding A Laser

**Primary Docs**   **First Steps**

### Find My Laser

In the Devices page, click the 'Find My Laser' button, and you'll see this screen:

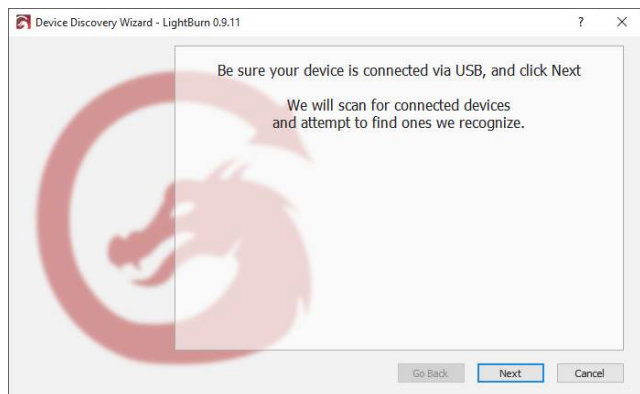

Make sure your laser is powered on, connected to your computer with a USB cable, and has completed any startup sequence it needs to, like homing. When the laser is ready, click Next.

After a short scan, LightBurn will list the devices it was able to recognize:

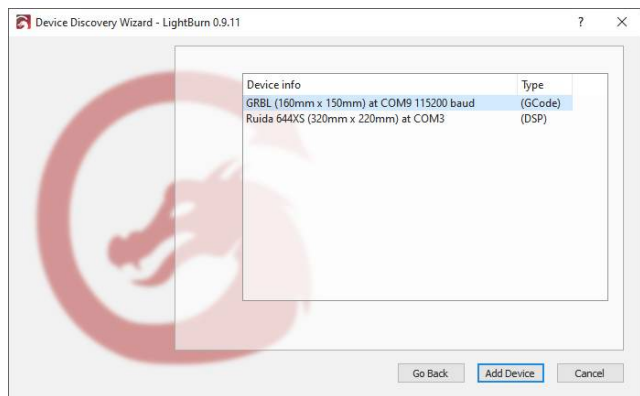

In the above image, I have two lasers connected to my computer - the first, a GRBL controller on COM9, and the second, a Ruida DSP controller on COM3. Select your laser and click 'Add Device'.

Is your laser a **GCode**, **DSP**, or **Galvo** device? What if it **wasn't found**?

### GCODE DEVICES

If you have a GCode controller, you'll be asked if your machine is an X-Carve or Shapeoko, because there are some specific settings that need to be configured for those machines. If you have one, click the appropriate button, if not, click 'Other'. You may be asked where the origin of your machine is, and if you want to home on startup. Nearly all GCode systems use the front-left as the origin.

If your machine has homing or limit switches, enable the homing on startup, otherwise leave it off. If you see `Error: 9` in the console later, it means you've enabled this feature, but your machine isn't configured for homing.

With some GCode devices, additional configuration of either LightBurn or the controller may be necessary.

**Next:** [Connecting to the Laser](#)

### DSP DEVICES

If you have a DSP controller, the next screen will ask you where your machine origin is. This is the corner the machine goes to when looking for the homing switches when it powers up. Click the home corner. If you get it wrong, things may be backwards or upside down, but don't worry - you can easily change it later.

When your laser is added, click 'OK' on the Devices page to exit.

**Next:** [Software walk-through for beginners](#)

### GALVO DEVICES

Galvo devices have a few more steps comparatively, where LightBurn will attempt to import the markcfg7 file from your EZCAD2 setup. Select the location, enter your workspace size, and you'll be done. See the [Galvo Setup](#) page for a step-by-step on completing these steps.

**Next:** [Software walk-through for beginners](#)

### WHAT IF MY LASER ISN'T FOUND?

If LightBurn can't find your laser, it could be for a number of reasons:

- **Missing drivers** - If your laser came with its own software or drivers, install it. Even if you don't plan to use it, sometimes they contain necessary drivers that aren't included with LightBurn.
- In the case of galvo devices, they have a LightBurn specific driver that needs to be used. See [here](#) for more information.
- **Can't connect** - Only one application can talk to your laser at once. If you run other software, like RDWorks, Easel, Carbide Create, AutoLaser, LaserCAD, etc, make sure that software is not running when you run LightBurn.
- **Networked device** - LightBurn can't automatically configure a network-connected laser. For this, you'll have to click '[Create Manually](#)' and follow the steps.
- **Marlin controller** - If you are using a Marlin controller, they have a variety of baud rates and configuration options, and they take significantly longer to reset than most other controllers, so it's not practical to auto-search for them - click '[Create Manually](#)' and follow the steps.

## Manually adding a Laser

If LightBurn can't automatically add your laser, because it's not connected to your computer, or is connected over a network, you can click the 'Create Manually' on the Devices page.

### don't have a laser right now!

If you don't have a laser hooked up to your computer, you can create a laser manually as shown below, using your best guess for the settings. If you have a specific laser in mind, you can look up the appropriate settings for it in that machine's support.

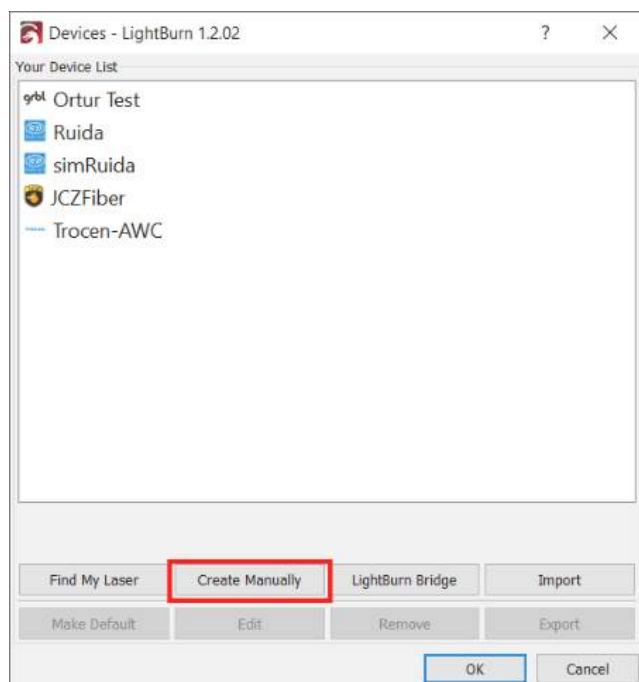

### Device type:

LightBurn will open the New Device Wizard, and the first thing you'll see is a list of the controllers supported by your version of LightBurn:

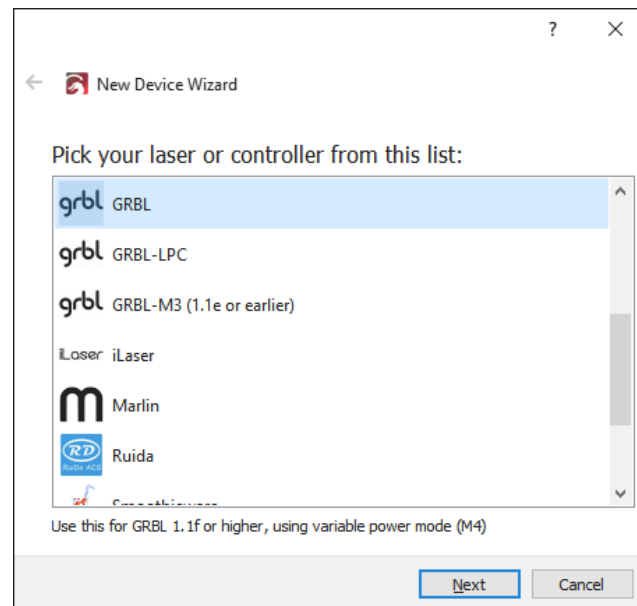

Choose the entry that matches the type of controller or firmware in your laser and click Next.

### Connection type:

The next step is choosing how you connect to your laser. The choices you see will depend on the type of connection methods supported by your controller and LightBurn. Serial/USB is the most common. Some controllers allow connection by Ethernet (note that this includes both WIFI and wired).

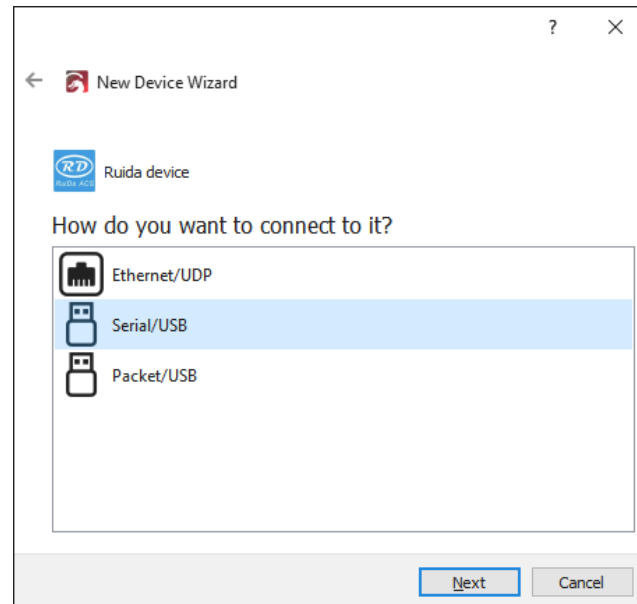

Choose how you wish to connect, and click Next.

### Name and work area size:

You can name the laser, which is very useful if you have more than one, or just leave it as is.

You *must* set the size of the work area for your laser so that LightBurn can make try to prevent things from going out of bounds. If you don't know the exact size, you can easily change this later in the [Device Settings](#) page.

#### Laser Origin and homing:

The origin setting is where the 'zero' point of your X & Y axis meet. If you get this wrong, you can change it later in the [Device Settings](#) page. This setting also controls the orientation of the output - if it's wrong, the output from your laser may be mirrored or upside down.

If you have a GCode based controller, like GRBL, Smoothieware, or Marlin, commonly used with diode lasers or smaller hobby systems, in almost all cases the origin will be in the front-left. With GCode based systems, you are given the option to send the homing command when LightBurn first connects. If your laser does not have homing switches, leave this off.

If you have a DSP controller, like Ruida, Trocen, or TopWisdom, common in larger CO<sub>2</sub> lasers with metal cabinets and LCD displays, the origin corner will be the corner that the laser head seeks out when you power it up. With DSP controllers, the controller will automatically home itself when powered up, so you will not see the option for homing on startup.

#### All done!

That's it - The final page will show you a summary of your choices. You can go back and fix anything if necessary, or click Finish to create the new device entry.

#### Next Step: [Connecting to the Laser](#)

## Primary Docs    LightBurn Bridge

### LightBurn Bridge

The LightBurn Bridge was created by LightBurn to get around some of the limitations of Ruida controllers. Ruida uses the UDP network protocol, which does not guarantee data transmission, and is therefore not reliable enough to use over WIFI. Many computers no longer have a network port, and running a network cable is often impractical or cumbersome. In addition, Apple's device driver for the USB connection to the Ruida has issues that often cause data loss.

The LightBurn Bridge overcomes all of this. It's a Raspberry Pi running software created by LightBurn to act as a relay between your PC and laser. You connect to it using TCP, so the commands are reliably sent even over WIFI. The Bridge forwards the commands to the controller using a short network cable, and relays responses back to your computer.

The LightBurn Bridge is simple to configure, requires no drivers, and typically sends data 50% to 100% faster than a USB connection. It looks like this:

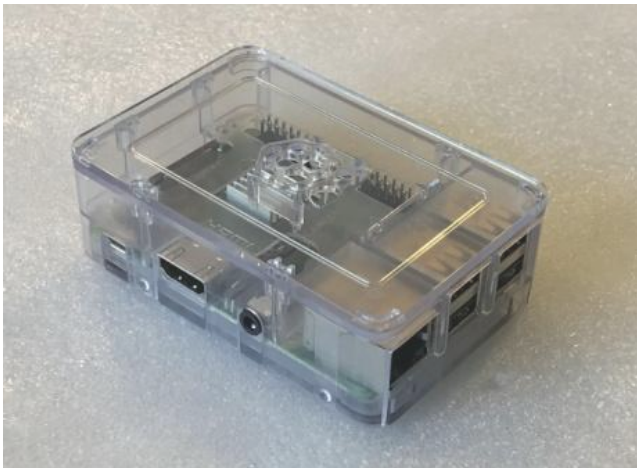

If you purchased a kit with everything included, continue below. But if you want to setup your own with a Raspberry Pi you already have, follow the [SD card flashing instructions](#) first.

#### **Danger**

The bridge is intended to be an appliance. We have tested the software extensively, but we do not support modifications to the hardware or firmware - if you alter the system to add functionality beyond what is covered here, or in the [Advanced Guide](#), you're on your own.

#### LIGHTBURN BRIDGE SETUP

The LightBurn Bridge is pre-configured to connect to a laser configured with an IP address of **10.0.3.3**. In the Ruida control panel, set the IP of your laser to this value, then connect a network cable from the controller to the Raspberry Pi, and plug in the Pi with its power adapter. If you need to change the IP address, please check out the [Configuration](#)

[Options](#), and please note the caveats to doing this, listed there.

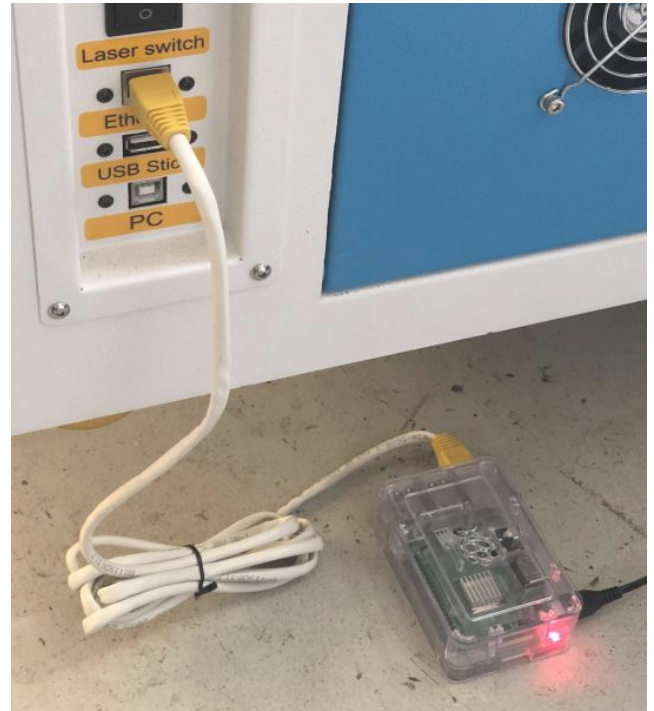

In LightBurn, in the Devices screen, click 'LightBurn Bridge' to set it up:

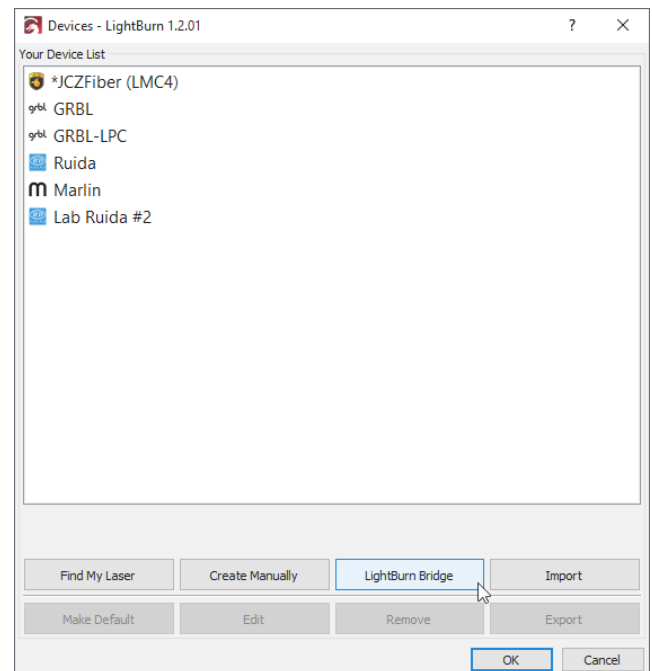

#### Connecting the LightBurn Bridge to your network

LightBurn will open the LightBurn Bridge discovery wizard to guide you through the setup.



On your computer or a mobile device, use the WiFi settings to find the LightBurn Bridge device, and connect to it:

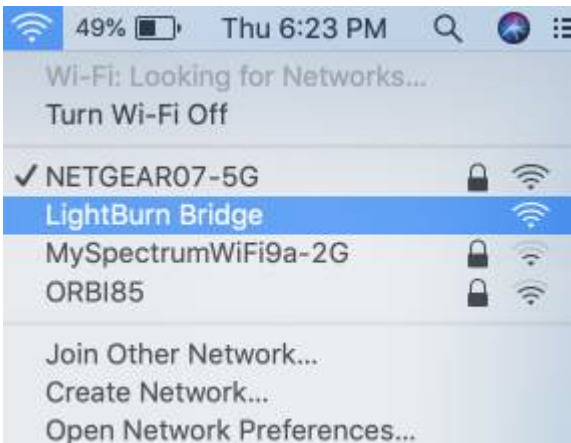
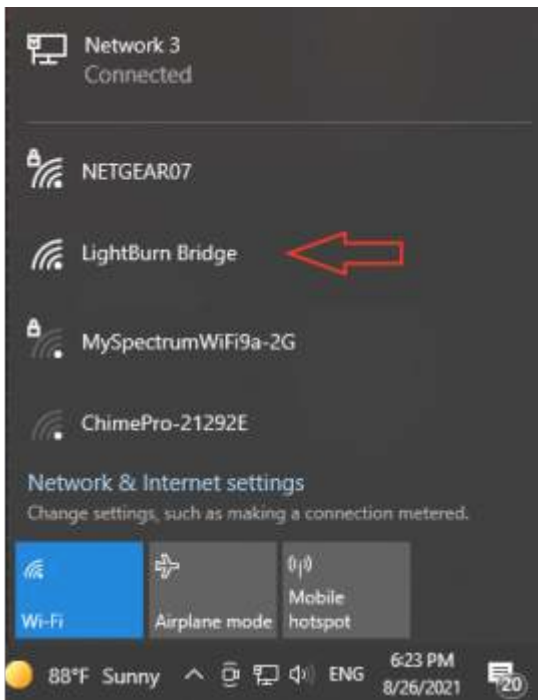

**Note:** The access point name you find will typically have a four-character random string at the end of the name, such as LightBurn Bridge E4B7. This is to prevent conflicts if you have multiple LightBurn Bridge devices in the same location.

When you've selected the LightBurn Bridge access point, click Next.

**Note:** You may also configure the WiFi manually, as shown on the [Advanced Usage](#) page.

**Configuring the Bridge in LightBurn**

Now you need to tell the LightBurn Bridge which WiFi network to connect to, and give it the network password. In most cases, the configuration page on the Bridge will open automatically. If it does not, browse to <http://192.168.42.1> as shown in the wizard page below. If you want to use your PC to configure the Bridge, click the button shown to open your browser to the correct page:



**Setting the WiFi name and password**

In the browser window, you'll see a page like this:

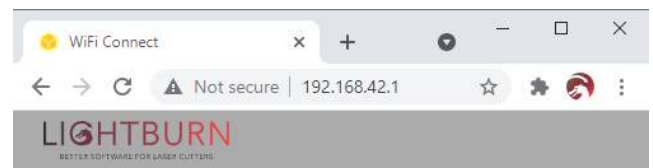

Hi! Please choose your WiFi from the list

SSID\*

NETGEAR07

Passphrase

Connect

Select your WiFi network from the list of options, enter your password, then click the 'Connect' button at the bottom. You'll see a message appear near the top, telling you that the bridge is connecting to your WiFi network. You can now close the browser window and go back to the LightBurn wizard.

If you were using your PC to configure the LightBurn Bridge, re-connect the PC to your WiFi network if you need to.

### Finding the LightBurn Bridge from your PC

LightBurn will now scan your network, looking for connected devices, to find the new LightBurn Bridge. You'll see a progress bar appear as it does this:

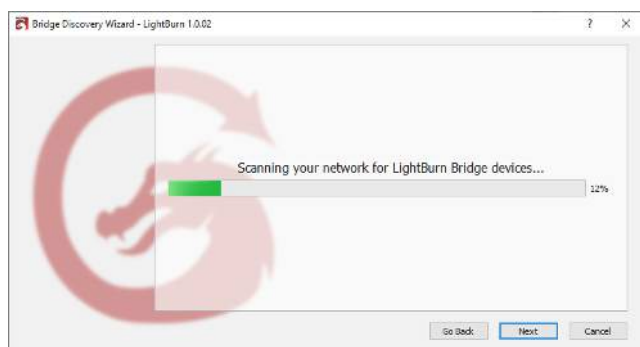

If LightBurn is able to connect to the Bridge device, and the Bridge was able to talk to your laser, you should see something like this:



If everything looks good, click 'Add Device' and you'll be taken to the setup screen for the device, asking you to enter the name, check the size, and so on. [Click here to skip to the next section.](#)

If either the Bridge or the laser are not found, you may need to change the IP address on your laser to 10.0.3.3 (the default for the LightBurn Bridge), or optionally, you can configure the bridge to use a different address for your laser.

#### Name and work area size

You can name the laser, which is very useful if you have more than one, or just leave it as is.

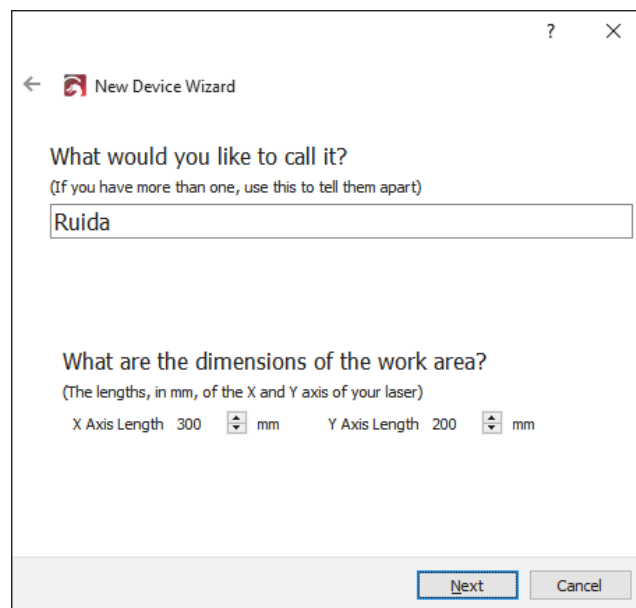

You *must* set the size of the work area for your laser so that LightBurn can try to prevent things from going out of bounds. If you don't know the exact size, you can easily change this later in the [Device Settings](#) page.

#### Laser Origin

The origin setting is where the 'zero' point of your X & Y axis meet. If you get this wrong, you can change it later in the [Device Settings](#) page. This setting also controls the orientation of the output - if it's wrong, the output from your laser may be mirrored or upside down.

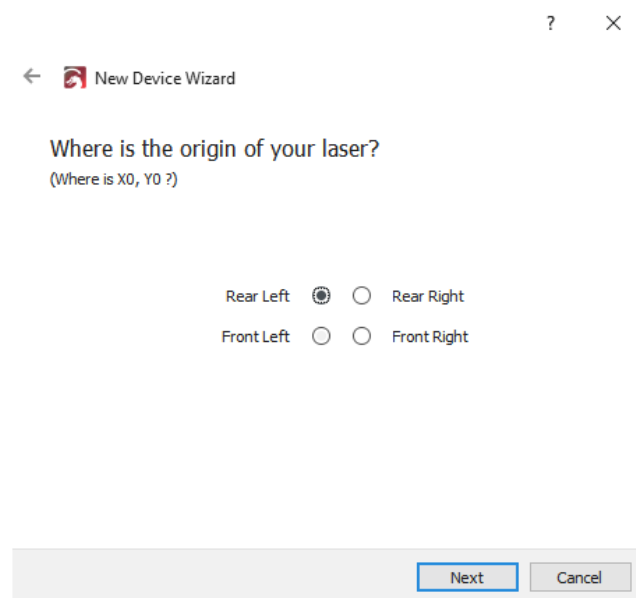

With a DSP controller, like Ruida, Trocen, or TopWisdom, the origin corner will be the corner that the laser head seeks out when you power it up.

#### All done!

That's it - The final page will show you a summary of your choices. You can go back and fix anything if necessary, or click Finish to create the new device entry.

? ×

←  New Device Wizard

That's it - you're done. Here's a summary:



### Ruida 6445G (Bridge)

310mm x 220mm, origin at rear left

10.0.0.11

Click "Finish" to add the new device.

Finish

Cancel

#### Next Steps

If your use of LightBurn Bridge is more complex than indicated here, you may need to take a look at our [Advanced Guide](#) for LightBurn Bridge.

### 4.3.3 Connecting to the Laser

Once you have **added your laser** to LightBurn, it should appear in the list of devices to the right of the 'Devices' button in the Laser Window. If you only have a single laser, it will be automatically chosen for you.

If you have more than one laser set up, you might need to select the one to connect to by clicking here:

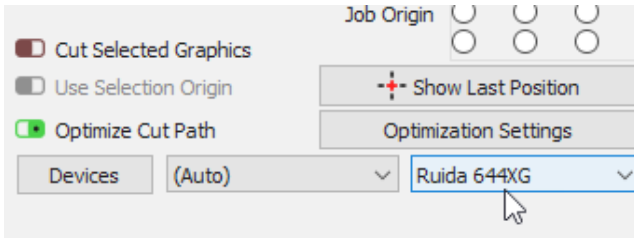

Depending on the type of controller you have, you might have to manually choose the port that the laser is connected to, by clicking where you see '(Choose)' in the Laser Window:

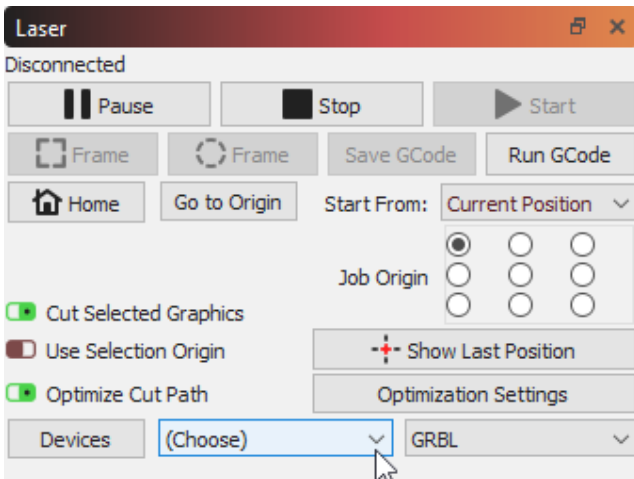

As long as your laser is connected to the same communication port, LightBurn will reconnect when you restart. If you reboot your computer, or plug the controller into a different USB port, you might need to re-select it.

If you see the '(Choose)' as shown above, you need to select the port. If no ports are listed in the drop-down, it means that no devices were found, which could mean that it is not plugged in correctly, isn't powered, or you're missing a driver.

If your laser disconnects for some reason, or enters an alarm state and needs to be reset, you can quickly re-connect by right-clicking the 'Devices' button in the Laser Window.



## 4.4 Configuring A Laser

### Primary Docs **GRBL**

#### 4.4.1 Common Grbl Setups

If you have a GCode-based system, like a Shapeoko, Eleksmaker, X-Carve, or Acro system, you might need to make some simple changes to get the most from LightBurn.

##### Quick Reference

- You might need to adjust your spindle max RPM value ( `$30` ) to match the LightBurn default (1000) or vice versa. The value in LightBurn is called "S-Value Max", in the [Device Settings](#).
- You might need to enable "Laser Mode" if you have GRBL 1.1f or later ( `$32=1` )
- If you have an older version of GRBL (prior to 1.1f) it's highly recommended to upgrade the firmware, as Laser Mode also prevents the machine from pausing with every power change. The pause, which happens on older versions, or when not using Laser Mode, will cause excessive burn spots when engraving images.
- If your machine uses negative workspace coordinates you'll need to apply a workspace offset ( `G10 L2 P1 xx yy` ).
- Set your machine status reporting to be relative to the workspace origin, not the machine origin ( `$10=0` ).
- Make sure the controller is reporting positions in mm, as expected by LightBurn ( `$13=0` )
- If your machine does not have homing switches (also called limit switches) you will need to home it manually if you want to use Absolute Coords or User Origin modes

##### Grbl Flavors

Grbl firmware was originally designed for CNC machines and 3D printers, with laser support added more recently. It is highly configurable, and this is both a blessing and a curse. The "standard" way a CNC machine is configured is somewhat different from the way laser machines often are. Luckily this is easy to change, and easy to switch from one to the other.

The more recent versions of Grbl (1.1f and up) support two things that are incredibly useful for lasers. The first is Laser Mode, enabled by setting `$32=1` in the firmware settings. Laser mode eliminates the pauses that happen when changing power output, because Grbl knows it's controlling a laser which reacts instantly, instead of waiting for a spindle to change RPM.

The second is a feature called variable power mode, or the M4 command. In this mode, Grbl adjusts the laser power as the machine speeds up and slows down, making for very consistent cutting and marking. Older versions of Grbl do not have this feature, and simply run the laser at a constant power output for the duration of a cut. Since the machine

needs to slow down to take sharp corners, this means corners get over-burnt, while long straight lines end up lighter.

This also has the benefit that when the laser comes to a complete stop, the beam turns off (zero speed equals zero power), meaning that pausing a job automatically turns off the laser. This is not always true with other versions of Grbl.

If you aren't already running Grbl 1.1f (or later) on your controller, we highly recommend it for laser use. If this isn't an option, that's ok, but your results won't be as good, and pausing the laser runs the risk of leaving the beam on and ruining the job.

##### Getting Machine Settings

Many GRBL based machines allow the settings of the machine to be easily exported or viewed. For advanced configuration like adding limit switches, updating firmware, or setting up a new controller, you'll need to interact with these values. LightBurn makes this easy to do by using the Console window or the Machine Settings window to copy, update, or reset your Machine Settings.

Opening the [Machine Settings](#) window allows you to more concisely see the parameters labeled for you. You can from this window, also export them to a file for later restoration, like we did in our GRBL flashing guide [here](#).

In the [Console](#), enter `$$` to ask the controller to return to you the machine's configuration in that window. This is often easier to do, as it avoids any potential of LightBurn not knowing custom configuration a vendor may have made.

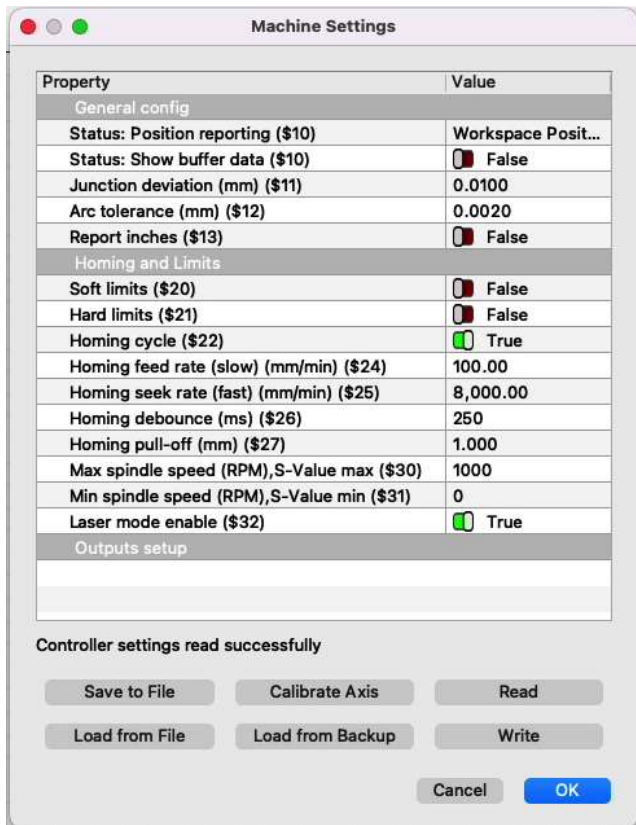

### Shapeoko, XCarve, and other negative workspace systems

Shapeoko machines typically use Grbl 1.1f, as do newer X-Carve and some other systems, but as they are designed as CNC machines, they are typically configured for negative workspace coordinates, which LightBurn doesn't support. This is an easy thing to work around though, using a workspace offset.

We'll use a Shapeoko XXL as our example setup. This machine has an 812mm x 812mm working area, and the origin is set to the rear-right, with negative numbers going down and to the left (onto our workspace). We're going to leave the direction alone, but change the origin position by using this command in the LightBurn Console window:

```
G10 L2 P1 X-812 Y-812
```

That command says "set an offset" (`G10 L2`) in the first coordinate system (`P1`) of `X -812` and `Y -812`. (If your machine is a different size, use your width and height values in mm instead of the 812's shown here, and remember the minus signs - those are important)

This shifts the origin point of the machine left and forward by the size of the workspace. Then you tell LightBurn that the origin is at the front-left of the machine, instead of the rear-right, and you're done.

When you want to go back to using your machine for CNC use, clear the offset with:

```
G10 L2 P1 X0 Y0
```

It is simple to set these up as macro buttons in the LightBurn console window. Enter the first command into a macro and call it "Use Laser", and enter the second command into a different macro and call it "Use CNC". When you want to use your laser, click the "User Laser" macro button, and when you're done and want to switch back to CNC, click the "Use CNC" button.

After setting this, you will also need to make sure your machine is reporting coordinates relative to this workspace origin, instead of the absolute machine zero. Do this by entering `$10=0` in the console.

### X-CARVE

X-Carve machines sold prior to January 2018 generally run an older flavor of Grbl (1.0c) which does not support the variable power (`M4`) command, meaning you'll need to use the Grbl-M3 device in LightBurn. Machines sold after that date use Grbl 1.1f, and will work with the standard Grbl device in LightBurn if the following settings commands are entered in the console:

```
$30=1000
$32=1
```

These two lines:

- Set the spindle max value (`$30`) to match LightBurn and Grbl's default setting (1000)
- Enable laser mode (`$32=1`)

### OTHER MACHINES

If you aren't sure how to configure your machine, there are some simple steps to take that can help. First, figure out which firmware you're running. In LightBurn, when you first connect to the machine, the console window will usually show a 'hello' message from the controller. For Smoothieware boards it's just "Smoothie". For Grbl, it will be "Grbl 1.1f [\$ for help]" or similar - this tells you it's Grbl, and which version. Machines using Grbl 1.1f or later will support the `M4` variable power command, and just use the "Grbl" driver in LightBurn. Grbl 1.1e or older (Grbl 1.0, Grbl 0.9, etc) must use the Grbl-M3 device in LightBurn.

With the driver identified, it's time to find the machine origin. First, home the machine by pressing the Home button



() on the Move window.

In the console window, type

```
G0 X0 Y0
```

then hit enter. Your machine will head toward its origin position. This isn't always the same as where the home position is. Usually the home position is in one of the corners. Most often it will be the rear-right, or front-left of the machine. In some cases, it might be the center of the work area. If your machine does this, skip ahead to [Center Origin Machines](#) below.

After it stops moving, type

```
G0 X10 Y10
```

then hit enter. If your machine moves 10mm into the work area on both axis that's good - it means your machine uses positive workspace coordinates. You simply set the origin in LightBurn to match the machine origin discovered above. If your machine bumped the rails, it uses negative coordinates.

#### Negative Coordinate Machines

If your machine uses negative coordinate space, we need to offset the origin.

LightBurn wants positive workspace numbers, like this:

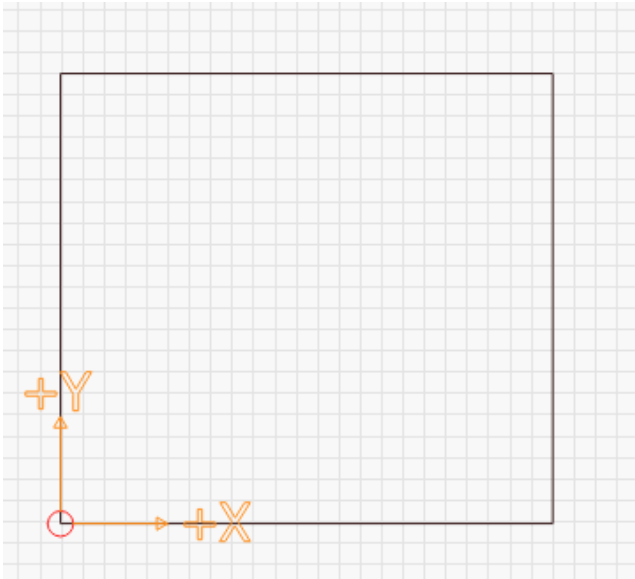

This image shows the origin at the front-left, with positive X values moving to the right, and positive Y values heading to the rear of the machine.

A negative workspace system looks like this:

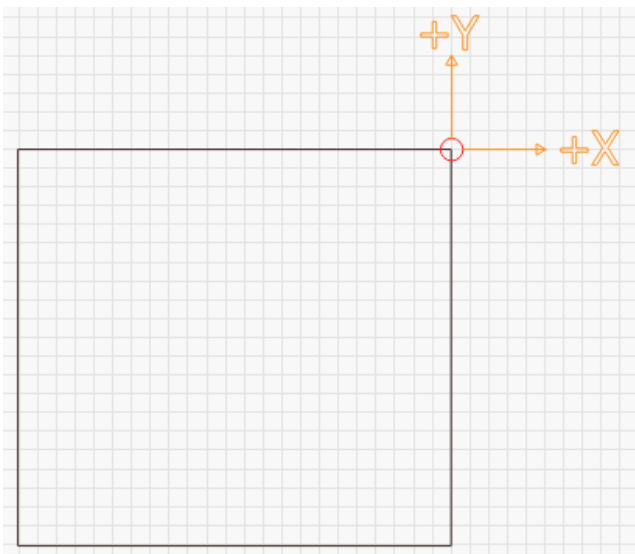

In this image, the origin is at the rear-right of the machine. The X and Y directions are the same as before, but now, to move into the work area, you would need to use negative numbers. Instead, we're going to set up a work offset.

You'll need to know the total distance your machine can travel in both axis. For a Shapeoko XXL, for example, it's 812mm in X and Y. For a 500x500 X-Carve, it's 250mm in X and Y. By applying a workspace offset that is the size of your machine area, we can shift the offset to the opposite corner, like this:

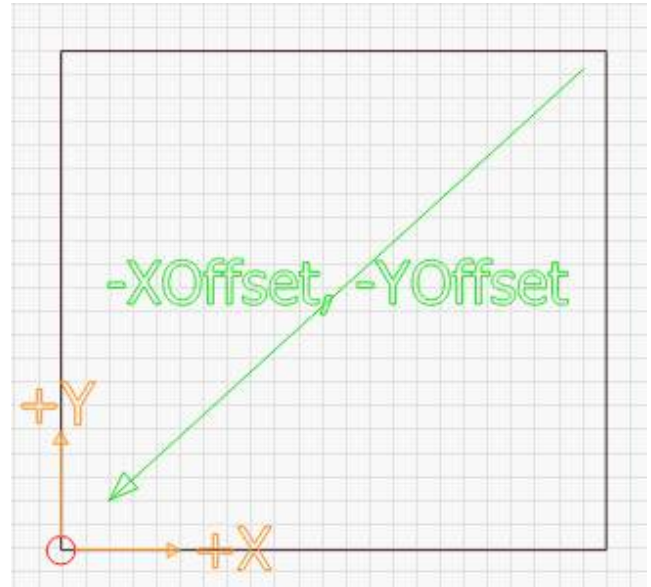

Enter the following command:

```
G10 L2 P1 X-250 Y-250
```

in the console, and hit enter. Note that the '250' above should be replaced with the total travel width and height of your machine. If your machine had a 600mm width and 400mm height, you would use:

```
G10 L2 P1 X-600 Y-400
```

This command offsets the origin by the given amounts. If the origin used to be in the rear-right of the machine, and you offset it in the negative direction by the width and height of the work area, you've moved the origin to the front-left.

If you enable a workspace offset, you will also need to make GRBL report its location relative to this shifted origin, instead of in "machine space" by setting  $\$10=0$ . Some systems, like Easel or Carbide Motion, may need a different value, so it is good to remember the existing setting.

#### Center Origin Machines

Some systems have their origin in the center of the workspace. After homing your machine, enter this command in the console and hit enter:

```
G0 X0 Y0
```

That command says "rapid move to coordinate 0,0"

If your machine travels to the center of the workspace instead of the rear-right you will still need to move the origin just like in the "Negative Coordinate Machines" above, but only by half the size of your workspace. Follow the directions for a negative coordinate space machine, but divide your

workspace numbers in half before issuing the GCode offset command.

#### Machines without homing sensors / limit switches

If your machine does not have homing switches (also called limit switches) you will need to home it manually if you want to use Absolute Coords or User Origin modes. You can do this in a couple ways:

- With the machine off, manually move the laser head to the origin position (usually front-left), then power up the machine. Until you tell it otherwise, the power-on location of the controller is treated as the zero position.
- With the machine powered, jog the laser head to the origin position. In the console window, type: `G92 X0 Y0` and press (enter). The `G92` command tells GRBL to set the current location as the specified coordinate, so you're telling the machine "this is zero". You will also need to set `$10=0` for this to work correctly.

#### XTOOL WI-FI UPLOAD

As of LightBurn 1.2.02, we do not support uploading GCode to the XTool family of lasers via Wi-Fi. The upload mechanism is significantly different than that of the currently supported methods, and that development hasn't yet been completed. Thank you for understanding.

## Primary Docs Ruida

### 4.4.2 Configuring a Ruida

When purchasing a laser with a DSP controller installed, the factory making the machine configures the laser controller for you to tell the controller how fast and in what directions to move, where the homing switches are, and so on.

If you are installing a new controller into a machine, you will need to perform the configuration that is normally done for you by the factory.

A somewhat common mistake for new users is doing a 'factory reset' of their controller - this resets it to the stock configuration supplied by Ruida, not the configuration applied by the company that set up your laser, so it's not recommended to do this. Chances are you already have, which is why you're here.

#### Ruida Machine Settings in LightBurn

With the laser connected to your computer, go to the bottom of the Edit menu and click Machine Settings. LightBurn will open the Machine Settings window and read the configuration from your controller. You should see this screen:

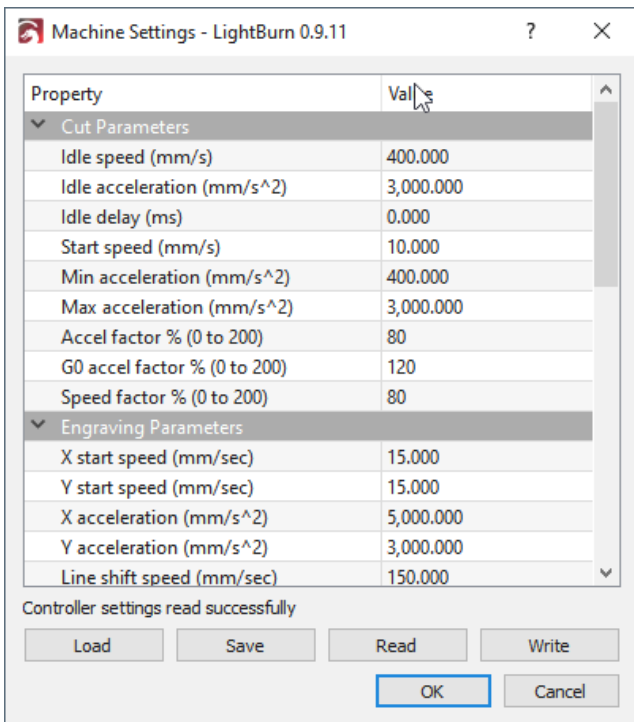

The top section of the list is referred to as user settings - these are settings that are intended to be tunable by the user if necessary. The lower section, under 'Vendor Settings' are things usually configured for you by the factory and should only be changed if you have a good reason for doing so.

It's also a good idea to back up the initial settings before you change them, so you can go back to what you had if you make a mistake and can't remember what you did.

The 'Read' button tells LightBurn to read the settings from the controller (this happens automatically when you open the Machine Settings window). The 'Save' button will write all settings to a file. 'Load' will read settings from a file back into memory. 'Write' commits the settings in LightBurn back to your controller.

In the bottom of the Machine Settings window is a heading called Vendor Settings. Click it to 'unroll it' and you'll see something like this:

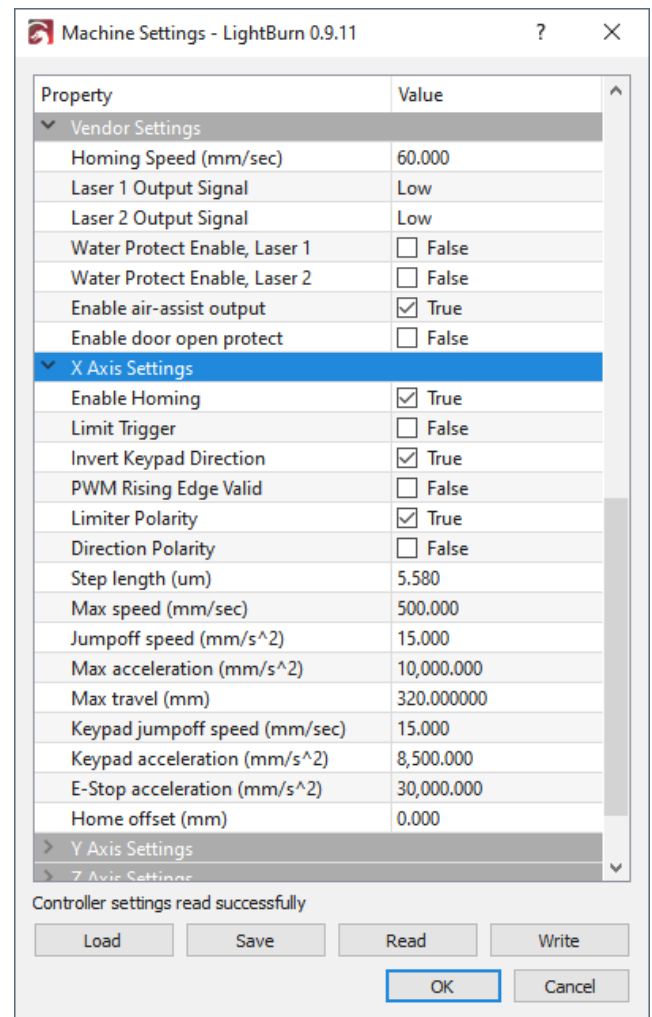

The first section is general configuration, and then there are settings that are specific to each axis, followed by a Laser section, for configuration specific to the laser type.

#### Homing, Directions, and Travel

A DSP laser will have homing switches - one on each axis. They might be physical lever-type micro switches, optical beam-break switches, or inductive proximity sensors. Locate the switch at the end of the X axis, and the one for the Y

axis. Note that the Ruida homes using the X- and Y- limit switches.

When you power up the laser, the first thing it will do is move toward the corner it thinks those switches are at to home itself. If it's moving in in the wrong direction, you'll have to hit the ESC button on the controller itself to stop it.

Bring up Machine Settings in LightBurn, and go to the Vendor settings section at the bottom, and open the X axis and Y axis Settings. Near the top of each will be three check boxes:

- Invert Keypad Direction
- Limiter Polarity
- Direction Polarity

The first (keypad direction) controls which way the arrow buttons move the laser. The second (limiter polarity) tells the controller whether the limit switch triggers high (normally open) or low (normally closed) when contacted, and the 3rd (direction polarity) controls which way the motor moves in general.

There are only 4 possible combinations of "limiter polarity" and "direction polarity" for each axis. I can't tell you which is the correct combination, but change those settings for the X axis until it moves properly when you power the machine, then do the Y axis. Once these are set, the next steps are easier.

When the limiter and direction settings are correct, check that the keypad arrows on the machine are moving the laser in the correct direction. If not, toggle the 'Invert Keypad Direction' button for whichever axis is wrong.

You will also need to set the 'Max Travel' value for the X and Y axis - these numbers dictate the length of each axis, and together define the size of the work area of the machine.

### Step Length Calibration

The next part is figuring out how far the laser moves when you tell it to, and how far off it is. The controller needs to know how far a single step moves when it sends a step pulse to the motors so it can translate real measurements into the proper number of steps.

#### Rough Calibration

In LightBurn, set the 'Start From' setting in the Laser window to Absolute Coords, like this:

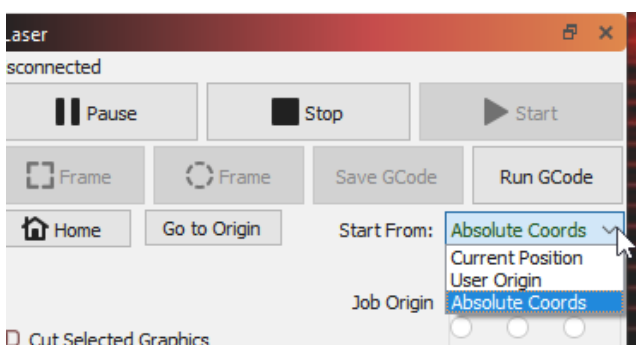

Then draw a small rectangle at the origin. Start with 10 x 10 or 20 x 20 mm, like this:

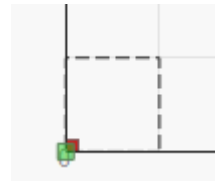

Note that your origin corner might be in a different spot than mine - you should set it in the device settings to match the origin corner of the machine.

Now, use the 'Frame' button (shown above, near the 'Start From' setting) and see how big it frames. If it's barely moving, your step size is too big (the controller thinks it is moving more than it is). If it moves way too far, the step size is too small (the controller thinks it has to take lots more steps than necessary).

This part is just doing rough adjustment - it's not accurate at all, but you need to get into the right ballpark before doing the next part.

In the Machine Settings again, in the settings for the X and Y axis, are values called 'Step Length' Adjust those according to what I said above - If the controller doesn't move enough by half, cut the step length in half. If it moves twice as far as it should, double the step length. Frame again, and iterate until the size of what you've drawn and the size the laser frames is reasonably close.

#### Final Calibration

Now, draw a box similar to the original, but make it 100 x 100, or 200 x 200 (mm), set the Min and Max power low to start, but high enough to make a mark, and run the job it on a piece of scrap material. Measure the result as accurately as you can.

This time, actually do the real math with the step size:

- $\text{New Step Size} = (\text{Current Step Size} * \text{Measured Length}) / \text{Requested Length}$

If the controller complains about 'water protect', you can disable the water protect setting in the machine settings. Ditto for the door protect (it's the lid open switch). If you have a flow meter, you should have it hooked up so you know you have water running through the tube, and have the water protect enabled.

As you are dialing in the above settings, if the steppers skip or make buzzing sounds, you might need to reduce the Idle Acceleration or Idle Speed settings near the top. Those things will require tuning with some trial and error.

#### FIXING SKEWED ENGRAVING

An occasional problem with new setups, and sometimes even existing machines, is lines cutting correctly, but engravings coming out slanted or skewed, like this:



If your output looks like this, you likely have your motor pulse step polarity set incorrectly. On Ruida controllers, there's a setting called 'PWM Rising Edge Valid' that you can change for each axis that tells the controller whether the rising edge or falling edge of a step pulse is what the motor driver is looking for. Toggling this may fix skewed engraving.

The fix is relatively simple. In Edit > Machine Settings, look in the X & Y axis motor settings section at the bottom, and look for the value of 'PWM Rising Edge Valid' on the X axis. Change that - if it's checked, un-check it, or vice versa. Then, copy the new setting over to the Y axis as well.

### What is this setting and why does it matter?

A step pulse is a transition from low to high, or high to low. The controller will hold the line low, and pulse it high, or hold the line high, and pulse it low. The transition itself is what matters, and motor drivers will either look for a transition from low to high (rising edge) or high to low (falling edge) to accept as a 'Step'.

If the laser controller believes that the motor driver is looking for the leading edge signal (when it transitions from low to high), it will pulse the line, and could change the direction line immediately after that. If the motor driver is waiting for the falling edge, it will see the direction change BEFORE the falling edge of the pulse, meaning that it will change direction one step too soon.

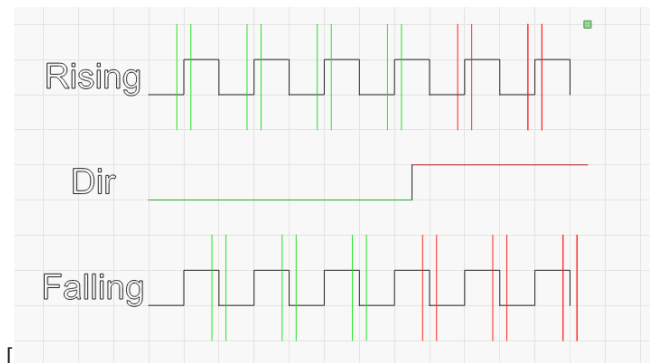

In the image above, the upper line of steps is interpreted as 4 steps in one direction, then two in the other. The lower line is interpreted as 3 and 3, and the only difference is which side of the step signal the driver is looking for.

### Start & End Delay

This feature adds in a start/stop delay to allow the laser to enable any systems it enables itself when starting a job. This gives, for example, fans time to get to speed or evacuate the air in the laser before stopping when done.

## 4.5 User Interface & Features

### 4.5.1 Menus

The various features in LightBurn are accessed through the menus. The various features in each menu are listed and explained here.

- [File Menu](#)
- [Edit Menu](#)
- [Tools Menu](#)
- [Arrange Menu](#)
- [Laser Tools Menu](#)
- [Window Menu](#)
- [Language Menu](#)
- [Help Menu](#)

---

#### FILE MENU

##### New

Clicking "New" in the File Menu will clear any current project and create a new one. You can also press **Ctrl + N** / **Cmd + N**.

##### Recent Projects

This will open a list of the most recently opened files to choose from.

##### Open

To open an existing or saved file, click on "Open" in the File menu or press **Ctrl + O** / **Cmd + O**.

##### Import

You can import any supported LightBurn files into the file you are currently working on. Click on "Import" in the File menu or press **Ctrl + I** / **Cmd + I** LightBurn supports importing the following file types: svg, ai, pdf, dxf, hpgl, plt, png, jpg, bmp, tiff, gif, webp.

##### Show Notes

Add or view project comments through this menu. **Ctrl + Alt + N**

##### Save

To save a project click on "Save" in the File menu or press **Ctrl + S** / **Cmd + S**. Type the name you want the file saved as in the dialog box that opens up.

##### Save As

To save a file with changes, but still keep the original file intact, click on the "Save As" icon in the File menu.

##### Save GCode

Generates and saves the GCode (the code that gets would normally be sent to the laser cutter) for the project as it currently stands. This option will only be enabled for devices that communicate via GCode. **Alt + Shift + L**

##### Export

To export a file to a different file format, click on "Export" in the File menu (**Ctrl + X** / **Cmd + X**). LightBurn can export to SVG, AI, and DXF formats. Bitmaps are only exported in SVG files, and text is automatically converted to simple shapes in all export formats.

If you have objects selected, only those will be exported, otherwise it will export the entire content of your project. If you have exactly one bitmap selected, you will also be given the option to export as PNG or JPG.

##### Print (Black only)

This menu item (**Ctrl + P**) outputs a black and white document to be sent to a printer or built-in "Print to PDF" tools. This document is saved exclusively in black/white.

##### Print (keep color)

Similarly to above, you can use Print (keep color) to send to a physical printer, or to a file, your design for review, markup, etc. The export is sent with the same colors as selected in the [Color Palette]. This can also be triggered by **Ctrl + Shift + P**.

##### Save Processed Bitmap

Exports a copy of a bitmap that you have edited in LightBurn with the edits.

##### Save Background Capture

If you have a camera connected, this function saves a screenshot of the camera feed.

##### Open prefs folder

Opens the folder containing your LightBurn preferences in your file browser.

##### Export Prefs

Allows you to export your preferences as they currently stand.

##### Import Prefs

Allows you to import preferences from an exported copy.

##### Load Prefs Backup

Allows you to import preferences from a list of (automatically saved) versions.

##### Exit



To exit LightBurn, click on the "Exit" in the File menu or press **^ Ctrl** + **Q** / **⌘ Cmd** + **Q**. You will be prompted to save your file if you have unsaved changes.

[Return to top](#)

## EDIT MENU

### Undo

To undo the last editing action done on the current file, click on "Undo" in the Edit menu or press **^ Ctrl** + **Z** / **⌘ Cmd** + **Z**

### Redo

To Redo the last editing action done on the current file, click on "Redo" in the Edit menu or press **⇧ Shift** + **^ Ctrl** + **Z** / **⇧ Shift** + **⌘ Cmd** + **Z**

### Select all

To select all objects in the current file click on "Select all" in the Edit menu or press **^ Ctrl** + **A** / **⌘ Cmd** + **A**.

### Invert Selection

Selects the opposite of what you have currently selected. E.g. if you have one object selected, it will select every object except that one.

### Cut

To one or more objects from the current file, select them and click on "Cut" in the Edit menu or press **^ Ctrl** + **X**. This will put the object on the clipboard, and remove it from the current file.

### Copy

To copy one or more objects, select them and click "Copy" in the Edit menu or press **^ Ctrl** + **C** / **⌘ Cmd** + **C**. This will put the objects on the clipboard, but leave the original object alone.

### Duplicate

To duplicate a selection in place, select one or more objects and click "Duplicate" in the Edit menu or press **Ctrl**+**D**. This is an "in-place" copy and paste operation all in one, bypassing the clipboard. This means if you already have something on the clipboard, it'll still be there after using Duplicate. The duplicate is placed directly on top of the original.

### Paste

To paste an object from the clipboard click "Paste" in the Edit menu or press **Ctrl**+**V**. This will place a copy of the clipboard contents in the current file. Note that LightBurn can paste text or images copied to the clipboard from other software.

### Paste in place

To paste an object from the clipboard click "Paste in place" in the Edit menu or press **Alt**+**V**. This will place a copy of the

clipboard contents in the current file in the same spot that it was in the original file.

### Delete

To delete an object select it and click "Delete" in the Edit menu, or hit **Del**. This will remove the object from the current file.

### Convert to path

This converts a built-in shape object, like a rectangle, ellipse, or text, into lines and curves that can be edited. Click on "Convert to path" in the Edit menu. The original shape information is lost, so you won't be able to change text with the text tool after using this.

### Convert to Bitmap

This converts selected vectors into bitmaps (rasters/pixels).

### Close path

In order to Fill a shape with your laser, the shape must be a closed loop, where the starting and ending point are the same. If the start and end points are very close, but not quite connected, "Close Path" will move them together. Click on "Close path" in the Edit menu or press **Alt**+**C**.

### Close paths with tolerance

Works similarly to close paths, but allows you to set a tolerance for "close" points, so that it doesn't join parts that are far from each other.

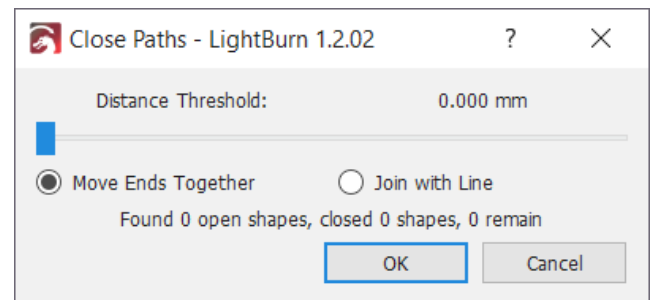

### Auto join selected shapes

Looks at the start and end points of all the selected curves, and if any of them are close enough, connects them together into a single shape. Useful when importing DXF files, which don't contain connectivity information. Click on "Auto join selected shapes" in the Edit menu or press **Alt**+**J**

### Optimize Selected Shapes

Attempts to fit the selected shapes to arcs and lines within a specified error tolerance. Useful for reducing the point count in a shape, or recovering arcs from software that exports them as many small line segments.

### Delete Duplicates

This will delete duplicate items within the drawing, for example if two squares are identical and one on top of the other, this will delete the extra square. This helps to minimize erroneous moves and double-cuts.

### Select Open shapes

This will select all open shapes in the document.

#### Select open shapes set to fill

This will select all the open shapes that are set to fill in the document.

#### Select all shapes in current layer

This will select all the shapes that are set to cut in the current layer of the document. Note that if some of these shapes are grouped, the system may have to un-group them in order to select them.

#### Select contained shapes

Will select all the shapes that fall entirely within the shape you have selected.

#### Image Options

Offers you various ways to refresh or replace bitmap images in your project. Handy if you have made some edits to a bitmap in a different editing software, and you want to replace the old version you have open in LightBurn.

#### Settings

Clicking on "Settings" in the Edit menu will open the **Settings window**, where you can change general user settings and preferences.

#### Device Settings

Opens the **Device Settings** window, for editing LightBurn preferences specific to the chosen laser.

#### Machine Settings

Opens an editor that allows reading and writing firmware settings from supported controllers.

#### Debug drawing

This is mostly an internal tool for LightBurn developers that shows the bounds of shapes being drawn.

#### Convert to cut

Also an internal tool for LightBurn developers - It converts the selected shapes into the cuts that would be sent to the laser, and makes a new shape from the result. This is not how you produce gcode / cuts for your machine, it's just a debugging tool for the LightBurn developers.

[Return to top](#)

---

### TOOLS MENU

Many of the tools in this menu are also available as icons in the tool toolbar that by default, is on the left side of the workspace. See **Creation Tools** for more information.

#### Select

Click on "Select" to select objects in the workspace, or to access menus and toolbars.

#### Draw Lines

Click on "Draw Lines" or press **Ctrl + L** to draw straight or curved lines in the workspace. Click + Drag to make curved lines.

#### Rectangle

Click on "Rectangle" or press **Ctrl + R** to draw rectangles in the workspace.

#### Ellipse

Click on "Ellipse" or press **Ctrl + E** to draw ellipses in the workspace.

#### Polygon

Create a regular polygon with a variable number of sides (triangle, hexagon, octagon, etc). (**Shift** & drag)

#### Edit Nodes

Click on "Edit Nodes" or press **++ctrl+~++** to edit nodes of objects in the workspace.

#### Edit Text

Click on "Edit Text" or press **Ctrl + T** to create or edit text in the workspace.

#### Position Laser

Allows you to click on a place in your project, and have your laser move to that point in real life (works best with absolute coordinates/end-stops).

#### Measure

Opens up a window that provides you with various information about objects as you hover over them in your scene. Things like line length, start and end point, etc.

#### Create QR Code

Allows you to create a QR code containing various information such as: Wifi details, contact info, links, text, raw content, etc.

#### Offset Shapes

Used to create new shapes that are offset from the current selection, inward or outward.

#### Weld Shapes

Fuses multiple shapes together into a single outline.

#### Boolean Union

Adds two closed paths together into one mass so that all their intersecting lines disappear.

#### Boolean Difference

Select an closed path you want cut, and then also select another that you want to cut out of the first and then click Boolean Difference to do so.

#### Boolean Intersection

Select two closed paths and click Boolean Intersection to remove all the areas that don't overlap.

### Boolean Assistant

Gives you a preview of the Boolean functions described above, to help you choose the correct one.

### Cut Shapes

Select the shape you want cut and also select another shape, then select Cut Shape. The outcome will both what you would get from a boolean difference and a boolean intersection. This also works on open paths (unlike the boolean operations).

### Adjust Image

Allows you to edit a bitmap image in various ways, such as brightness, contrast, image processing mode, negative, etc.

### Trace Image

Opens a dialog box where you can trace the content of a bitmap image into vector graphics. ([Read more here](#))

### Apply Path to Text

If you select a shape and a line of text, this command will attach the text to the shape, so the text follows the path. ([Read more here](#))

### Apply Mask to Image

Select a closed shape and a bitmap, and this function will cut the bitmap to fit the shape.

[Return to top](#)

## ARRANGE MENU

### Group

Click on "Group" or press "Ctrl + G" to group the selected objects in the workspace.

### Ungroup

Click on "Ungroup" or press "Ctrl + U" to ungroup the selected objects in the workspace.

### Auto-Group

Automatically groups shapes within other shapes that contain them.

### Flip Horizontal

Click on "Flip Horizontal" or press "Ctrl + Shift + H" to flip the selected objects in the workspace horizontally.

### Flip Vertical

Click on "Flip Vertical" or press "Ctrl + Shift + V" to flip the selected objects in the workspace vertically.

### Mirror Across Line

Select objects and the shift select line to mirror them about, and then click "Mirror Across line" or press "Alt+M".

### Rotate 90° Clockwise

Select objects and click "Rotate 90° Clockwise" or press "."..

### Rotate 90° Counter-Clockwise

Select objects and click "Rotate 90° Counter-Clockwise" or press ".,".

### Two-Point Rotate / Scale

Select object and click "Two-Rotate / Scale " or press "Ctrl/ CMD + 2". Click the point you will rotate about, then to only rotate, move the mouse to the second point. To scale hold shift while rotating. For more information see [Two-Point Rotate / Scale](#)

### Align Centers

Click on "Align Centers" to place the center points of the selected objects directly on top of each other.

### Align Left

Click on "Align Left" or press "Ctrl + Shift + Left arrow" to align the selected objects in the workspace to the left.

### Align Right

Click on "Align Right" or press "Ctrl + Shift + Right arrow" to align the selected objects in the workspace to the right.

### Align Top

Click on "Align Top" or press "Ctrl + Shift + Up arrow" to align the selected objects in the workspace to the top.

### Align Bottom

Click on "Align Bottom" or press "Ctrl + Shift + Down arrow" to align the selected objects in the workspace to the bottom.

### Align H-Center

Click on "Align H-Center" to align the selected objects in the workspace to the center of the horizontal plane.

### Align V-Center

Click on "Align V-Center" to align the selected objects in the workspace to the center of the vertical plane.

### Distribute

Provides various methods of evenly spacing objects across various axes.

### Move H-together

Click on "H-together to move shapes like distribute, but keeps shapes together

### Move V-together

Click on "V-together to move shapes like distribute, but keeps shapes together

### Nest Selected

Exports selected objects to a file, copies that file path, and opens SVGnest.com so you can upload the file and nest your objects.

### Dock

A little like simple nesting. Select some shapes and click one of the directional docking buttons, and LightBurn will "dock" all your shapes together in that direction, moving them together until they touch. See [Docking](#) for more information.

#### Move Selected Objects

Offers various places to move the selected objects to, such as page centre, laser position, upper left, etc.

#### Move to Page Center

Click on this to move selected objects to center of page

#### Move to Upper Left

Click on this to move selected objects to Upper Left of page.

#### Move to Upper Right

Click on this to move selected objects to Upper Right of page.

#### Move to Lower Left

Click on this to move selected objects to Lower Left of page.

#### Move to Lower Right

Click on this to move selected objects to Lower Right of page.

#### Move Laser to Selection

Offers various ways for you to move the laser to parts of the object you have selected, like the top left or centre of it.

#### Grid / Array

Click on "Grid / Array" to create an array or grid of objects in the workspace. A window will open allowing you to enter the parameters for the array or grid. For more details, see [here](#).

#### Circular Array

Click on "Circular Array" to create an array or grid of objects in a circle in the workspace. A window will open allowing you to enter the parameters for the array. For more details, see [here](#).

#### Copy Along Path

Click on "Copy along Path" to create a set of copies of your selected shapes along a path. The path is the last object you select, and the shapes will be copied relative to the first point in the path object.

#### Create Rubber-Band outline from selection

Creates an outline on the current layer encompassing all selected parts.

#### Break apart

Click on "Break apart" to break selected object into individual parts.

#### Push forward in draw order

Click on "Push forward in draw order" or use "Page up" key to move the selected object up one level in the draw order. Usefull when trying to see objects on the screen.

#### Push backward in draw order

Click on "Push backward in draw order" or use "Page down" key to move the selected object down one level in the draw order. Usefull when trying to see objects on the screen. "Ctrl-PgDn" or "Ctrl-PgUp" will send an object to the very bottom, or very top of the objects on the screen.

#### Push to Front

Moves the selected object to the top of the drawer order.

#### Push to Back

Moves the selected object to the bottom of the drawer order.

**Note:** Drawing order changes *only* work in wireframe (outline) rendering mode, not filled. In filled rendering mode, the display order will always match the layer order.

#### Lock Selected Shapes

Locks selected shapes from being edited in any way.

#### Unlock Selected Shapes

Unlocks selected shapes to allow them to be edited again.

[Return to top](#)

### LASER TOOLS MENU

The Laser Tools menu is the new home for utilities that interact with the laser.

#### Print and Cut

This sub-menu lets you run the [Print and Cut](#) wizard, set the targets, enable the different Print and Cut modes, or reset it.

#### Calibrate Camera Lens

Open the camera lens calibration wizard. For more information on setting up the camera, see [here](#).

#### Calibrate Camera Alignment

Open the camera alignment calibration wizard. For more information on setting up the camera, see [here](#).

#### Rotary Setup

This will open the [rotary setup dialog](#) box. Use this to set up your rotary attachment.

#### Feeder Setup

This will open the auto-feed setup dialog. Use this to set up the auto-feed table controls for Ruida controllers with an auto-feeding table.

#### Focus Test

Opens the Focus Test generator tool. Requires a machine with a controlled Z-axis.

### Interval Test

Opens the Interval Test generator tool, though this has been largely replaced by the Material Test generator below.

### Material Test

Opens the Material Test generator tool, which lets you generate and run test grids with varying settings.

### Center Finder

Opens the Center Finder tool, used to locate the center of a circular object in a few simple steps. see [Center Finder](#)

## WINDOW MENU

### Reset to Default Layout

To arrange the windows and menus back to the original default layout, click on "Reset to Default Layout" You can use the Window menu to toggle windows and menus on or off.

### Preview

Click on "Preview" or press "Alt + P" to open the preview window. It will show the current laser project and includes information on cut distance, rapid moves, and total time estimate. Cut lines are in black and traversal moves are red. You can toggle the display of traversal moves on or off, as well as shading by power level.

### Zoom to Page

Zooms so that the full workspace is in view.

### Zoom In

Click on "Zoom In" or press "Ctrl + =" to zoom in the workspace.

### Zoom Out

Click on "Zoom In" or press "Ctrl + -" to zoom out in the workspace.

### Frame Selection

Zoom the view to completely contain the current selection. (Ctrl + Shift + A)

### View Style

Allows you to change the appearance of objects in your scene from wireframe or filled modes.

[Return to top](#)

## LANGUAGE MENU

Choose the language you would like to have LightBurn use in this menu.

[Return to top](#)

## HELP MENU

### About LightBurn

Shows your LightBurn Version, copyright and attribution information.

### LightBurn Support Forum

Links to our online forum where you can get help from our support staff and the community.

### Quick Help and Notes

Click on "Quick Help and Notes" or press F1 to access hotkey list, general usage notes and version information.

### Online Documentation

Click on "Online Documentation" to access the documentation for LightBurn.

### PDF Documentation

Links to a PDS copy of our documentation, if you prefer reading pages over online text.

### Online Video Tutorials

Click on "Online Video Tutorials" to access the tutorial videos.

### CorelDraw macro setup help

Links to documentation about installing the LightBurn macro for CorelDraw

### Generate Support Data

Generates encoded data that is handy to provide to our support staff when you are seeking help with a problem.

### Camera Selection Help

Helps you select an appropriate camera for your laser cutter.

### Check for Updates

Click on "Check for Updates" to make sure you are on the most recent version.

### License Management

Launch the [license dialog](#), where you can enter your license key, or see the status of your trial period or license.

### Enable Debug Log

This is for the developers, turn on the log by clicking on "Enable Debug Log". The log file will be written to your "My Documents" folder on Windows, or Documents on Mac, and is cumulative - each time you enable the debug log it will append to any existing log, so it's a good idea to delete it after you're finished.

[Return to top](#)

- **Device Settings** (settings specific to each laser)

## 4.5.2 Windows & Buttons

### LightBurn Windows

This is a list of all the standard windows (and toolbars) available in LightBurn, and how to use them.

#### USER INTERFACE

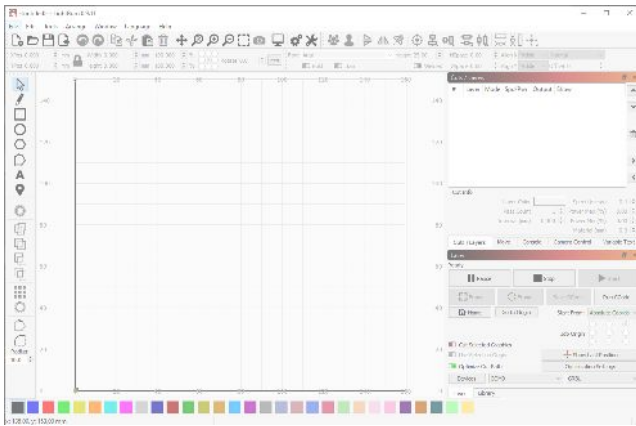

#### Main Elements

- **Main window**, menus, and status bar
- **Main Toolbar** (file, clipboard, view, settings)
- **Move window** (jogging and positioning)
- **Laser Control** (status and control)

#### Editing

- **Arrangement Toolbar** (grouping, mirroring, alignment, distribution)
- **Zooming, Panning, and Selecting Items** (traversing the workspace)
- **Creation tools** (selection, shapes, text, node editing)
- **Modifier tools** (offsetting, Boolean operations, grids)
- **Numeric Edits** (size, position, units)
- **Fonts and Text** (choice, configuration)
- **Variable Text** (dynamic text content)
- **Shape Properties** (configuration, power, cut order)

#### Cut Settings

- **Cuts & Layers** (how the laser treats your graphics)
- **Color palette**

#### Libraries

- **Art Library** (store assets that get reused)
- **Material Library** (store materials that get reused)

#### Machine Specific

- **File List** (files on DSP controllers)
- **Console** (textual control interface for GRBL/GCode)
- **Camera Control** (adjust and calibrate cameras)

#### Setup

- **LightBurn Settings** (global LightBurn settings)
- **Machine Settings** (on-machine settings)

## Main Toolbar



Primary Docs UI GRBL Ruida

## Move Window

The Move window is used primarily for jogging and positioning, as well as homing functions.



This window will not show up for Galvo devices. Their mirror configuration means "static movement in the workspace" doesn't behave as expected.

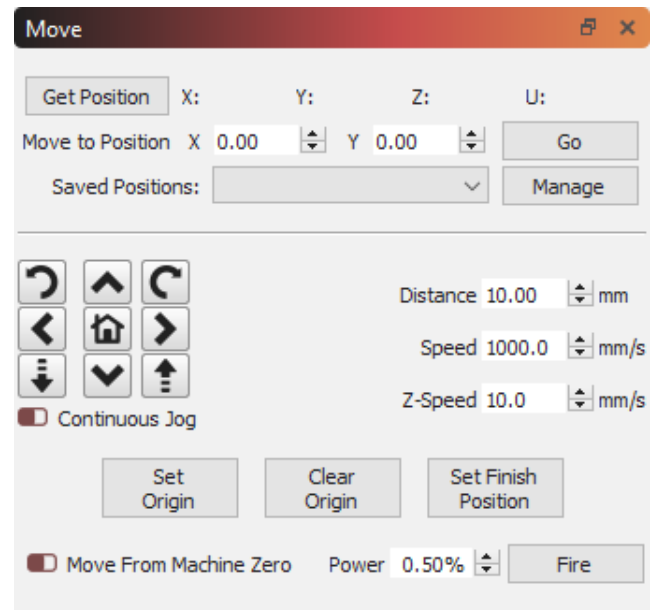

**Get Position**, when pressed, will query the controller for its current location, and display it in the X,Y,Z,U fields to the right.

The **Go** button on the right side will send the laser to the entered coordinates in the *Move to Position* entry boxes.

The **Saved Positions** drop-down displays a list of previously stored positions. This can be useful for jogging to known locations on the work area, like a specific corner, the location of your rotary tool, commonly used jigs, and so on. You can manage the contents of this list by clicking the **Manage** button on the right.

To jog your laser, click one of the arrow buttons around the home button. This will move your head by the set *distance*, and *speed* entered in the window.

The **Speed** setting in this window also controls the movement speed used when use the **Frame buttons**, or using the **'Click to Move'** tool.

If your laser supports it, enabling the **'Continuous Jog'** switch changes the behavior - In this mode, press and hold one of the buttons to move the laser at the desired speed, then release the button to stop.

You can also get the current position, set or clear a custom origin or set the 'Finish Position' - IE, where the laser head is sent when a job finishes.

**Note:** If you have a Ruida controller, you will not see Set Origin, Clear Origin, or Set Finish Position, as these are handled by the controller itself. LightBurn will generally show only controls you can use.

## Primary Docs UI

### Laser Window

The Laser Window lets you select the laser you're using, see it's connection status, send jobs to the laser, and control a few different things about how jobs are run on the laser, including how the job is positioned, and the order things are cut.

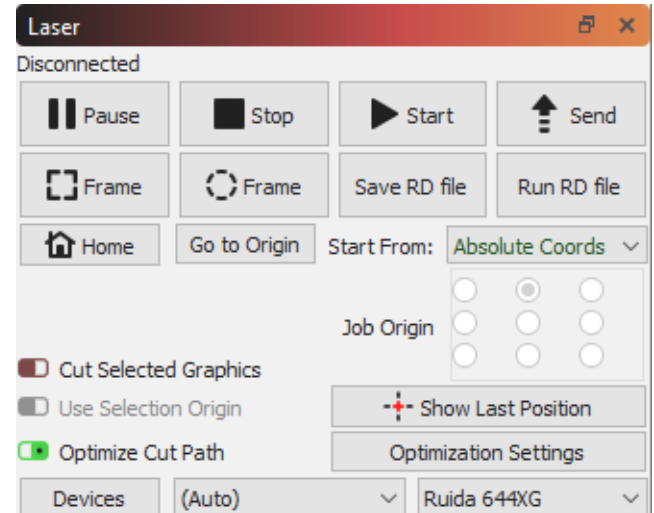

The type of laser you have active will affect how this window looks, and Beginner Mode will change it too, so don't panic if yours looks different than what is shown here.

#### START / STOP / PAUSE

The Start, Stop, and Pause buttons will likely get a lot of use:

- **Start:** run the current file on the laser
- **Pause:** pause a running job, allowing it to be resumed when you click the pause button again
- **Stop:** immediately abort the running job

The **Send** button, if your laser supports it, will let you send the current job to the laser as a named file, so you can run from the laser itself.

#### FRAMING

The two **Frame** buttons are used to preview the position of the job on the laser.



The first is a standard rectangular frame, also called a 'Bounding Box'. This is the smallest rectangle that will fully contain the shapes you're sending to the laser.

If my current file was these four hexagons, the green rectangle around them is the path the rectangular frame would follow:



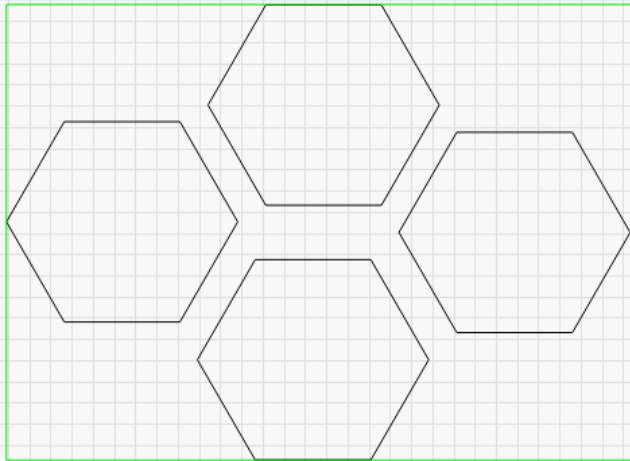

The **O-Frame** button, called the 'Rubber Band Frame', traces a path around your design that is the shape of a rubber band stretched around it. For the hexagons file, it would look like this:

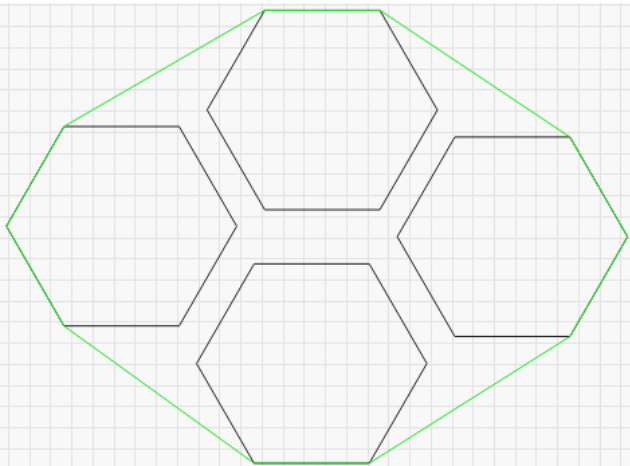

This is useful for lining up jobs with irregular shapes where a simple box outline doesn't fit well. For example, a long, thin diagonal shape, or a triangle.

#### SAVE / RUN MACHINE FILES

The next two buttons will change depending on the type of laser you're using, but they always do the same things. The first will save the current design as a 'Machine Ready' file, in the file format used by your laser. The second will load and run a previously saved file. If you have a Ruida, these will save and run RD files. If you have a GCode based laser, these buttons will save and run GCode files.

#### HOME

The **Home** button will tell your laser to execute a homing cycle, where it moves toward the home position looking for the switches that activate when it hits the boundary. Homing is how your laser figures out where it is.

#### GO TO ORIGIN

The **Go to Origin** button tells the laser to jog to the position currently set as the user origin. Most DSP controllers have an 'Origin' button on the panel that you press to set the current

position as the user origin. If you want to send the laser to that spot, press the 'Go to Origin' button.

#### START FROM / JOB ORIGIN

These two controls affect where the job is placed on the bed of your laser. Please read the [Coordinates and Job Origin](#) page for details on the different modes, and how they affect the placement of your job.

#### CUT SELECTED GRAPHICS

This toggle switch tells LightBurn to only send the portion of your design that is currently selected. If you run a file on your machine and part of the design doesn't cut all the way through, select that piece, enable this switch, and click **Start** to re-send just the selected part of the job. The placement of the part will not change.

#### USE SELECTION ORIGIN

When used in combination with **Cut Selected Graphics**, the **Use Selection Origin** button tells LightBurn that you want the origin of the job to be calculated from only the parts that are selected, not the whole design. This is useful if you have many different shapes in a file, like a large selection of frames, but only want to send the one you've chosen, and want the origin calculated from just that selected item.

#### SHOW LAST POSITION

When enabled, the Show Last Position button places a cross-hair cursor in the edit window at the location of the laser head. If you jog the laser within LightBurn using any of the positioning tools, the position will be updated. The position *does not update live* - for example, it will not update while a job is running, because that would encourage you to watch the screen instead of your laser. A laser should never be left unattended while running.

#### OPTIMIZE CUT PATH

This toggle will enable / disable the path optimizer that plans the cutting path the laser will take. With it disabled, the order will simply be the order that the shapes in your file were drawn in.

#### OPTIMIZATION SETTINGS

This button opens the [Optimization Settings](#) window, allowing you to change the various options that control the cut planner.

#### DEVICES

Opens the [Devices Window](#), allowing you to add, remove, or edit device profiles for the lasers you want to use with LightBurn. Right-clicking the Devices button closes and re-opens the connection to the currently selected device.

## Preview Window

The preview window allows you to preview the path the laser will take and verify your order of operations while getting a rough idea of your final result, while giving an estimated time of how long the program will take.

The previewed path is handled exactly like it will be sent to the laser control so the path is affected by things like

- Cut settings (multiple passes, tabs, kerf, etc)
- Layer order
- Optimization settings
- Cut Selected Graphics
- Origin

## PATH PREVIEW

There are a few ways you can see how the job will run.

### Time Slider

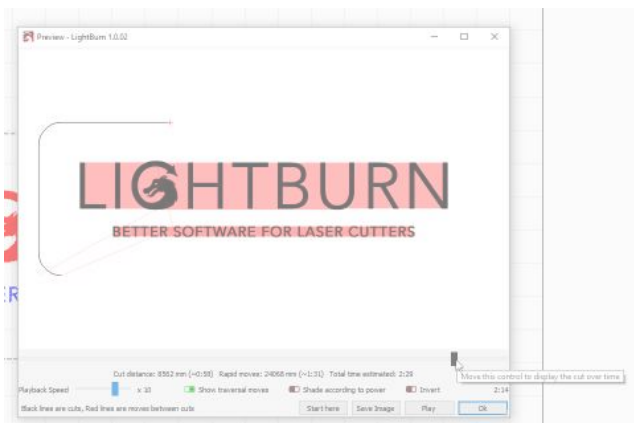

The Time Slider allows you to quickly slide through the project and understand the cut order and path.

### Play Button

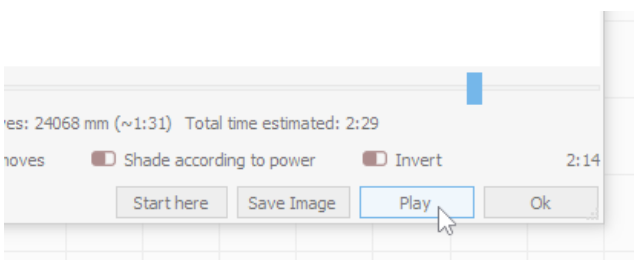

Play allows you to play the project in real time or sped up or slowed down based on the "Playback Speed" slider.

### Job Information

Below the Time Slider there is information about your project:

- Cut distance - The distance the laser travels while on
- Rapid Moves - The traverse move distance (laser not on)
- Total time estimated - This is the total time estimated for the job based on the cut speeds and traversal move speeds defined in "Additional Settings" in **Device Settings**.

Cut distance: 380002 mm (~34:21) Rapid moves: 1307 mm (~0:20) Total time estimated: 34:42

## PREVIEW OUTPUT

### Start Here

The *Start Here* button will allow you to start a program on the laser part way through, from wherever the preview time slider is currently set.

### Save Image

*Save Image* saves out an image file of the current state of the preview window.

## OPTIONS

### Show Traversal Moves

Show traversal moves shows travel (non-laser moves) with red lines when enabled.

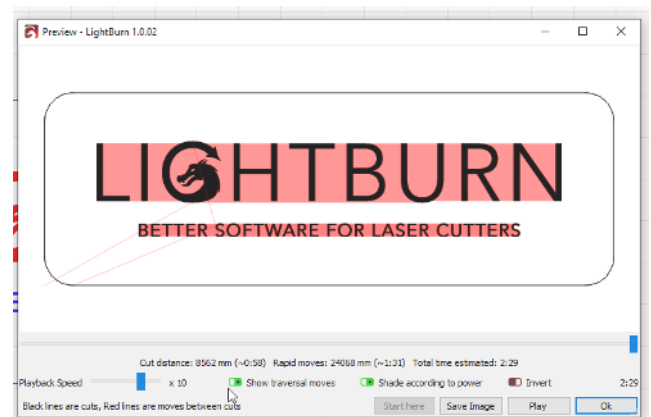

### Shade According to power

The shade according to power option only works with Grayscale with **Image Mode** or Power Scaling with **Fill Mode**

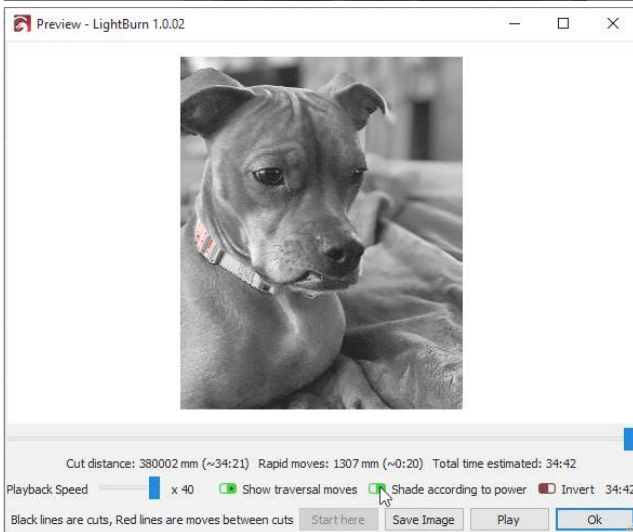
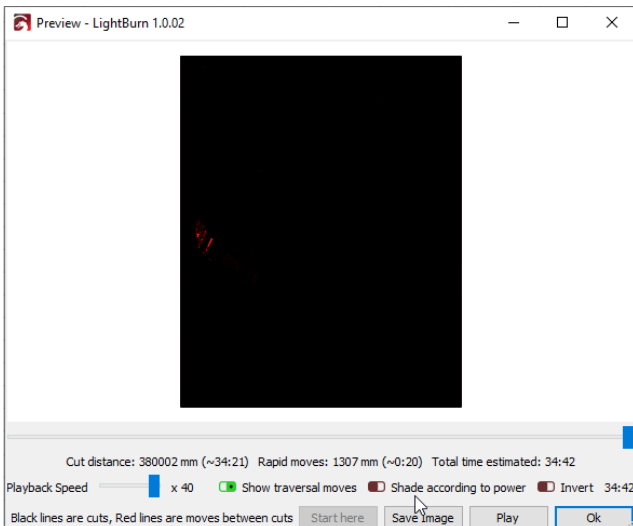

**Invert**

The *Invert* button is used to change the preview to make the lasered areas light, and the background dark, so you can see what your output might look like on slate, wood that's been painted black, or any other material where the burned area will be lighter than the original material.



**Primary Docs UI**

**Arrangement Toolbar**



The Arrangement Toolbar comes in two flavors - long, shown at the top, and shorter, shown just below it. Both offer the same functions, but the shorter version of it is available for those with smaller displays, to save space.

If you are using the shorter version of the Arrangement toolbar, buttons with a small triangular mark in the lower-right corner of the button will pop-up a sub-menu with more choices, like this:

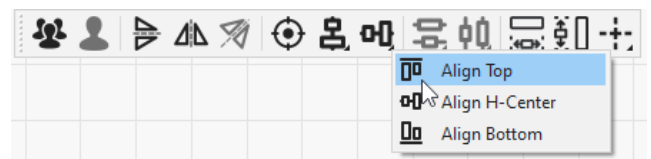

The Arrangement toolbar is mostly functions to control the placement and alignment of shapes in your design.

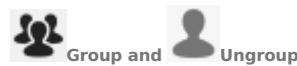

The Group button and the related Ungroup button (below) are used to place shapes into a container (a group) so they can be treated as a single entity when moving, resizing, assigning layer color, and so on. The relative position and size of the grouped objects is maintained. You can also make groups of grouped objects, creating a hierarchy of grouped shapes.

Use the hotkeys  $\text{^} \text{Ctrl} + \text{G}$  /  $\text{^} \text{Cmd} + \text{G}$  to group, and  $\text{^} \text{Ctrl} + \text{U}$  /  $\text{^} \text{Cmd} + \text{U}$  to Ungroup.

Grouping shapes is often used to tell LightBurn to treat the group as a single entity for an operation, like aligning shapes, using the Boolean tools, and even for cutting, if the proper optimization options are chosen, but the most common reason is simply to make it easier to move and size a collection of related shapes, like different parts of an imported file or image trace.

**Note:** grouped shapes are not "connected" - if you draw four distinct lines, and make their ends touch so it looks like a square and then group them, they are still four distinct lines, not a continuous connected path. To join the shapes together, you would use the Auto Join tool.

The Ungroup button does the opposite of what the Group button does - it takes a set of grouped objects, removes them from the group, and discards the container. The individual shapes that made up the group are now distinct shapes again.

 **Vertical Mirror and Horizontal Mirror**

The mirror buttons take the current selection and flip it horizontally or vertically. You can use the hotkeys Ctrl+Shift+H and Ctrl+Shift+V for this, or, if the Edit window has the keyboard focus, just press 'H' or 'V' to flip horizontally or vertically.

 **Mirror Across a Line**

This tool behaves slightly differently to the other two mirror tools in that it creates a copy of the selected object or objects, and mirrors it (or them) across a line. The line must have only two points, and be the last item selected.

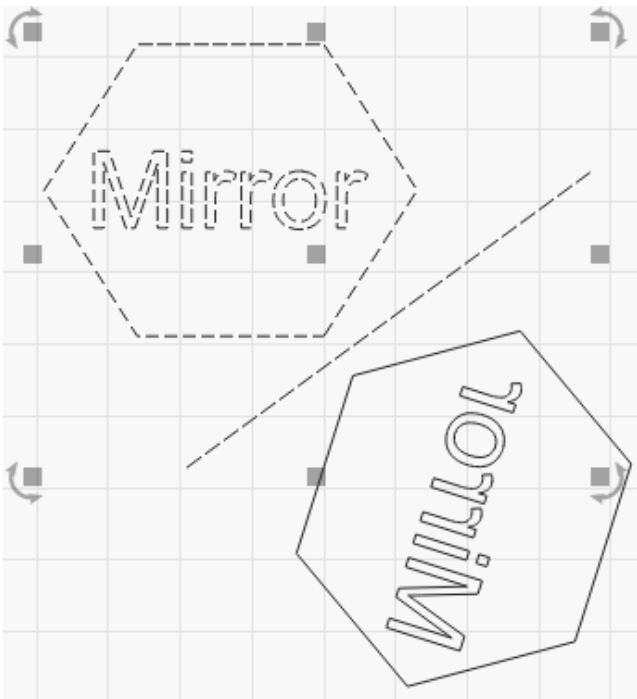

This tool can be used if you want to create a symmetrical shape, like a bottle or heart. You draw half the original shape, then mirror it to create the other half, like this:

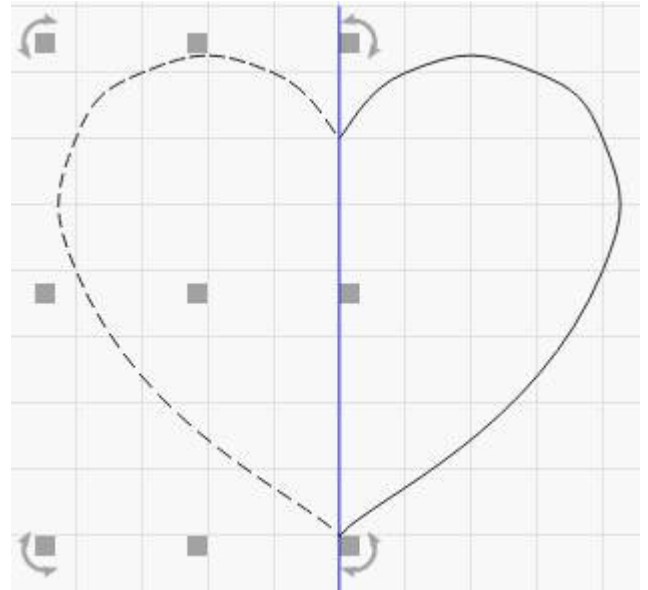

 **Align Centers**

Select two or more shapes, then click the Align Centers tool to move all shapes in the selection to be centered over the last selected item.

 **Align Vertically along left, center, or right**

These buttons will move all shapes in the current selection to align the left, right, or vertical centers of the selected shapes to the last item in the selection.

 **Align Horizontally along top, center, or bottom**

These buttons will move all shapes in the current selection to align the top, bottom, or horizontal centers of the selected shapes to the last item in the selection.

 **Distribute Vertically**

These two buttons will vertically move the items in the current selection to space them evenly, either setting the same distance between the centers of each object, or setting the same distance between edges of the objects.

 **Distribute Horizontally**

These two buttons will horizontally move the items in the current selection to space them evenly, either setting the same distance between the centers of each object, or setting the same distance between edges of the objects.

 **Make Same Width / Make Same Height**

These buttons will set all objects in the selection to the same width or height as the last selected item. Objects will resize from their centers.



These buttons move the current selection to the indicated corner of the workspace, or the center of it. You can quickly move the selection to the page center by hitting 'P' after selecting. These functions can also be found in the Arrange menu, under 'Move Selected Objects'.

Holding the Ctrl key (Command on MacOS) while pressing one of these buttons will move the laser to the indicated corner of the selection, instead of moving the selected objects. These functions can also be found in the Arrange menu, under 'Move Laser to Selection'.



This button will move the current selection to the current position of the laser head. The selection is placed relative to the laser head based on the setting of the 9-dot corner

control on the Numeric Toolbar



## Primary Docs UI

### Numeric Edits Toolbar

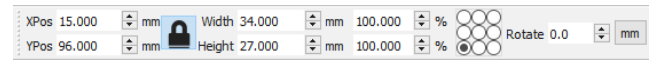

The Numeric Edits toolbar in LightBurn is used for adjusting the size, position, and orientation of shapes or groups of shapes in your project.

#### XPos and YPos

The X and Y (horizontal and vertical) positions of your selection, relative to the point in your selection indicated by the 9-dot control toward the right side of the toolbar. In the above image, the 9-dot control is showing the lower-left corner, so the XPos and YPos values are showing the current location of that corner of the selection.

#### Width and Height

The width and height of the current selection. When the lock control is enabled, the aspect ratio (relationship between width and height) of your selection is maintained - this means that if you have a shape that is currently 50mm wide and 25mm tall, it is twice as wide as it is tall, or it has a 2:1 aspect ratio. If you change the width to 80 while the lock is enabled, the height will automatically change to 40, preserving the 2:1 ratio. If you unlock the lock control, the width and height can be changed independently.

The width and height controls are followed by percentage controls which can be used to quickly change the relative size of your selection. Enter 50 in one of the boxes, and the size will become 50% of whatever it was before.

#### Rotate

The rotate box is used to rotate the current selection by the number of degrees entered.

#### mm / in control

Used to quickly toggle between metric and imperial. Default state will depend on your current unit of measurement.

#### Equation support

Note that the XPos, YPos, Width, Height, and Rotate fields can all accept equations, and the XPos, YPos, Width, and Height controls accept units as well. This means that if you are working in mm, but you want to create a shape that is 5 inches wide, just enter 5in or 5" into the width field and LightBurn will convert it for you. More information about the equation support in LightBurn can be found on the [Tips and Tricks page](#).

## Primary Docs UI Text & Fonts

### Fonts and Text

Creating text in LightBurn is simple - click the Create Text tool (**A**) on the **Creation Toolbar**, click somewhere on the page to get a cursor, and type.

When you enable the Create Text tool, the Text Options toolbar will activate as well.

With the Text tool in LightBurn you can:

- Create text on the screen, or edit existing text by clicking within it.
- Change font and size, alignment, and spacing
- Enable / disable automatic welding
- Create **Variable Text** objects

### FONT SETTINGS

There are a number of global font settings that can be found in the settings dialog on the **File Settings** page

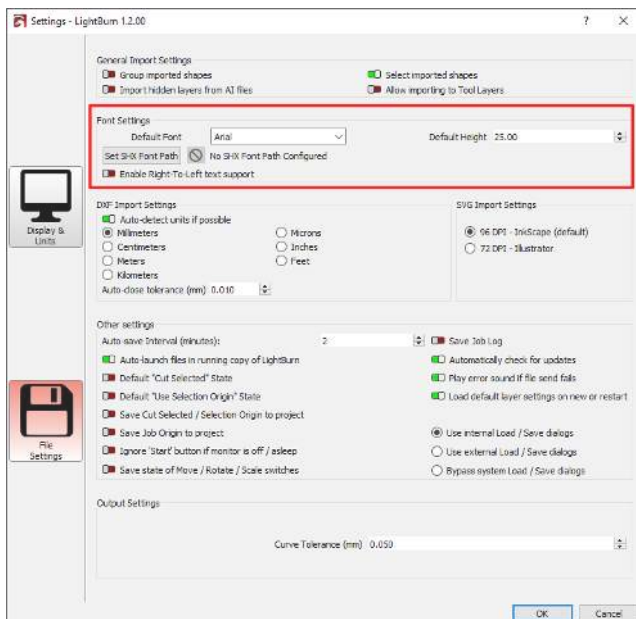

- **Default Font** - Default selected font for new documents
- **Default Height** - Default font height for new documents
- **Enable Right-to-Left text support** - This will automatically be enabled on first run if a Right-to-Left language is the current system input language. But it can be forced on here later if needed. It will allow you to turn on Right-to-Left font rendering for any text.
- **Set SHX Font Path** - Click to set directory containing SHX font files. Shift+Click to clear. See **SHX Fonts** section below for more.

### TEXT OPTIONS TOOLBAR

The Text Toolbar, located on the upper toolbar in LightBurn by default, is where you set properties on text shapes, like which font to use, as well as size, spacing, and more.

The Text Toolbar looks like this:

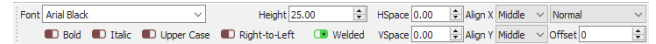

The list of fonts in LightBurn is taken from your computer system. If you want to use a new font in LightBurn, use the facility provided by your operating system to install the font, then re-start LightBurn.

- **Height** - Sets the overall font height. The Height property of fonts is not exact - It is generally the height of a capital letter X in the font, but every font has an internal size that is scaled by this height, and the dimensions aren't required to be accurate.
- **HSpace** - adjusts the horizontal character spacing as a percentage of the font size. Positive numbers space the characters out more, negative numbers move them closer together.
- **VSpace** - adjusts the vertical line spacing as a percentage of the font height. Positive numbers increase the distance between lines, negative numbers reduce it.
- **Align X** - chooses the horizontal anchor position of the text - Left, Right, or Middle
- **Align Y** - chooses the vertical anchor position of the text - Bottom, Top, or Middle. Top aligns text to the top of capital letters, and Middle aligns to roughly the middle of the capital letters. This is most useful when applying text to a path.



- **Bold** - Displays the font in bold typeface, if available
- **Italic** - Displays the font in italics, if available
- **Upper Case** - Forces all text to be upper case
- **Right-to-Left** - Force Right-to-Left text rendering. Must be enabled in settings. This will automatically be set if enabled and current input language is Right-to-Left.
- **Welded** - Enables automatic welding of characters. When characters touch or overlap, as is common with script fonts, enabling this option will automatically weld the overlaps together.

The remaining two options are for Variable Text, like serial numbers, dates, and so on. More information about Variable Text can be found [here](#).

### CURVED TEXT

After creating a piece of text, if you return to Selection mode

by clicking the Select tool  or pressing Esc, you will see a blue dot near the text you've created, like this:

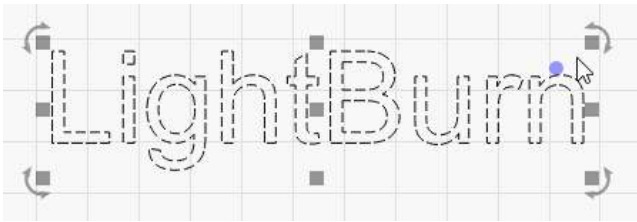

If you hover over the dot, your cursor will change to the bend cursor.

If you click and drag the dot, your text will bend around an invisible circle, like this:



Double click the dot to clear the bend and restore the text.

**TEXT ON A PATH**

If you want the text to follow a more complicated curve, you can use the 'Apply Path to Text' function in LightBurn to attach text to any shape in LightBurn. Draw your shape and your text, then select both and go to Tools > Apply Path to Text, or right-click and choose it from the pop-up menu:

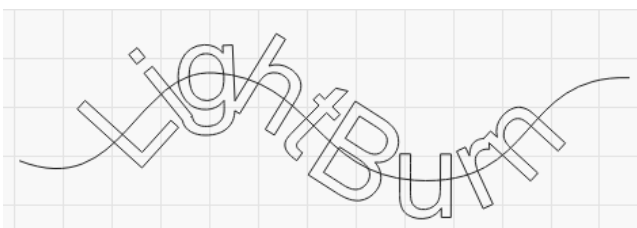
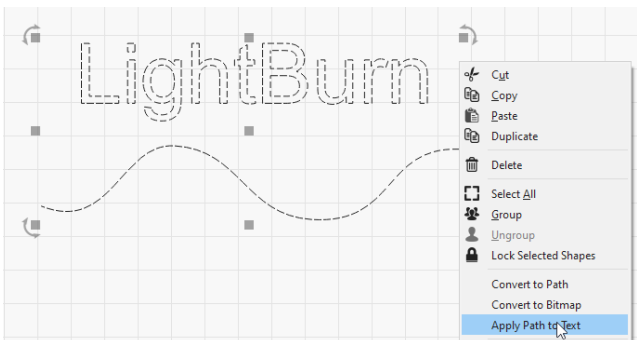

Note that for text to remain editable you cannot delete the path, so if it is not something you want engraved along with your design, put the path on its own layer and set that layer not to output, like this:

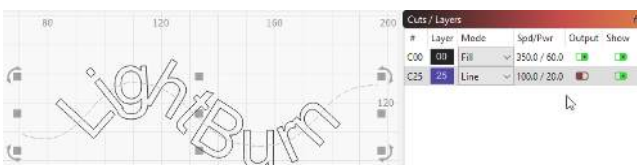

Curved text and text on a path will still automatically weld, and can be used with the **Variable Text** feature as well.

**SHX FONTS**

LightBurn also supports the use of SHX font files which are an old AutoDesk font format, mainly intended for use with CNC machines. Most importantly, SHX fonts lack many of limitations of standard system fonts and have the ability to define "single line" fonts, such as this:

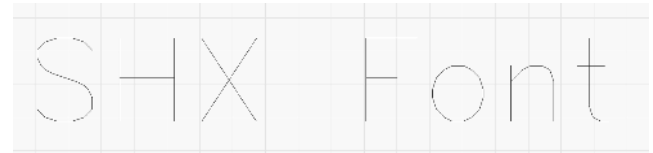

LightBurn does not ship with any included SHX fonts but there are many to be found online for free with a quick search. Once you have SHX files downloaded, LightBurn must be told where they are. In the **Font Settings** dialog, click on "Set SHX Font Path" and choose the directory where your SHX files are located. It will not show the files as it is merely a directory chooser.

Once LightBurn knows where to load the SHX fonts from they should automatically show up in the **Text Options Toolbar** font dropdown.

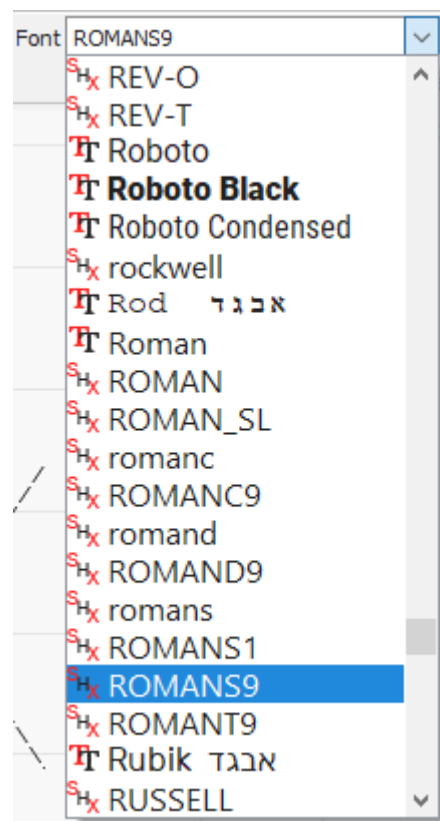

SHX fonts are differentiated from normal fonts by the icon next to each entry:

- **SHX** denotes an SHX font
- **T** denotes a standard operating system font

### MOVING LIGHTBURN FILES WITH FONTS

When you save a copy of a file that contains text, LightBurn automatically includes makes a copy of the text as a path and embeds it into the file. If you open the file on another computer that has the same font, you will be able to edit the text as usual. However, if you open the design on a computer *without* the font, LightBurn will warn you about the missing font(s) and load the path embedded in the file. This way your file won't break when you move to another computer, although you won't be able to edit the text without the correct font.

If you want to move designs containing text between computers, be sure to install all necessary fonts on all computers you're using.

### IMPORTING OTHER FILES WITH TEXT

If you are opening files not made in LightBurn that contain text, please make sure that any fonts used in the file are installed on your computer *or* that the text has been converted to paths using whatever tools are available in the other program. Different programs will use different terms for this process, but terms such as 'welding', 'convert to outlines', and 'convert to path' are commonly used.

## Primary Docs UI

### Shape Properties

In the `Window` menu, you can enable the `Shape Properties` panel, which will contextually display properties of any selected shape. The contents of this panel will depend entirely on the shape or shapes that are currently selected.

At the simplest, such as when only a Path shape, `QR Code` or when multiple shapes are selected, the panel will only display 3 properties:

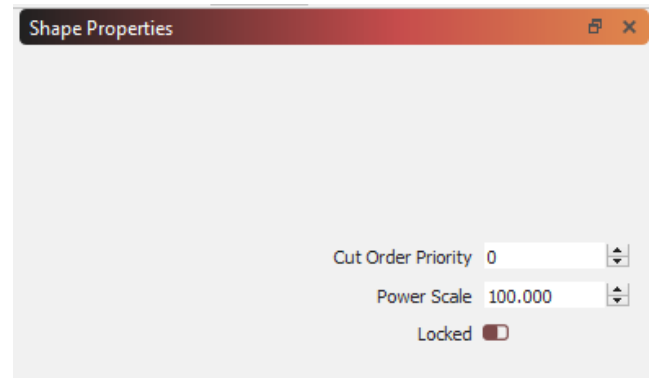

- **Cut Order Priority:** Sets the priority of this shape when used with 'Order by Priority'\nin the Cut Optimization settings. Lower values are cut first.
- **Power Scale:** Scales the power used to cut this shape by this\percentage between Min Power and Max Power
- **Locked:** Prevents movement or other changes to this shape.

Note that locked shapes are shown without the usual selection controls since they cannot be moved while locked:

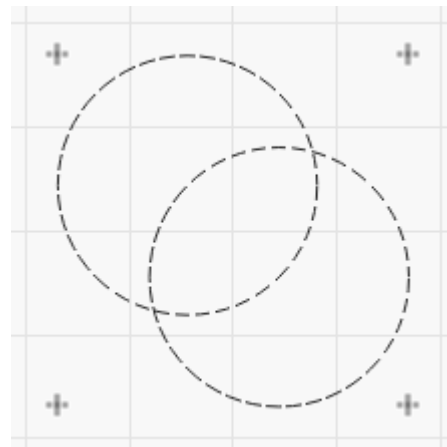

When multiple shapes are selected, changing these values acts on all selected shapes at once.

Other shape types include a wide variety of other properties that can be set but will always also include the properties listed above.



## IMAGE

Cut Order Priority	0
Power Scale	100.000
Locked	<input checked="" type="checkbox"/>
Gamma	1.000
Contrast	0.000
Brightness	0.000
Enhance Radius	0
Enhance Amount	0.000
Enhance denoise	0

- **Gamma:** Adjusts the mid-tone curve for images. 1.0 is normal. Lower values brighten the mid tones, and higher values will darken them.
- **Contrast:** Increases or decreases image contrast.
- **Brightness:** Increases or decreases image brightness.
- **Enhance Radius:** Radius of edge enhancement - 0 is none.
- **Enhance Amount:** Increases or decreases edge enhancement.
- **Enhance denoise:** Use to reduce noise in smooth areas.

**Note:** Enhance is also often referred to as "Unsharp masking", and will increase the contrast of edges in the image. A larger radius spreads the effect across a wider area near the edge being enhanced.

## ELLIPSE

Cut Order Priority	0
Power Scale	100.000
Locked	<input checked="" type="checkbox"/>
Width	307.953
Height	122.697

- **Width:** X axis size component.
- **Height:** Y axis size component.

## POLYGON

Cut Order Priority	0
Power Scale	100.000
Locked	<input checked="" type="checkbox"/>
Width	279.000
Height	250.000
Sides	6

- **Width:** X axis size component.
- **Height:** Y axis size component.
- **Sides:** Number of sides.

## RECTANGLE

Cut Order Priority	0
Power Scale	100.000
Locked	<input checked="" type="checkbox"/>
Width	100.000
Height	100.000
Corner Radius	0.000

- **Width:** X axis size component.
- **Height:** Y axis size component.
- **Corner Radius:** Sets the radius for curved corners on the rectangle.

## TEXT

Cut Order Priority	0
Power Scale	100.000
Locked	<input checked="" type="checkbox"/>
Max Width	0.000

- **Max Width:** Text will begin scaling if the length exceeds this, use zero for no limit..

## Primary Docs UI Tools

## Creation Tools

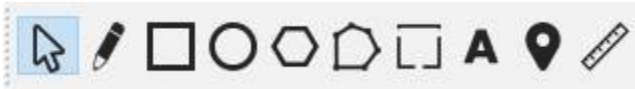

The shape creation tools are the basic ways you build stuff from scratch in LightBurn, along with the Selection tool, and the 'Click to Position' tool.

The tools are:

- Selection Tool
- Draw Lines
- Rectangle
- Ellipse
- Polygon
- Edit Nodes
- Add Tabs
- Create Text
- Click-to-Move
- Measurement Tool



## SELECTION TOOL

You'll likely use this more than any other tool in LightBurn. The selection arrow is used to choose which things in your workspace you want to change, and there are number of different ways that selection happens in LightBurn.

## Click Selection

Point at the outline of a shape and click with the left mouse button to select it. The shape will change from solid to an animated pattern of dashes. There are several things you can tell from this pattern:

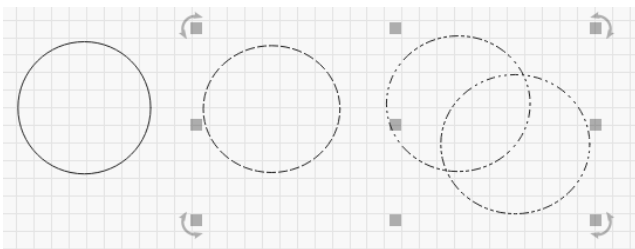

The circle on the left is not selected. The circle in the middle is selected, and it is a simple shape, because the pattern is just simple dashes. The two circles on the right are grouped - visible because the pattern is a combination of dots and dashes.

The selection shown above is also comprised of unlocked shapes, as denoted by the fact that the **move, resize, and rotate controls** are shown. **Locked shapes**, however, do not show any of these selection controls, as shown below.

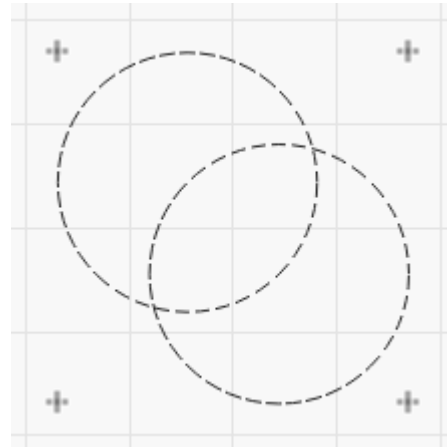

The direction that the pattern animates shows the direction that the shape will be cut in (unless you tell LightBurn that it's ok to choose a different direction).

To clear the current selection, left click an empty space in the view, or press the Esc key.

## Drag Selection

If you click an empty space in the edit window and drag the cursor, a selection rectangle appears. Drag the rectangle out over a number of shapes and let go to select them. There are two types of drag selection:

## Enclosing Selection

If you drag from left to right, you'll see a red rectangle. Selecting a shape with an enclosing selection means the shape must be completely contained by the rectangle in order to select it.

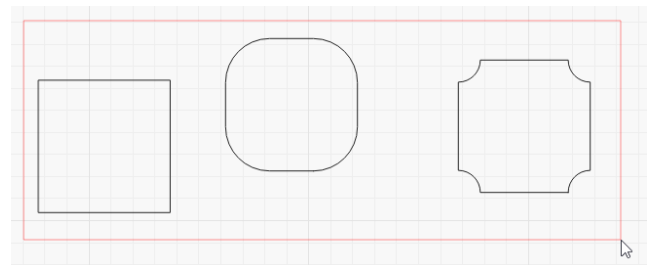

## Crossing Selection

If you drag from right to left, you'll see a green rectangle. Selecting a shape with a crossing selection means that if the rectangle crosses the shape at all, the shape will be selected:

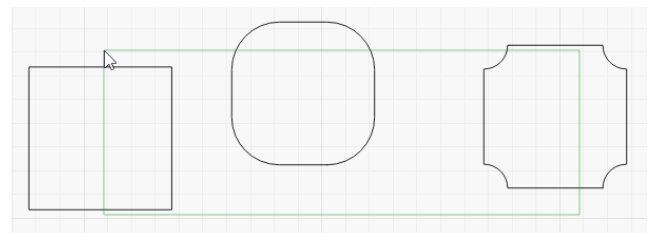

### Selection Modifiers

To supplement click-select and rectangle selection, LightBurn supports these modifier keys:

- **⇧ Shift** : Holding Shift while selecting will add the new selection to the current one
- **⌘ Ctrl + ⇧ Shift** / **⌘ Cmd + ⇧ Shift** : Holding both Ctrl and Shift will remove the new selection from the current one
- **⌘ Ctrl** / **⌘ Cmd** : Holding Ctrl by itself will toggle the selection state of the new selection

(Note that on MacOS, the Command key is used instead of the Ctrl key)

### Moving, Resizing, Shearing, and Rotating

When one or more shapes are selected, several controls appear around them, like this:

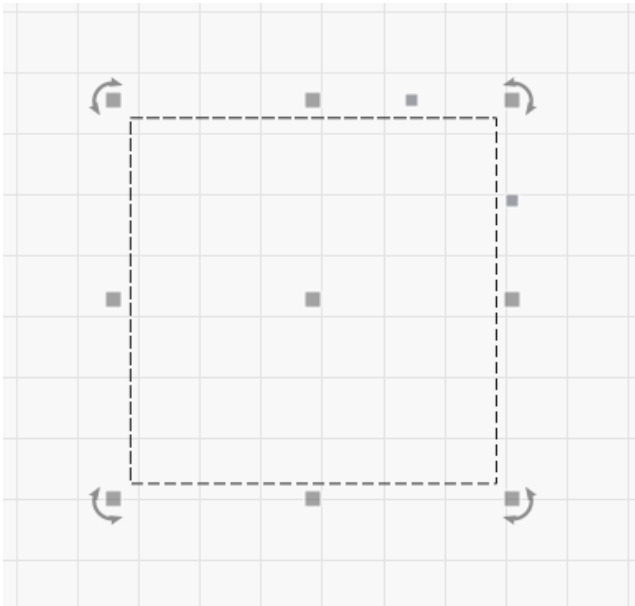

The small squares around the outside of the selection can be clicked and dragged to resize the selection from that side or corner. If you move the mouse over one, the cursor will change to show that the action is available.

When dragging one of the four corners, the shape will maintain its relative width to height (aspect ratio) so it doesn't 'stretch'. You can override that by holding the Shift key while dragging a corner.

When dragging any of the sizing adjustments, the behavior is asymmetric - the other side of the object acts like an anchor and stays in place. Holding the Ctrl key (or Command on MacOS) makes the action symmetrical, using the center of the object as the anchor instead of the other side.

When dragging the non-symmetrical adjustments, you can "shear" the entire design in the X or Y axis. This allows for "corner-pinching" of your design, and maintains the same center as you had before.

The center square that appears is a movement handle - you can click and drag it to reposition the shape, however you can also click anywhere on the boundary of the shape to do

this, and you don't even have to select it first - Simply click the boundary, and while continuing to hold the left button, drag the shape.

The circular arrows shown at the four corners are used to rotate the shape. By default the rotation is "free", however holding the **⌘ Ctrl** key will snap it to 5 degree increments.

When dragging, scaling, or rotating shapes, the bottom status bar in the main window will often show feedback, like this:

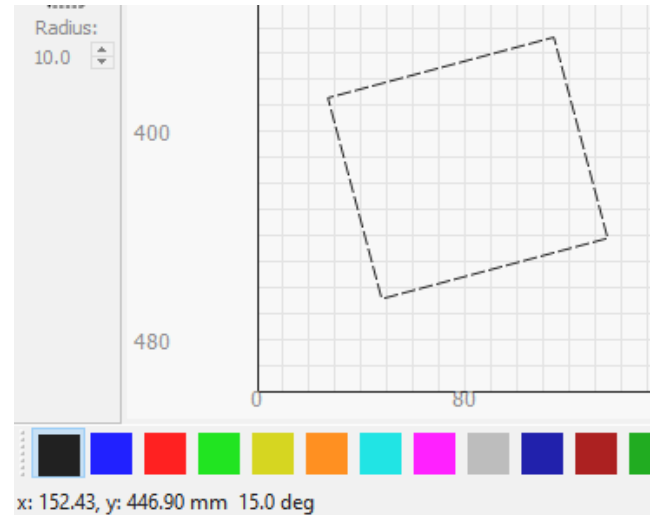

Here I can see the position of my mouse, and the angle I have rotated the shape to while I'm rotating it.

### Snapping

When you move the mouse over a shape to select it, you will occasionally see the cursor change to a small crosshair. This shows that you are over a snap point, like a corner, node, the center of a line, or the center of a shape. If you click at this moment, the point you drag the object from will be that snap point. When dragging an object to move it, as you get near other objects, those objects may also snap the cursor location, allowing you to position shapes perfectly with each other. If you are close to a grid point, the selection will snap to the grid as well.

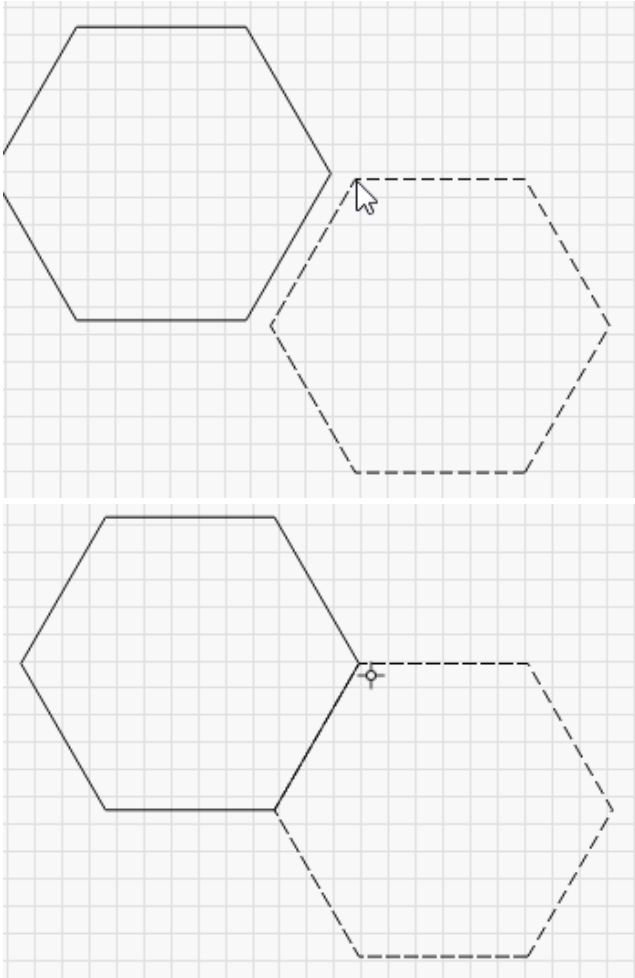

If you do not want shapes to snap when dragging, hold the Ctrl key to temporarily turn off the snapping behavior.

**DRAW LINES TOOL** 

Hotkey = ( ^ Ctrl ) / ( \* Cmd ) ( L )

Click the pencil to use the Line tool. Click anywhere on the page to start a line, then move to a new location and click again to finalize the current line at that point. This will continue until you either click back at the starting point of the shape to close it, or click the right mouse button to stop. You can also press the Esc key to cancel the current line.



**Measuring**

A little known feature of the Line tool is that it is also intended to be used for measuring distances. The status

display at the bottom of the main window shows the length of the line being drawn, even before you've completed it.

If you want to measure the distance between two points in your design, start a line at one point, then move the mouse to the other point, but *don't click yet*. Look at the status window to see the length of the line in progress. When you have noted your measurement, right-click or press Esc to cancel the line.

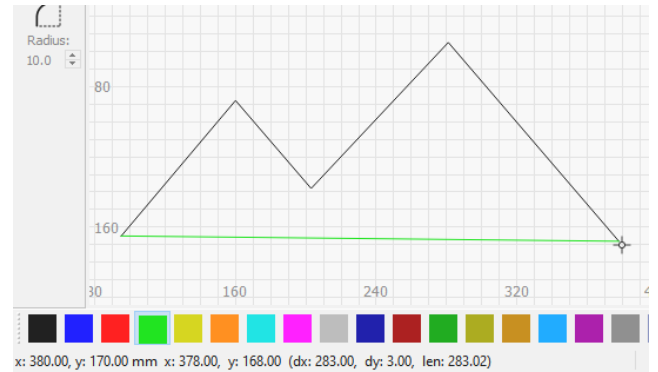

The status window shows:

- dx: the distance along the X axis only
- dy: the distance along the Y axis only
- len: the length of the current line segment
- It will also show the angle between successive line segments as you create them

**RECTANGLE TOOL** 

Hotkey = ( ^ Ctrl ) / ( \* Cmd ) ( R )

The rectangle tool is used to draw squares and rectangles. Holding Shift while dragging will lock the width and height, producing a perfect square. Holding Ctrl will drag the rectangle or square from the center, instead of the corner.

With a rectangle selected, if you look in the **Shape Properties Window** you can adjust the 'Corner Radius' property to produce rounded rectangles, or frames with inward corners:

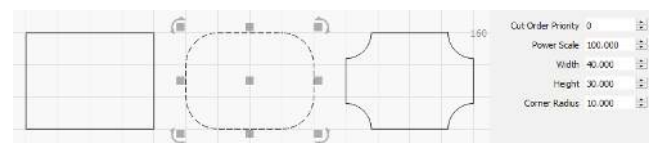

**ELLIPSE TOOL** 

Hotkey = ( ^ Ctrl ) / ( \* Cmd ) ( E )

The ellipse tool is used to draw ellipses and circles. Similar to the Rectangle tool, holding Shift while dragging will lock the width and height, producing a perfect circle. Holding Ctrl will drag the ellipse or circle from the center, instead of the corner.

## POLYGON TOOL

The polygon tool is used to draw regular polygons, like hexagons. Holding Shift while dragging will lock the width and height. Holding Ctrl will drag the polygon from the center, instead of the corner.

With a polygon selected, if you look in the [Shape Properties Window](#) you can adjust the Sides property to change the number of sides the polygon has:

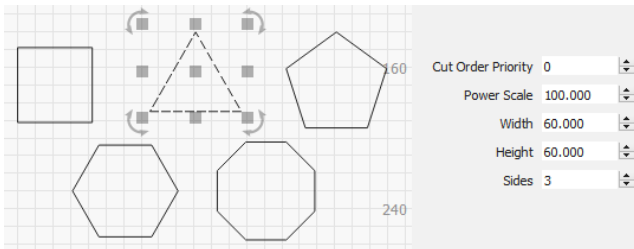

## CLICK TO MOVE TOOL

Hotkey =  + 

The Click-to-Move tool is a quick way to jog your laser to a location somewhere in the workspace. Select this tool, then click anywhere on the page and LightBurn will issue a command to send your laser there. This tool automatically turns itself off after about 10 seconds, in case you accidentally leave it on. Trying to select a shape and having the laser move away from where you want it can be confusing.

## Primary Docs UI

### Cuts / Layers

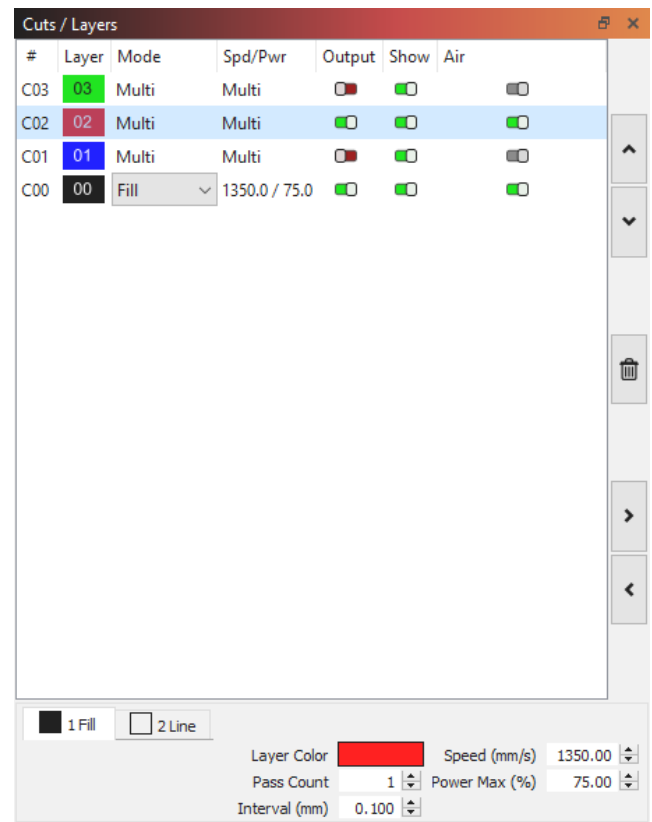

The Cuts / Layers window in LightBurn shows the list of operations you have in your design. The layers will usually be cut in this order, but you can change that if you want.

This view gives:

- A summary of all operations in the design
- The type of operation (Line, Fill, Multi, or Image)
- The main speed and power settings
- Toggles to show whether the layer is output (sent to the laser) or shown in the editor window.

If you select an entry in this list of operations, the values at the bottom of the list will let you edit speed, power, number of passes, and interval.

The buttons to the side allow you to manipulate the list of layers:

#### Move



The first two buttons, "Move up / Move down", let you re-order the entries in the list.

#### Delete



This button will delete all the content on the selected layer.

#### Cache



These two buttons let you copy a layer's settings (right arrow) into a cache and paste the settings onto a selected layer. This can be very useful if you want the same settings on multiple layers, or want to use one layer's settings as the starting point for further modifications on another layer.

#### ADDITIONAL TIPS

- If you right-click the 'Output' or 'Show' headers at the top of the list, you can quickly turn on, off, or toggle that setting for all layers:

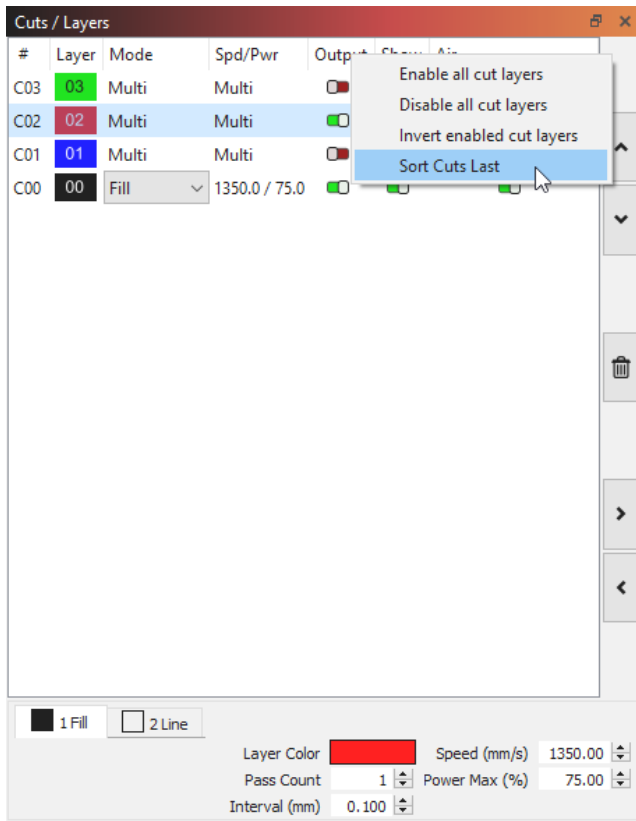

- Right-clicking an entry in the layer list will flash all the shapes using that color in the edit window, allowing you to quickly see what's using this layer setting.
- Holding the Shift key and clicking a layer entry will select all shapes using that layer color. Note that if you have shapes using this layer grouped with other shapes from other layers, the shapes from the selected layer will be removed from the group in order to select them, so this operation *can* alter your file.
- Double-clicking an entry in the layer list will bring up the full **Cut Settings Window**, allowing you to edit to all the cut settings, including many not shown here.

## Cut Settings Editor

### CUT SETTINGS EDITOR

The Cut Settings window in LightBurn is accessed by double-clicking an entry in either the **Cuts / Layers** window or the Material Library list. The window you see may vary from the screenshot, as different laser features, LightBurn modes (Beginner) or updates can change its appearance and settings.

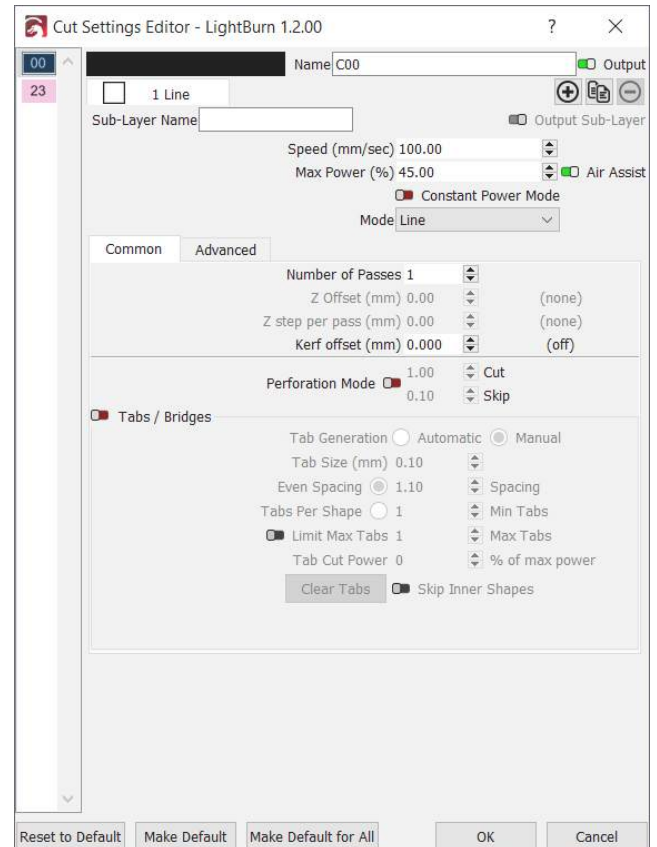

In the Cut Settings Editor (CSE) you can create, edit, adjust, and clone layers and sub-layers for your projects. This gives you finer control when operating your laser. Line mode follows the vector lines in your design, fill mode scans back and forth to remove material from the "inside" of a shape, and offset fill removes material on the "inside" of a shape following a spiraling pattern based on the outside shape. You can create sub-layers to combine these modes, which replaces LightBurn's older "Fill + Line" option while also opening up many more options.

For a comparison of Line (left) versus Fill (right) modes, see below.

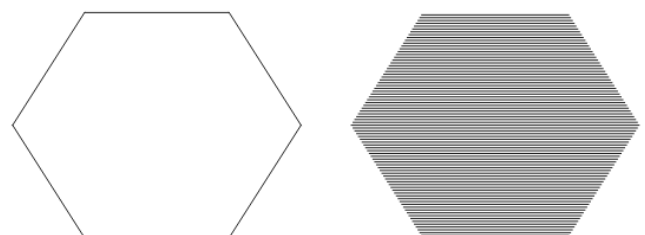

**Operating Modes**

There are four different 'modes' in LightBurn that choose how the laser will render your design:

- **Line mode** - traces along the outlines
- **Fill mode** - fills the design with parallel lines
- **Offset Fill mode** - fills the design with lines that follow the original shape
- **Image mode** - Works similar to fill, but with specific settings for images

In all variations of the Cut Settings Editor, the most basic settings are displayed at the top of the window (speed, power, output toggle, air assist, and mode). The lesser used, more specialized options follow below, and are split into two panes - Common and Advanced.

We'll go through the different settings used in each mode, and explain their use.

**Shared / Basic Settings**

All layers have a few settings that are the same, regardless of the type of layer.

**Speed:** how fast the laser will (ideally) move when tracing your design. Depending on your laser, its firmware settings and limits, and the design, it may or may not actually reach this speed.

The next two require a bit of explanation:

**Max Power:** The power level to run the laser at

**Min Power:** The power value used for corners, or when moving at low speed (*DSP only*)

**Note:** On GCode based systems, you *only* get the "Max Power" option. On DSP systems, you have the additional 'Min Power' setting, which is used when traveling at low speed, or when moving through corners.

If you are cutting at a low overall speed (for example, 10 to 20 mm/sec on a CO<sub>2</sub> machine) the laser might only ever use the 'Min Power' setting, so in that case it is best to use the same value for both. If you are doing 'surface marking' you ideally want Min Power to be just above the firing threshold of the laser, so corners still produce a burn, but without scorching.

**Sub-Layers**

Sub-Layers allow you to set multiple cut/engraving settings on the same layer & geometry. This can enable the use of single-setup etching & cleanup passes for galvo lasers, as well as staggered engraving, cutting, and other operations for more complex jobs regardless of machine type. You may have up to 11 sub-layers per layer.

**Comparison of Sub-Layers vs Single Layer**

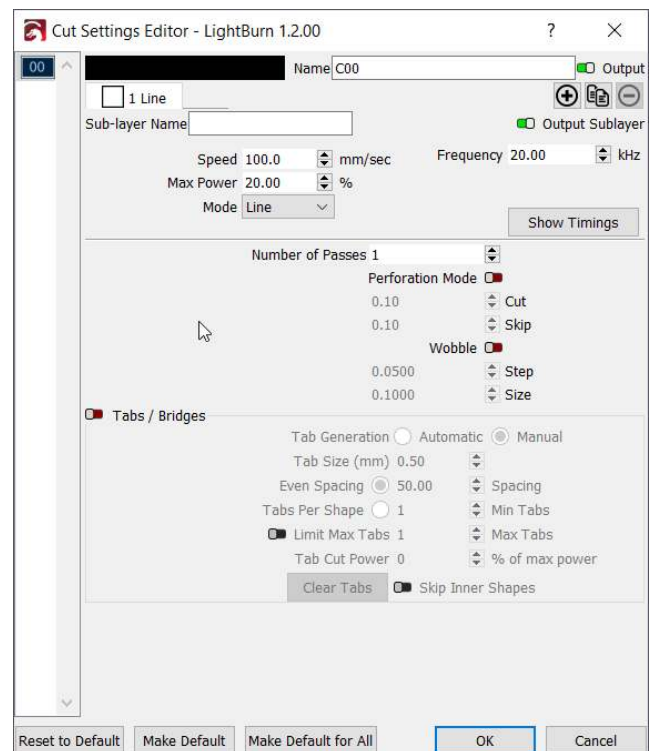
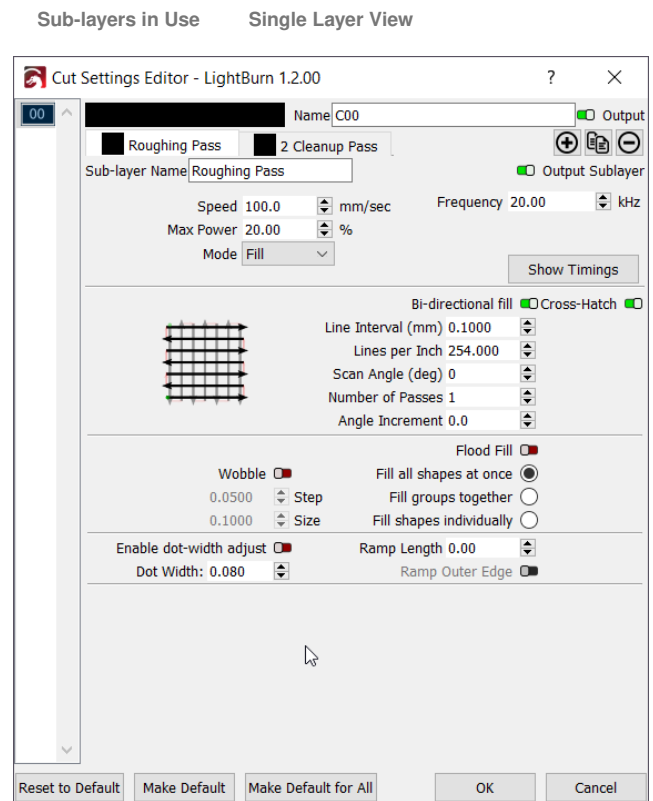

With the Sub-layer feature, you can configure count, type of pass, speed, frequency, and more, without duplicating geometry in your design.

To make a new Sub-layer, you can either click the plus icon or the duplicate icon (two overlapping pages) in the tabs

area of the Cut Settings Editor. The plus sign will create a new sub-layer with default settings, and the duplicate icon will create a copy of the current sub-layer. The minus sign icon on the far right will delete the currently open sub-layer, so long as it's not the only sub-layer.

#### CUT SETTINGS - FILL MODE



#### Main Window Changes (1.2.00+)

When using sub-layers, your Cuts / Layers window will show the mode as "Multi", as seen below. You can quickly reorganize and edit the tabs as you can within the full Cut Settings Editor in the quick settings, at your convenience.

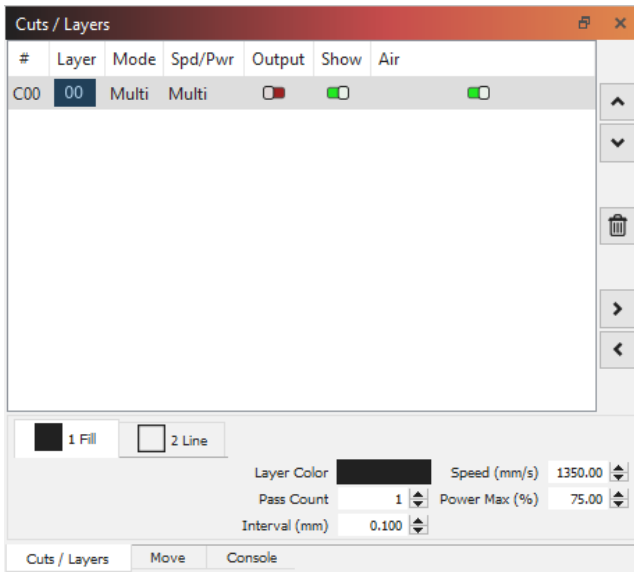

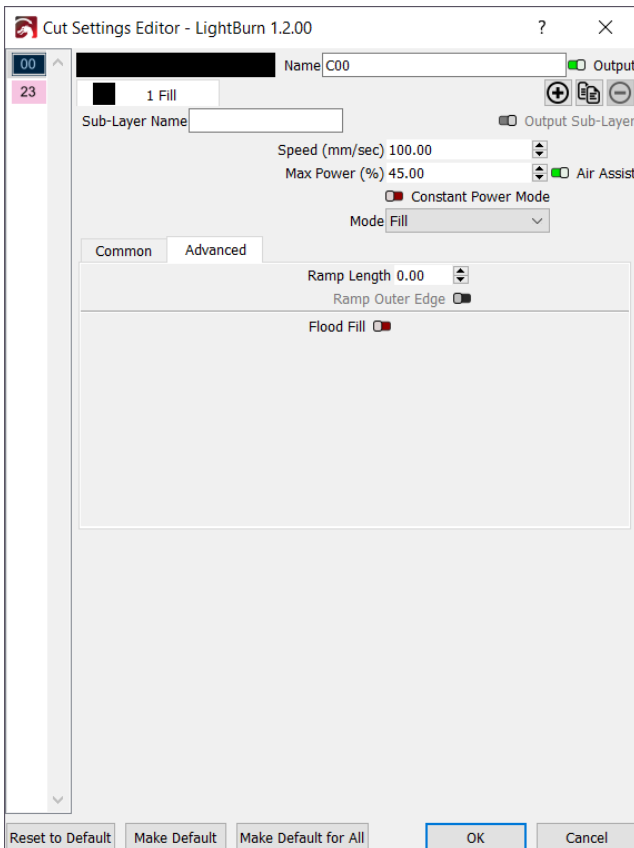
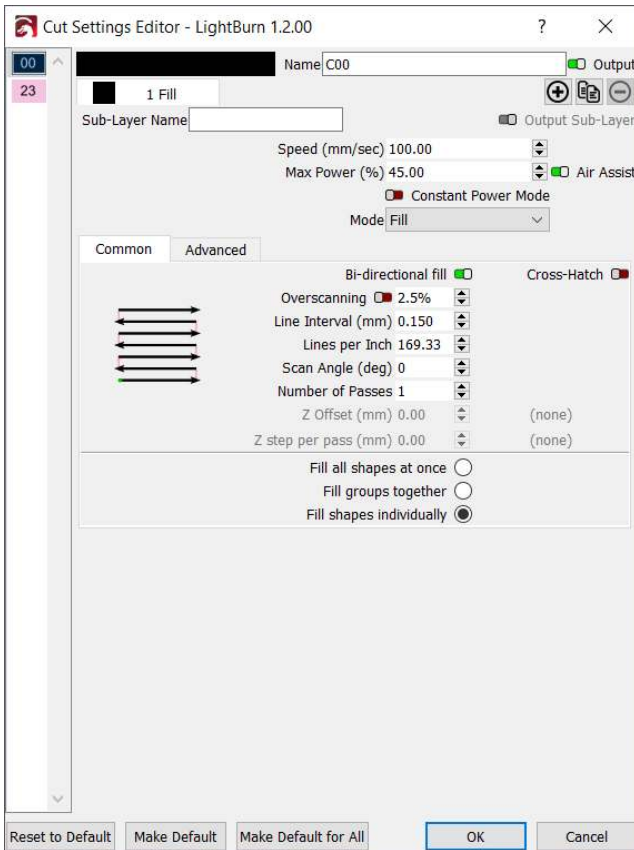

Common Settings    **Advanced Settings****Note for long-term users**

In older versions of LightBurn the 'Fill' mode was referred to as 'Scan'. We've updated the terminology to make it easier for new users.

Fill mode permits you to instruct the laser to scan line by line and fill in the shape you want, similar to how a paper printer works. Fill mode will fill in closed shapes but not open shapes.

**Bi-directional Fill**

When enabled, the laser will engrave in a side-to-side sweeping motion, engraving in one direction and again for the return direction. When disabled, the laser will engrave traveling one way, then return to the start of the next line, not engraving the return pass. Depending on the type of laser, enabling this can save significant time on long engraving jobs.

**Cross-Hatch**

When enabled, runs a second engraving pass 90 degrees rotated from the first to ensure a consistent and thorough fill.

**Overscanning**

When enabled, adds extra moves to the beginning and end of each line to give the laser time to speed up before firing, and slow down afterward.

If your machine has low acceleration or you see darker burns at the sides of your fills, you may need to increase the amount of overscanning. If you do not see this setting, your machine is likely a DSP controller and handles this automatically in hardware.

**Line Interval**

Controls the spacing between scanned rows, and indirectly controls 'Lines per Inch'.

**Lines per Inch**

A different, often more intuitive way of controlling the line interval, or spacing between rows.

**Scan Angle**

Normally 0, meaning the laser will scan back and forth horizontally across the image, progressing from the bottom of the image to the top. If you set this to 180, the laser will scan the image from top to bottom. Setting this to 90 will scan the laser vertically over the image, progressing from left to right.

**NOTE:** If you have a DSP controller, we do not advise using angles that aren't a multiple of 90 degrees. Horizontal and Vertical scanning is supported natively by the hardware, and it will automatically handle over-scanning beyond the sides of the image to get the head to full speed before engraving starts. Scanning at non-90 degree angles is "emulated" using normal cutting moves. It works, but it's mostly useful as a style option, and not recommended for general use.

### Number of Passes

Sets how many times the laser will run this filled shape.

### Angle Increment

This feature allows subsequent passes of the layer or sub-layer to increment the scan angle automatically.

### Z Offset

If you have Z moves enabled, and your controller supports it, the Z Offset setting can be used to move the laser head closer to the material (inward) or farther away from it (outward). Focusing deeper into the material can sometimes help to cut thicker material, and lifting the laser away from the material can produce a thicker line.

### Z step per pass

When doing more than a single pass over a shape, the Z step per pass setting allows you to tell LightBurn to raise or lower the laser with each pass by some amount. This is most often used for thick cutting or deep engraving, allowing you to shift the focus point deeper with each pass to help maintain efficient cutting.

#### Warning for Z moves

If your system uses auto-focus, you may not be able to push the focus point lower, because most systems treat the auto-focus height as the lowest possible height (Z limit) to avoid crashing the laser head. Be careful using Z moves, as they do have the potential to physically damage your laser by crashing the head into the material.

### Fill Grouping

These options control which shapes are filled at the same time on the laser. If you run your laser fast, OR your laser accelerates slowly, it is often most efficient to scan things all at once, so the laser spends most of its time moving at the speed you've chosen, and less time changing direction. If you are engraving slowly, or your laser accelerates fast, or the design contains a lot of blank space, it can be more efficient to fill clusters of close shapes, or just fill the shapes one by one. If you aren't sure, try different options and use the preview to estimate the time.

- **Fill all shapes at once:** The default, this setting means that everything on this layer will be filled at the same time, sweeping back and forth across the whole job. If you are running the laser fast (300 mm/sec or more) this is usually the most efficient option, with some exceptions.
- **Fill groups together:** This setting will fill all shapes in a group at the same time.
- **Fill shapes individually:** This setting fills all shapes one by one.

### Advanced settings

Under the **Advanced** tab you'll find a few useful, but less frequently used options.

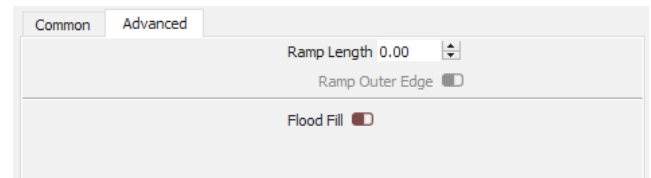

### Ramp Length

This setting can be used to slope the sides of an engraving by varying the laser power, and is useful if you create rubber stamps, particularly if the designs have thin regions that need extra support. The ramp length controls how far from the design the slope will extend.

**Note:** On a DSP controller, the ramp varies the laser power from Min Power to Max Power, so you must set these differently to get a ramped side. Typically you would set Min Power to be just above the firing threshold of your laser.

### Flood Fill

Flood fill tries to eliminate travel moves across blank space, so it's perfect for engraving something like a large, empty rectangle, where the blank area in the middle would consume most of the time spent.

#### Warning

This option is incredibly useful when you need it, but is very sensitive to machine tuning and backlash, and can end up leaving gaps in your engraving if the design is complex and/or your machine is not set up optimally.

If used on complex designs, Flood Fill can produce engraving paths that jump around a lot, and return later to fill in missed spots, which is why it can leave gaps if the machine isn't well tuned. Use it sparingly, and use the Preview tool to see how the option will engrave your design so you aren't surprised by the path it takes.

### Fill + Line Behavior

In older versions of LightBurn, Fill+Line mode allowed primitive Sublayer use to draw an outline around an engraved shape. This has since been superseded. The legacy behavior can be approximated with **Sub-Layers**, one for Fill and a second one for Line with the same base motion settings.

#### Danger

LightBurn will automatically convert pre-1.2 project files with Fill+Line settings to Sub-Layers in 1.2, including Fill+Line behavior. This produces two layers, one with your legacy "Fill" settings, and a subsequent layer with "Line" settings, to be run afterwards. Going backwards from current project files to pre-1.2 LightBurn is likely to result in breakages involving Sub-Layers due to how complex the changes are.

CUT SETTINGS - LINE MODE

Common Settings    **Advanced Settings**

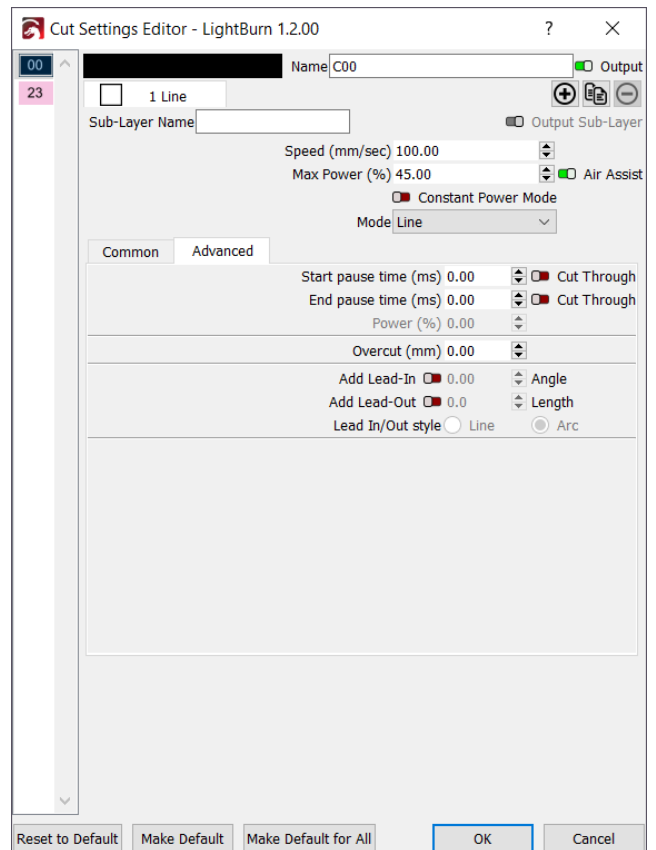
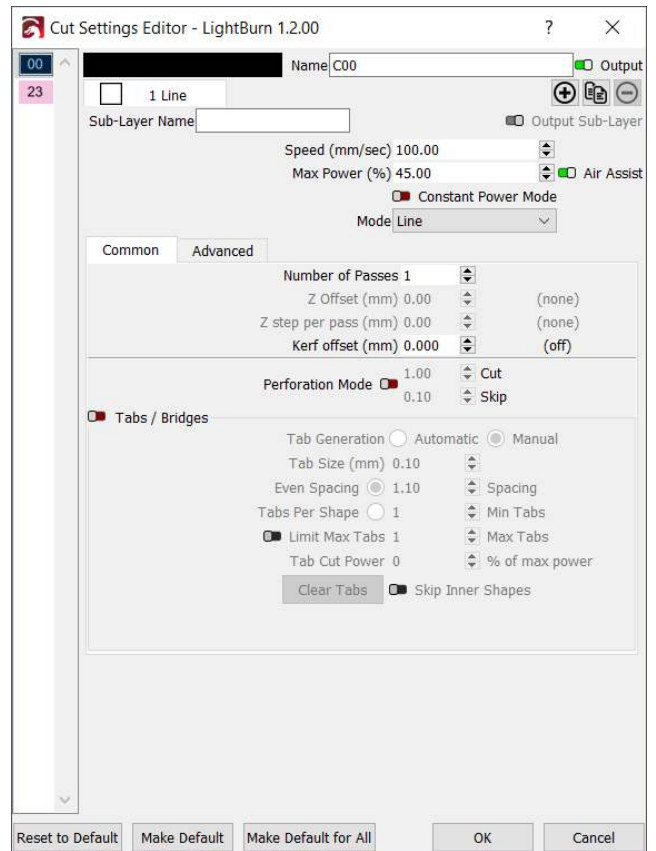

### Note for long-term users

In older versions of LightBurn the 'Line' mode was referred to as 'Cut'. We've updated the terminology to make it easier for new users.

The image above shows the settings for 'Line' mode. In this mode, the laser follows the exact path of your design, tracing the lines with the beam enabled at the power you've chosen. If you move quickly, or with low power, you will likely just etch the surface (sometimes called vector marking). If you move slowly and with high power, especially with a CO<sub>2</sub> laser, you will cut deeper, possibly through the material. The only difference between surface marking and cutting is the power and speed.

#### Cut Options

##### Number of Passes

How many times the laser will repeat the shapes on this layer. Sometimes, when cutting thick material, trying to engrave very deep, or using a lower power laser, more than one pass may be necessary.

##### Perforation Mode

The dotted lines below were generated using a different setting, called Perforation Mode. If you are trying to cut fold lines in card stock, stitch holes in leather, or just make dashed lines, perforation mode allows you to choose the distance to cut, followed by the distance to skip.

This can also be very useful when trying to cut delicate material with a powerful laser - Setting very low cut and skip values, like 0.1mm each, toggles the beam on and off very quickly, and gives you an effectively lower power output. Varying the ratio between the two lets you adjust that power - using 0.1mm for both cut and skip would give you the effect of 50% of your chosen output power, because it is spending exactly half of the time with the power on. Using 0.05mm and 0.15mm for cut and skip, respectively, would be 25% of your chosen power, because it is only cutting for 25% of the total distance of the shape.

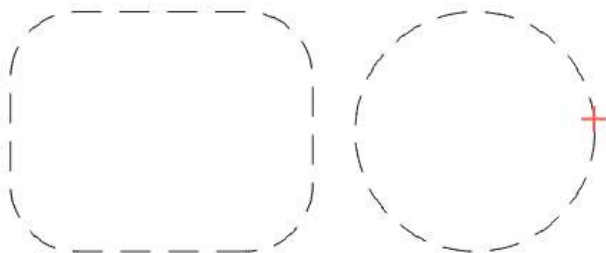

##### Tabs / Bridges

As Tabs / Bridges is a much more complicated feature, you can find an in-depth walk through on the [Tabs / Bridges](#) page.

##### Wobble (Galvo-only)

This option is only available if you are using a galvo laser. Because galvo lasers move so fast, it can be hard to apply

enough power to a given area while in line mode. Wobble can be used to trace small circles along the path of the line, forcing the galvo to spend longer in each section of the line. The 'Step' value refers to how far apart the circles are, and the 'Size' value refers to the diameter of the circles (in millimeters).

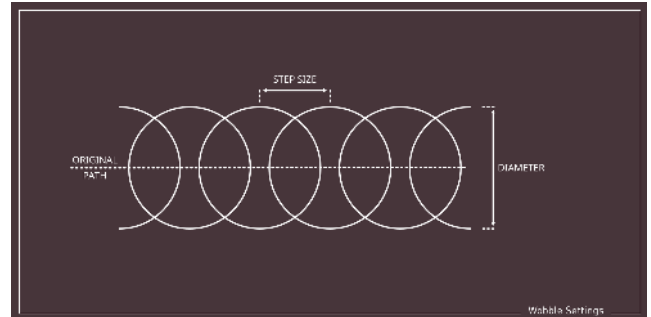

#### Gantry-Specific Settings

These settings will only be available if you are using a gantry laser.

##### Z Offset

If you have Z moves enabled, and your controller supports it, the Z Offset setting can be used to move the laser head closer to the material (inward) or farther away from it (outward). Focusing deeper into the material can sometimes help to cut thicker material, and lifting the laser away from the material can produce a thicker line.

##### Z step per pass

When doing more than a single pass over a shape, the Z step per pass setting allows you to tell LightBurn to raise or lower the laser with each pass by some amount. This is most often used for thick cutting or deep engraving, allowing you to shift the focus point deeper with each pass to help maintain efficient cutting.

### Warning for Z moves

If your system uses auto-focus, you may not be able to push the focus point lower, because most systems treat the auto-focus height as the lowest possible height (Z limit) to avoid crashing the laser head. Be careful using Z moves, as they do have the potential to physically damage your laser by crashing the head into the material.

##### Kerf offset

Kerf is used to mean the thickness of the cut itself when using a cutting tool. If you use a table saw, and the blade is 2mm wide, it has a kerf of 2mm (or just slightly more). A laser burns material to cut, and although the cut is very thin, it does have width, and this width needs to be compensated for if you are trying to make parts that fit together, like a tabbed box, or an inlay. Kerf offset works exactly the same as the Offset tool in LightBurn, but it happens "on the fly" as the cut data is generated for your laser, so it does not alter the original design.

Using outward kerf moves the laser beam outward, away from the shape, and using inward kerf moves it inward, into the shape. LightBurn accounts for the fact that holes in a shape will need to be offset in the opposite direction, as shown here - the solid lines are the original shape, and the dashed lines are the result of shifting the kerf out or in:

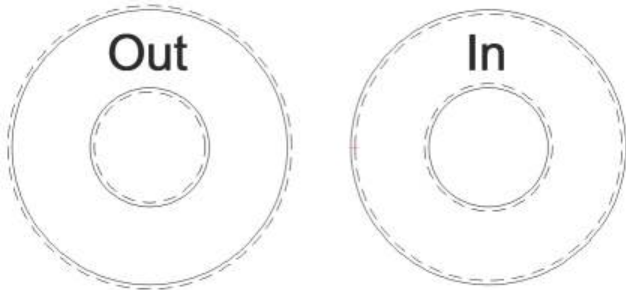

#### Advanced Settings

Under the **Advanced** tab you'll find useful, but less frequently used, options. This tab will not be available if you are using a gantry laser.

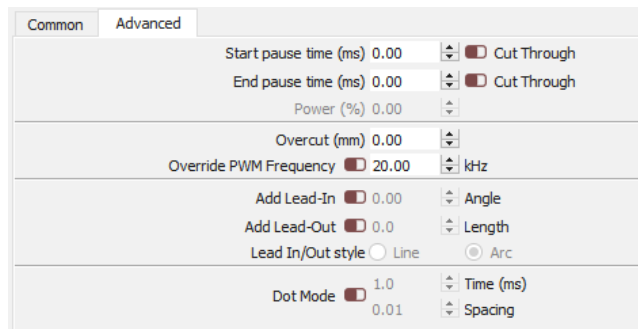

#### Start / End pause time

These options can be used to add a delay at the beginning of a cut, the end, or both. If you also enable the 'Cut Through' option, the beam will be turned on during this pause, which can be used to 'prime' the cut, for example when cutting very thick material. The 'Power %' value sets the power of the laser during this pause.

If used without the 'Cut Through' toggle enabled, it can be used to add a delay to let the gantry settle down after a rapid move, or allow time for an air assist solenoid to engage.

#### Overcut

This option tells LightBurn to keep cutting closed loops for the specified distance, which can help when cutting through thick material, where the start of the cut sometimes doesn't make it all the way through.

#### Override PWM Frequency

If you have an RF Excited tube, this setting allows you to control the PWM frequency of the pulses sent to the laser, and can change the edge finish on certain materials.

#### Override PPI

Only available on Trocen controllers, the PPI setting (Pulses Per Inch) lets you tell the laser to send an exact number of

pulses per inch of travel, instead of varying the beam power directly. This is useful for delicate materials like paper, and is similar to using *Perforation Mode*, but is handled by the hardware itself.

#### Lead In / Lead Out

Lead-in and Lead-out are optional lines or curves added to the start or end of a cut. When cutting thick material, particularly if using 'Cut Through' delays, or cutting metal, there is often a mark left at the start of the cut that is slightly thicker than the rest, and can leave an indent on an otherwise smooth edge. With this setting, you can add a small line to the start or end of a cut, so that mark happens off the cut line itself. The 'Angle' value controls the placement of the lead line - a positive number tells LightBurn to put the lead line outside the shape, and a negative number means to put it inside. You can choose to make the lead a straight line, or a short arc.



The shape above on the left is using an arc set to +45 degrees, so it starts outside the shape. The one on the right is a line set to -20 degrees, so it appears inside the shape.

#### Dot Mode

When enabled, the laser will pause and pulse at regular intervals along the path, instead of cutting continuously. The 'Time' value specifies the pause delay in milliseconds, and the spacing parameter sets how far apart the pulses are. This can be an effective way to do stitching holes, or cut very thin or delicate materials, but the constant pausing can shake the machine - using *Perforation Mode* is often preferable for this reason. This setting is not available on all lasers.

CUT SETTINGS - OFFSET FILL MODE

Common Settings    Advanced Settings

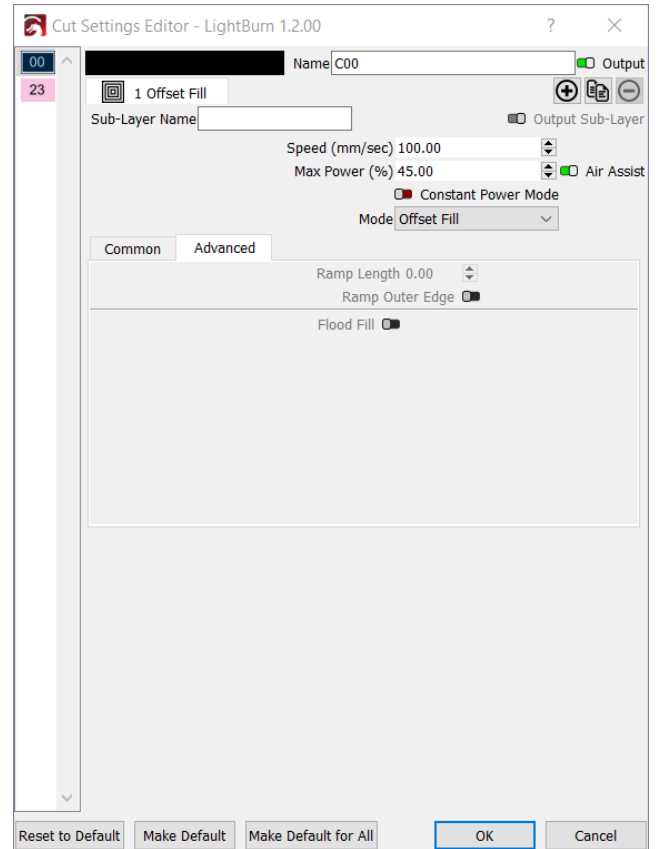
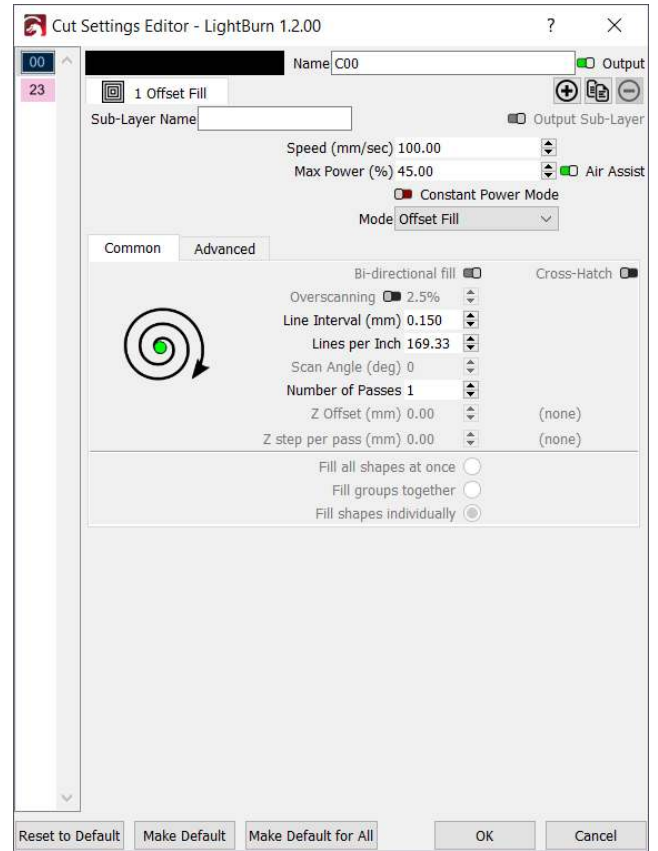

This mode is a recent addition, and will fill an outline with lines that follow the shape of the object. If you have ever worked with a CNC router, it would be called an "offset pocket" operation.

For comparison, a traditional **Fill** is on the left, and an Offset Fill on right.

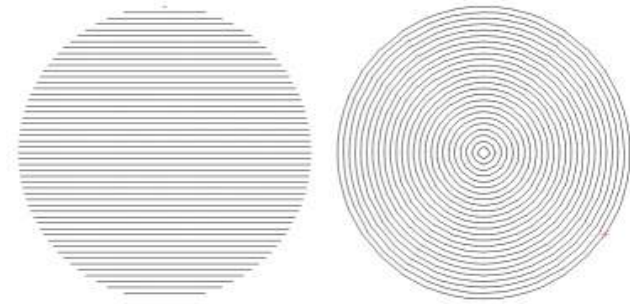

Raster fill is preferred for general use, however offset fill can save time in certain cases if you have a slower machine, or the shape you are filling is hollow, like this:

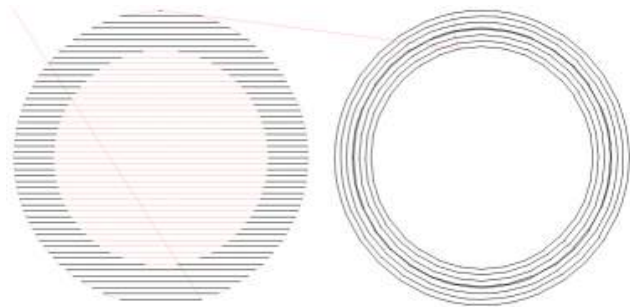

In this case, you can see that the left image has many more traversal moves (non-cutting movement of the laser, shown in red), where the right side does not. Offset fills take considerably longer to generate because the computations to generate the path are much more complex.

Aside from the differences in path generation, settings here are similar to the regular fill mode.

#### CUT SETTINGS - IMAGE MODE

This mode is only available for image shapes, and lets you choose options that control how LightBurn renders the image data on the laser.

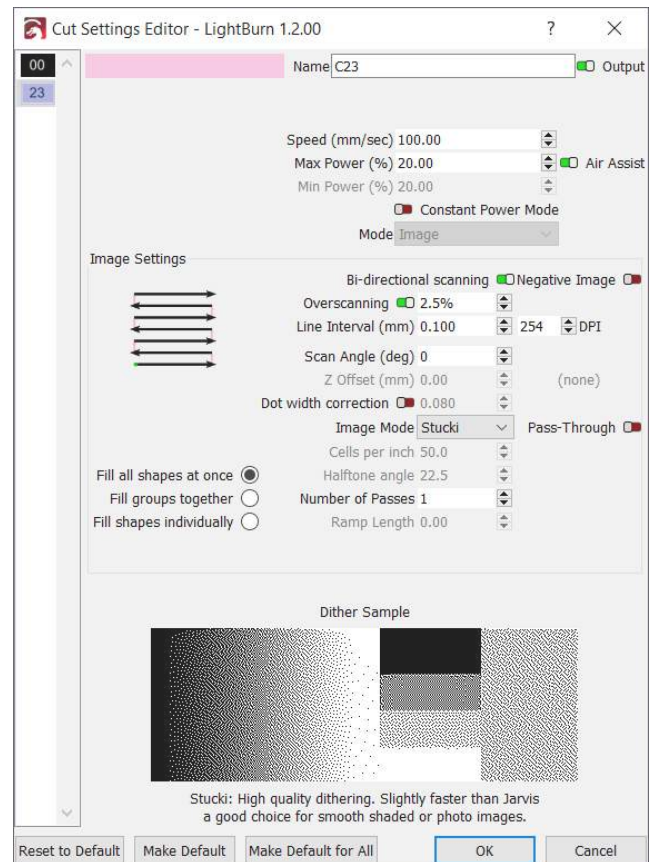

The image above shows the settings available for images. Many of these will be familiar from **Fill mode** with the rest specific to image engraving. Note that on a CO2 laser it's likely that you will be running at a low power and/or very high speed, whereas a diode laser may be run at full power, depending on material.

These settings do not allow you to control things like image brightness or contrast. Instead those are set on a per-image basis and can be accessed via the **Shape Properties** panel.

To see a side-by-side comparison of the source and output image, while being able to change both the layer settings described in on this page *and* the image shape properties, checkout the **Adjust Image tool**.

#### Image Settings

##### Bi-directional scanning

When enabled, the laser will engrave in a side-to-side sweeping motion, engraving in one direction and again for the return direction. When disabled, the laser will engrave traveling one way, then return to the start of the next line, not engraving the return pass.

##### Negative Image

This will invert your image during engraving. Light becomes dark, dark becomes light. This is useful for engraving slate or glass, where burned areas become lighter.

#### Overscanning

When enabled, adds extra moves to the beginning and end of each line to give the laser time to speed up before firing, and slow down afterward. If your machine has low acceleration or you see darker burns at the sides of your fills, you may need to increase the amount of overscanning. If you do not see this setting, your machine is likely a DSP controller and handles this automatically in hardware.

#### Line Interval

Controls the spacing between scanned rows, and indirectly controls 'DPI'.

#### DPI (Dots Per Inch)

Controls the pixel density of the output - this is simply another way of representing line interval that is more intuitive for some. DPI (dots per inch) is just  $25.4 / \text{interval}$ .

#### Scan Angle

Normally 0, meaning the laser will scan back and forth horizontally across the image, progressing from the bottom of the image to the top. If you set this to 180, the laser will scan the image from top to bottom. Setting this to 90 will scan the laser vertically over the image, progressing from left to right.

**NOTE:** If you have a DSP controller, we do not advise using angles that aren't a multiple of 90 degrees. Horizontal and Vertical scanning is supported natively by the hardware, and it will automatically handle over-scanning beyond the sides of the image to get the head to full speed before engraving starts. Scanning at non-90 degree angles is "emulated" using normal cutting moves. It works, but it's mostly useful as a style option, and not recommended for general use.

#### Z Offset

If Z moves are enabled, this setting controls how much to raise or lower the Z axis when executing this fill. Lifting the laser a few mm, for example, can make the beam wider, allowing the use of larger interval values, which can make filling a large area faster.

#### Cells per inch

Number of **Halftone** shading dots to compute per inch. Only enabled when the Halftone **Image Mode** is selected.

#### Halftone angle

Angle of the **Halftone** shading pattern. Only enabled when the Halftone **Image Mode** is selected.

#### Number of Passes

How many times to repeat the entire engraving process.

#### Ramp Length

Length to ramp in and out of the sides of engraved features. Typically used for rubber stamps.

#### Pass-Through

This prevents the image from being resampled internally at all and disables the normal image modes described below. Line interval / DPI will be directly tied to the size of the image. This is best used for images that have been pre-processed for laser engraving outside of LightBurn.

#### Image Mode

The Image Mode setting is arguably the most important setting of them all for images. It will define what your resulting engrave will look like and there are many modes to choose from. Below you can see a description of all these modes, with an example of how that mode changes the look of this original image.



Example: Threshold, Dither, Atkins, On the Stuck Jarvis Newsprint, Halftone, Sketch, Gray



A simple on / off switch if the image is dark / bright at a given location. This should only be used for images that are two-color black/white to begin with, like an image you dithered outside of LightBurn. Don't use this mode for grayscale or color images.



Also called ordered dithering, this is a step above threshold for grayscale images, and uses densely packed on/off dots to approximate shading, using an ordered/regular grid pattern. This is ok for general use, but works best for images with large areas of solid fill, where diffusion dithering can cause unwanted artifacts (see below).



A good "in between" mode for solid color or smooth shaded images. It uses a regular grid of dots to approximate the original image's colors and shading.

## Fill Grouping

These options control which images are filled at the same time on the laser. If you run your laser fast, OR your laser accelerates slowly, it is often most efficient to scan things all at once, so the laser spends most of its time moving at the speed you've chosen, and less time changing direction. If you are engraving slowly, or your laser accelerates fast, or the design contains a lot of blank space, it can be more efficient to fill clusters of close shapes, or just fill the shapes one by one. If you aren't sure, try different options and use the preview to estimate the time.

- **Fill all shapes at once:** The default, this setting means that everything on this layer will be filled at the same time, sweeping back and forth across the whole job. If you are running the laser fast (300 mm/sec or more) this is usually the most efficient option, with some exceptions.
- **Fill groups together:** This setting will fill all shapes in a group at the same time.
- **Fill shapes individually:** This setting fills all shapes one by one.

## TABS / BRIDGES

Sometimes it is helpful to include tabs (sometimes called bridges) in objects that you are cutting out so that they do not fall out immediately but can be removed later. The concept comes from the CNC world but is much simpler in the context of a Laser. Simply put, it's where you skip a very small section of a cut, often less than 1mm in length. In the example below, the left square has no tabs applied, while the right has a single 1mm wide tab on each side.

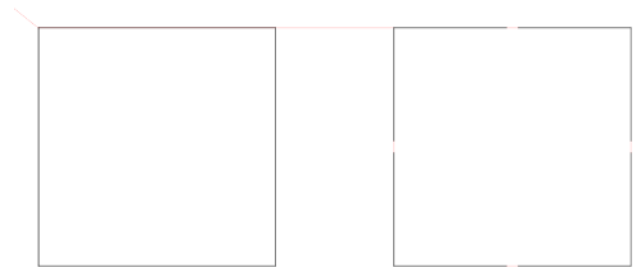

### Basic Usage

First, note that you will need to disable **Beginner Mode** in the LightBurn Settings otherwise the tabs functionality will not be available. Once that is done, you will see the "Add Tabs" tool is available:



You can only add tabs to shapes that are in **Line** mode. Once the **Add Tabs** tool is selected you will see the **Insert Tab**

cursor (  ) when hovering over a shape which you can add a tab to.

Simply click where you would like a tab, and a red circle will appear where you clicked, denoting that a tab will be placed there.

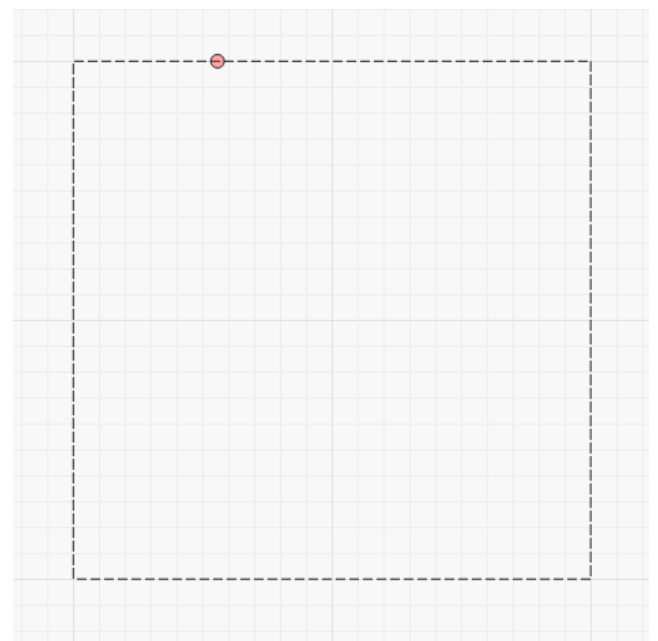

Tabs default to 0.5mm in width and you can place many tabs on any shape. The system will, however, limit how close any two tabs can be based on the currently set tab size.

If a tab needs to be moved, simply click on it again and drag it to a new location, even on another shape.

Finally, you can delete a tab by double-clicking or shift+clicking the tab.

#### Advanced Usage

In a **Line** mode cut setting's option dialog you will now see a **Tabs / Bridges** section which allows more control.

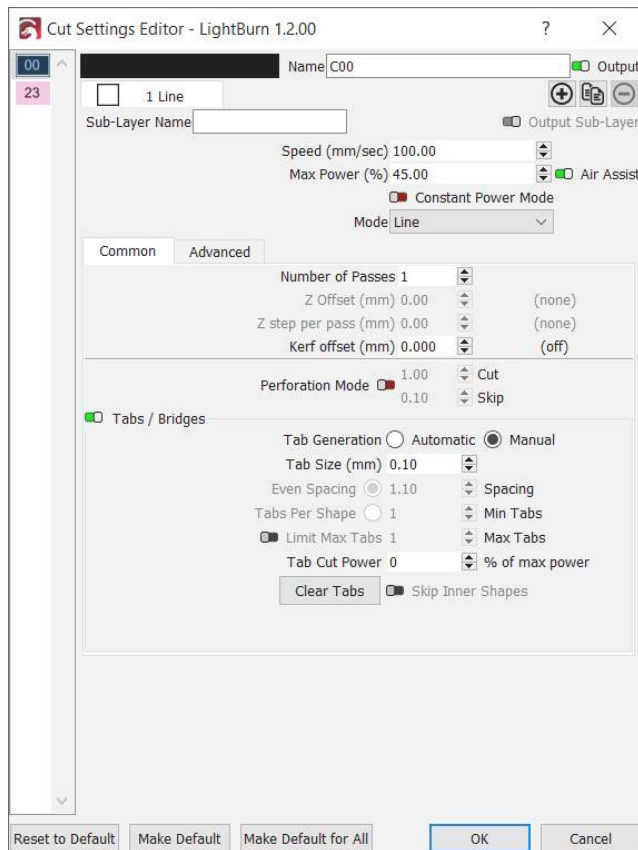

#### Global Enable / Disable

The **Tabs / Bridges** group has a checkbox in the top-left. Flipping this to off will suppress any tabs on that cut layer without losing any previously configured tabs or tab settings.

#### Tab Generation

- **Manual** - Any tabs must be manually placed using the methods described above.
- **Automatic** - Tabs will be placed on all cut layer shapes, based on the values of **Even Spacing**, **Tabs Per Shape**, and **Skip Inner Shapes**.

#### Tab Size

Defines the total length of any tabs in whatever the currently configured system unit type is (mm or inch). The system will skip cutting for this distance, if possible.

#### Even Spacing

When automatically generating tabs, each contiguous path section will have at least one tab applied at the very start of the path and then again at this distance interval (mm or inch depending on unit settings).

#### Tabs Per Shape

When automatically generating tabs, using this option will place this number of evenly spaced tabs on each contiguous path section for each shape on the cut layer.

#### Limit Max Tabs

This option allows you to set an upper bound on how many tabs each object can have automatically generated.

#### Tab Cut Power

If set to anything other than 0%, tabs will have pulsed cuts across the distance of the tab instead of just skipping it completely. In the example below, the top tab is set to 25% whereas the bottom tab is set to 75%.



Not all laser controllers can reliably vary the power mid-cut so this was a way to implement "partially cut" tabs in a consistent way. By increasing the amount it pulses on during the tab you can further weaken the tab overall.

#### Skip Inner Shapes

When enabled any shapes that are completely contained by another shape in the same cut layer will not have automatic tabs applied. This does not effect manual tab placement.

#### Clear Tabs

Delete all tabs (manual or automatic) from every shape on this cut layer.

## Primary Docs UI Libraries

### Art Library

The Art Library is a way to quickly store and recall artwork that you use on a regular basis and want quick access to when designing.

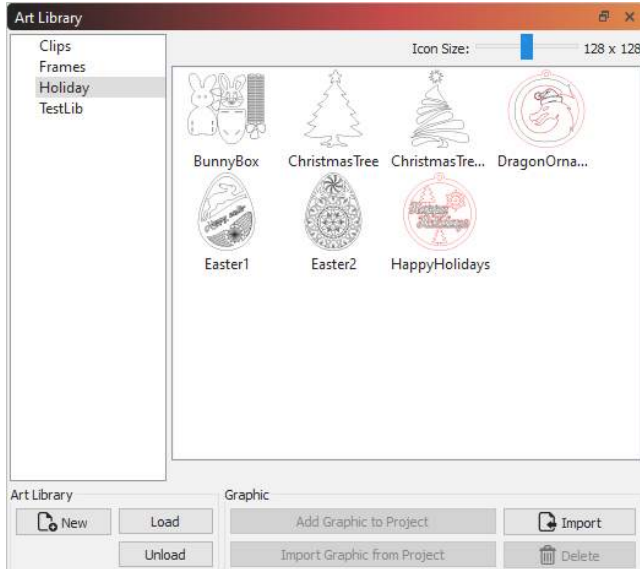

On the left side of the window it shows the libraries that are currently loaded, and the right side shows the artwork in the currently selected library. Artwork can be easily imported into the library from files on your hard drive, or from a selection in your current project. When you want to use something from the library, just grab the thumbnail from the right view and drag it into your project.

**Note:** The library *only* stores artwork, much like the contents of your AI, SVG, DXF, or image files. It does not store the cut or fill settings applied to the artwork.

#### Library Files

Each library you create is a file on your hard drive containing all the graphics inside it in a compact form. You can copy library files between computers to share the contents. LightBurn remembers which libraries you have loaded. Unloading a library file just removes it from your list of loaded libraries, but doesn't delete the file or its contents, which makes it easy to bring in seasonal or holiday specific libraries when you need them, then unload them to reduce clutter when you don't.

To create a new (empty) library, click the 'New' button and choose a location and a name to store the library file. Once created and selected, you can immediately start adding content to it.

#### Adding artwork to a Library

If you have files on your hard drive that you want to add you can click the Import button. This will let you import multiple files at once if you want to, and each one will become an entry in the current library. You can also select something in your current project and click 'Import Graphic from Project' to add the selected artwork to the current library.

You can also right-click in the library view, like this:

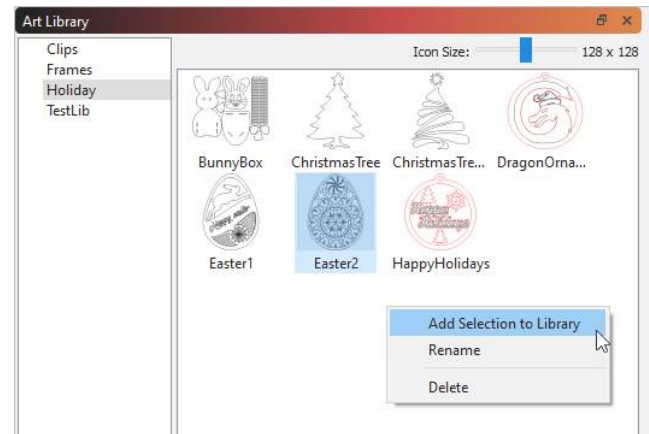

From the pop-up menu, you can add the current selection to the library, rename the selected library graphic, or delete it.

#### Adding artwork from the Library to your project

When you want to use an item from the library, locate it in the thumbnail view on the right, then simply drag it into your project wherever you would like it to appear, and drop it. You can also click 'Add Graphic to Project' in the buttons along the bottom.

#### Loading and Unloading Libraries

If you have libraries that you use rarely, or are seasonal (like Halloween, Christmas, Easter, Spring, Fall, etc) you can unload them when you are no longer using them by selecting the library on the left, and clicking the 'Unload' button. This just removes it from the view, but does not delete the file from your hard drive. When you need it again, click the Load button, and locate the file on your hard drive. It will be added back to the list and usable until you unload it again.

## Primary Docs UI Libraries

### Material Library

LightBurn's Material Library provides a way to store and organize lots of presets for different operations on different materials, and have a way to quickly apply them. This is entirely user-generated - You set up a cut layer however you like and save it to a Library. You set a material type, thickness (if appropriate), and a short description.

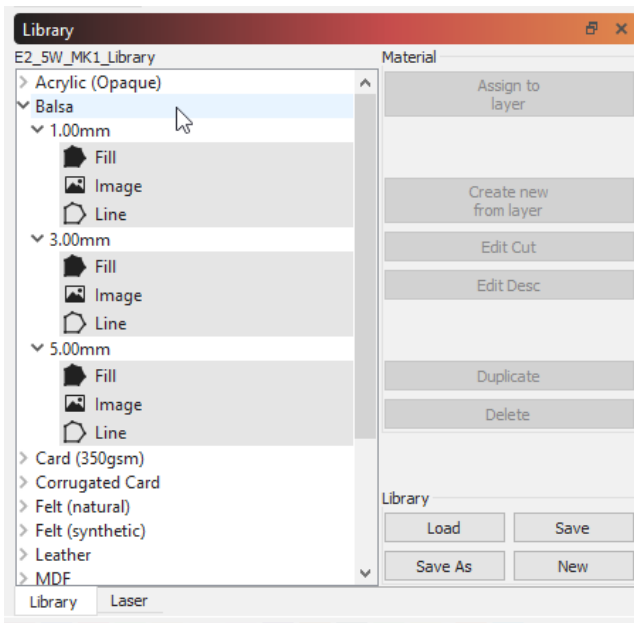

Any Library setting can be applied to a cut layer by selecting the library entry and assign it to the layer. Settings are copied, so if you need to make edits to the setting you won't hurt the copy in your library - you can edit those independently.

#### UNDERSTANDING MATERIAL LIBRARY

Material Library is a simple yet powerful component of Lightburn intended to assist in the management of the laser cutting process.

The first time you launch LightBurn, an empty Material Library is automatically set up and ready for new entries. You can easily add to, edit and manage cut settings in this library. Saved libraries can be loaded and shared from local or network accessed and even cloud based storage for convenience. To get started, make sure you can see the Material Library window.



In the top menu, select "Window" to ensure that "Library" is checked on. If not, select it to turn the window on. This will display the Material Library window in the lower-right of the display next to a box called "Laser".

#### ASSIGN TO LAYER

LightBurn allows you to directly have a layer's settings linked to that of a material library, so that any changes made to your library reflect across your designs without much additional work.

To use this, select an object with the layer you intend to link to, and the material you'd like to link to it in the Material Library, and click "assign to layer".

At the bottom of the Quick Edit area of the Cuts / Layers window, you'll now see an "unlink" button, as well as the location of it within your material library.

#### Note

If your current selected object has **Sub-Layers** in any capacity, using "Assign To Layer" will cause the color of selected object to reflect the layer properties (including Sub-Layers) of the linked material.

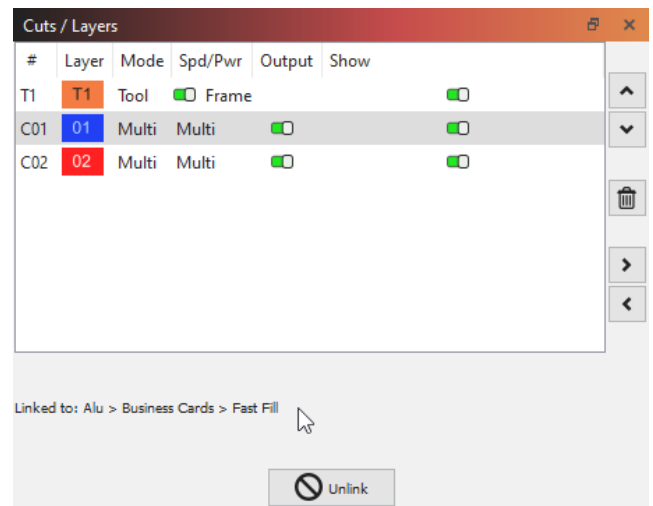

#### CREATE NEW FROM LAYER

LightBurn makes it easy to build out your library using the current cut settings assigned to any cut layer.

1. Select one of your cut layers then click the *Create new from layer* button in the "Library" window.

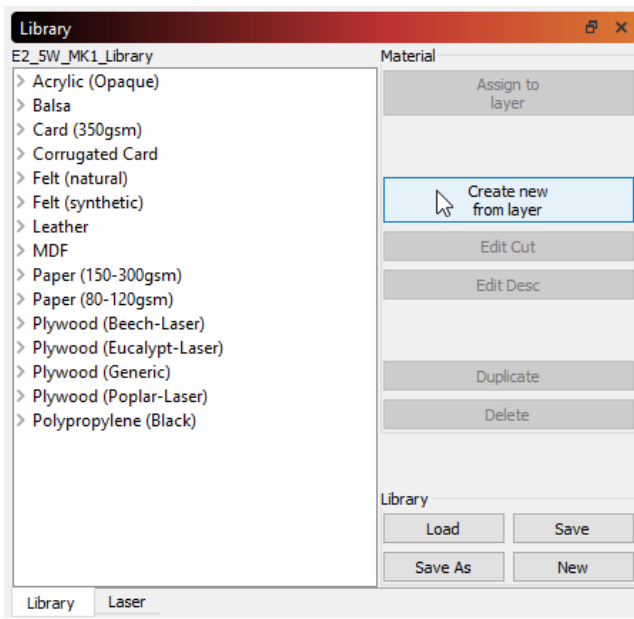

1. Fill out the details sheet providing a *Name*, *Thickness* (if appropriate) and a short *Description* of the cut layer parameters. Once completed, click the *Ok* button to save this new entry into your library.

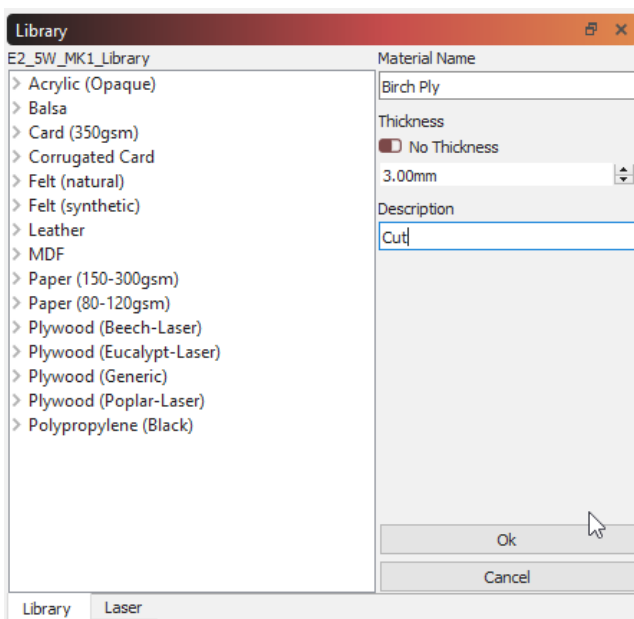

1. Now you can use this new entry titled "Birch Ply" anytime in the future and easily assign it to a new cut layer.

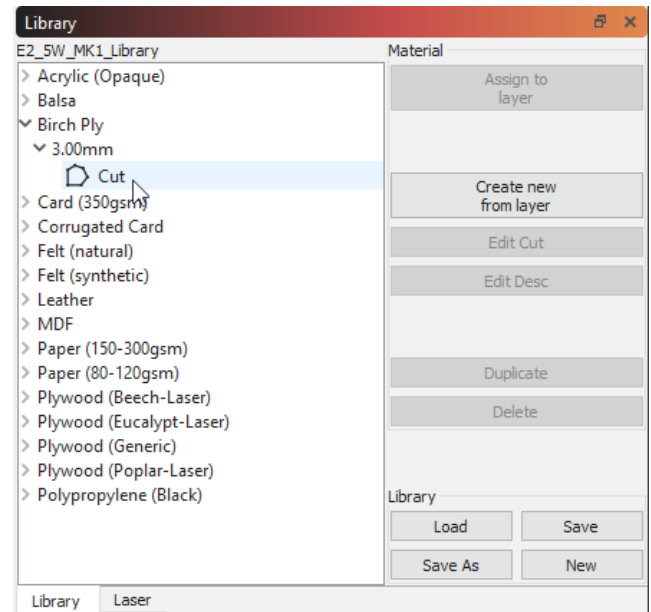

There are several helpful ways to facilitate adding to and managing your library covered later in the "Manage existing Library" section below.

#### Note

If your current selected layer has **Sub-Layers** in any capacity, using "Create new from layer" will assign all Sublayer details to that object, and render with "Multi" in the **Cut Settings Editor**.

#### SAVE A LIBRARY

As you fill out the Library with your favorite materials, it is always a good idea to periodically save your additions. To do this, click the **Save** button.

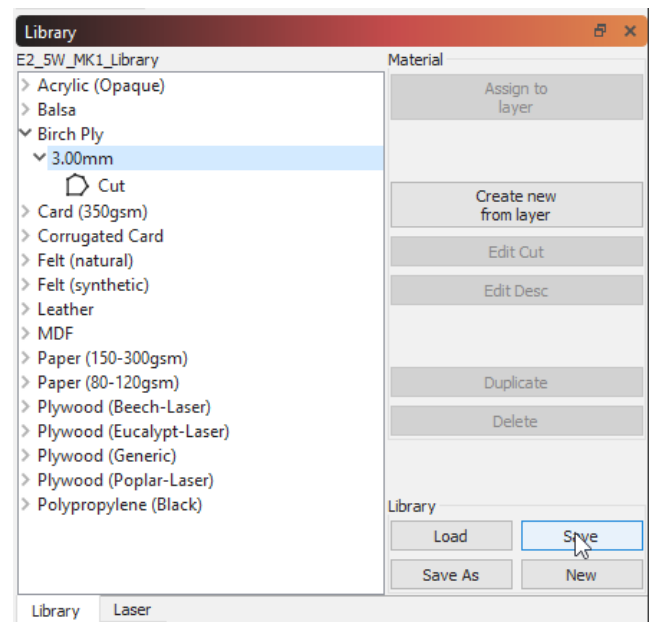

### ASSIGN LIBRARY SETTINGS TO LAYER

Now that you have some entries added to your library, you can use them to quickly and easily apply these settings to your work. Settings are copied, so if you need to make edits to the setting you have applied you won't hurt the originals in your library.

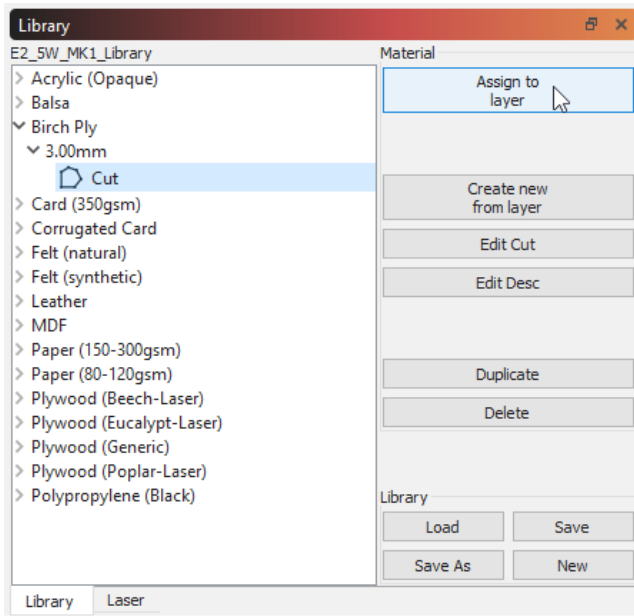

### NEW LIBRARY

Depending on your workflow, you may find it desirable to have several libraries to work from. You can start a new Material Library anytime by clicking the *New* button at the lower-right corner of the "Library" window. Now you are presented with a new, blank library ready to fill out and save.

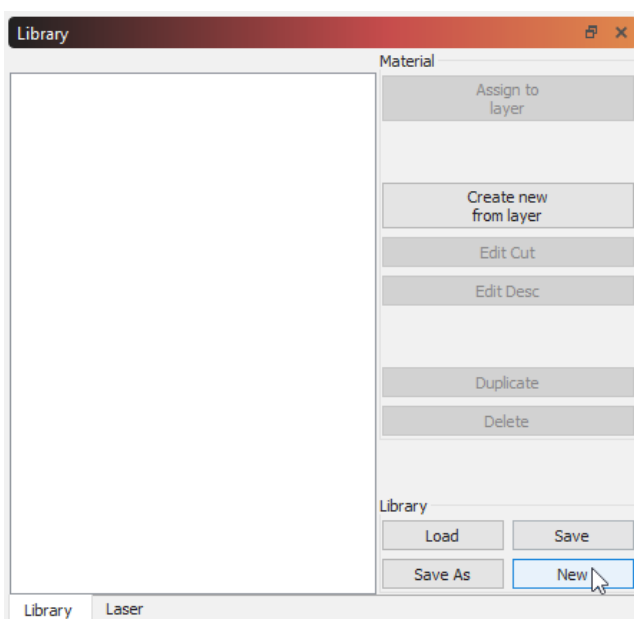

### LOAD A LIBRARY

Selecting *Load* provides access to your previously saved Libraries. Once clicked, a file finding window will open allowing you to point to a saved library. Select library of

choice and click the *Open* button. Your chosen file will then become the active library for use.

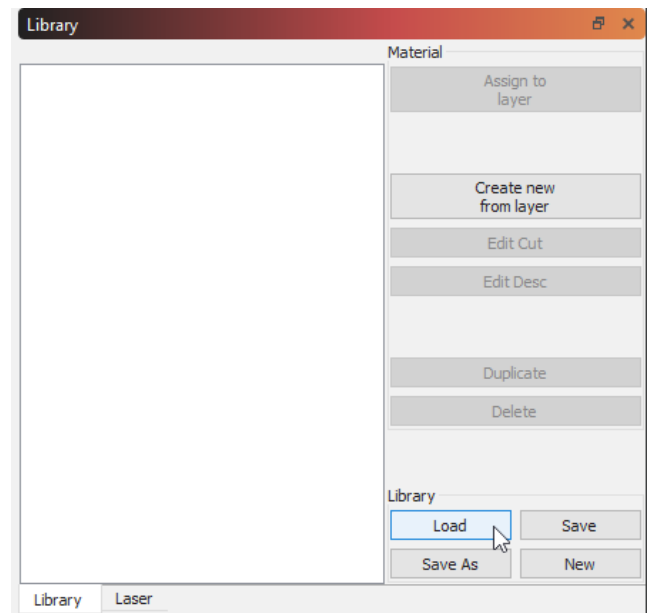

### MANAGE EXISTING LIBRARY

Existing Library entries can be managed in several helpful ways. Changing existing cut settings and descriptions, quickly duplicating entries, removing unwanted entries or producing copies of the entire library can be done in a snap.

**Note:** These items are only selectable when "Description" is selected.

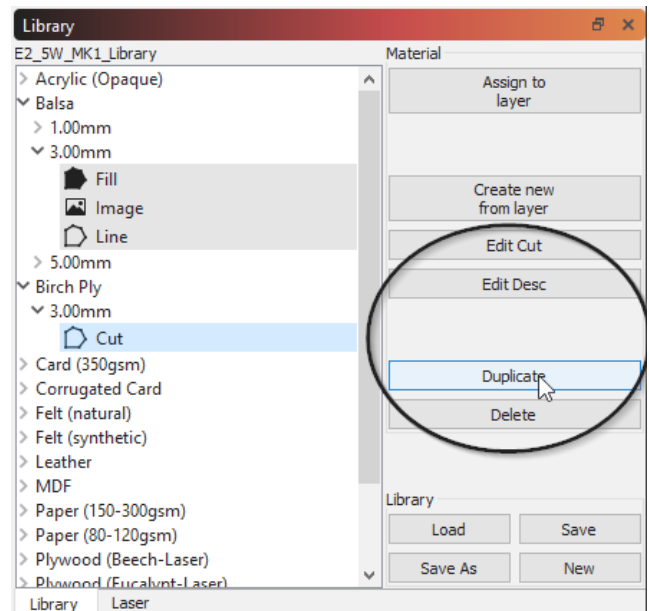

### Edit Cut

Click *Edit Cut* to open the "Cut Settings Editor". This allows you to change any of the cut settings as you would normally and saves them back to the library.

**Edit Description**

Click *Edit Description* to modify the Name, Thickness and Description for the highlighted entry.

**Duplicate**

Click *Duplicate* to create a copy of the highlighted entry. This can be helpful in quickly adding to your library.

**Hint:** Combined with *Edit Description* and *Edit Cut* you can keep the same "Material Name" and "Thickness" to create 'nested' entries (e.g. 3mm cut, scan and image). Keeping just the "Name" while changing the "Thickness" allows nesting of different thicknesses of the same material.

**Delete**

Click *Delete* to remove a single cut setting entry from the library.

**Save As**

Click *Save As* to create a complete copy of your active library and saves it under a new name of your choice.

**ADVANCED USAGE****Multiple machines/users access to shared Library**

Multiple machines can access a single Material Library file hosted on a network drive or from cloud service storage (e.g. DropBox, Google Drive, iCloud, OneDrive, etc.).

1. Create a library on one machine and save it to your network or Google drive, DropBox, etc..
2. Point to that saved library file after hitting 'Load' in the 'Library' screen of LB for each machine.
3. If you edit that library the changes will be there of both machines as they are pointing to the same file.

**Primary Docs   UI   Ruida****File List Window**

This window is only supported on DSP controllers that allow hosting files on the controller, and allows you to see and manage the files hosted there.

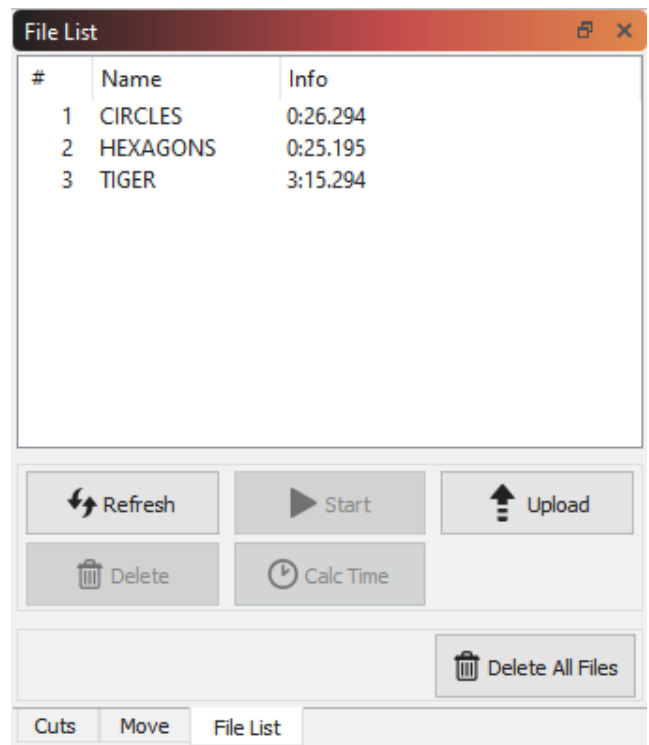
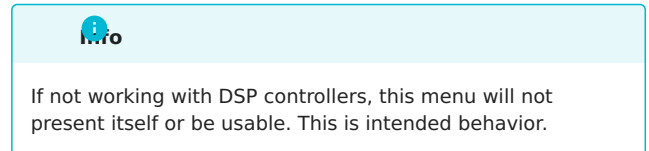

Hit the Refresh button to query your controller for the list of hosted files. You can select a file and press Start to run it, Delete to remove it from the controller, or Download to save it locally. Pressing Upload will let you choose a local cut file to send to the controller (this is not the same as the current job, which you can upload with the "Send" button in the [Laser window](#)).

It is worth noting that some controllers, particularly Ruida, can take significant time to delete a file from the beginning of the list if there are many files (or large files) following it. We suspect that the controller is compacting the internal storage when you do this, so if you are planning to delete multiple files, it is faster to delete from the end of the list first.

The 'Delete All Files' button is generally much faster than deleting files one by one.

The 'Calc Time' button is available only on supported controllers (Ruida) and will compute the time taken to run the job on the controller itself. With engraving jobs this can take a considerable amount of time to do, as the controller is



basically simulating the job internally, and the math is complex. When it completes, the duration to run the file will be shown in the 'Info' column.

**Primary Docs**   **UI**   **GRBL**

### Console Window

On GCode machines, the console window allows you to directly input commands and see messages from the controller itself.

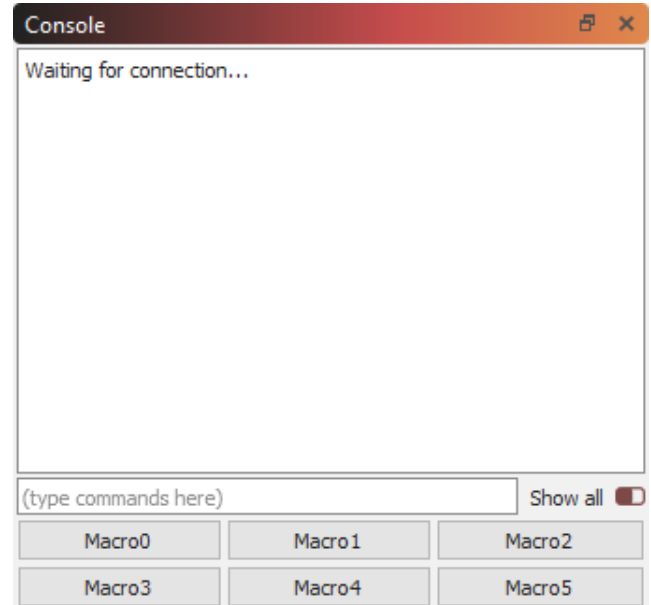

You can type a command in the text box and the console will output the results. Examples would be manual G-Code commands or retrieving configuration details from your connected device.

If the controller encounters an error during execution, it will be shown here as well.

If you have commands that you use frequently, you can store them in one of the macro buttons. Right-click a button to bring up the options to change the macro contents. Give the button a meaningful name, and enter one or more commands to send to the controller when the macro button is clicked.

Enable the 'Show All' toggle switch to display all commands sent between LightBurn and your controller.

**Note**, the console window functions are not available on DSP controllers, like Ruida, Trocen, or TopWisdom as these are not GCode based, and do not accept GCode commands.

Primary Docs UI Settings

Settings 

The Settings window in LightBurn controls global user preferences for LightBurn - these are the settings that apply regardless of what laser(s) you set up. These are split into two pages - Display / Units settings and File settings.

DISPLAY & UNITS SETTINGS

The first page is the display and units settings, shown below:

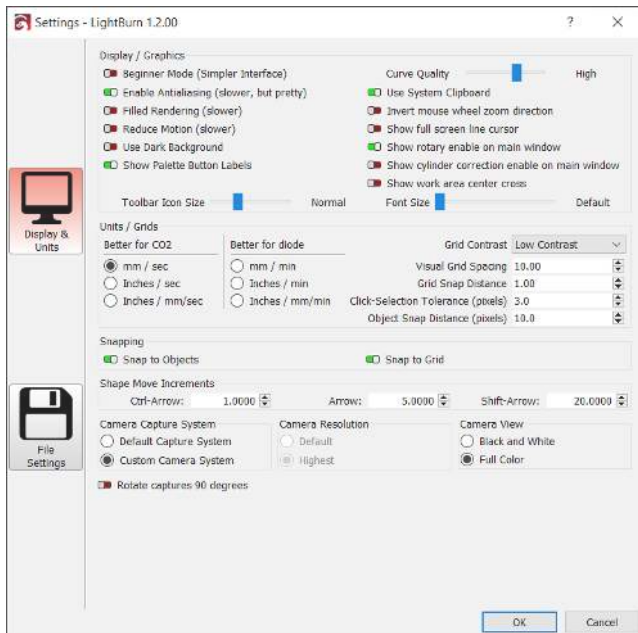

Display / Graphics

Settings in this section control the display and presentation of LightBurn.

Beginner Mode

Beginner Mode simplifies the interface by removing options new users are unlikely to use. It can be turned on and off at any time from this screen. When Beginner Mode is active, you'll see the message below in the title bar.

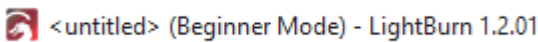

More Info

Although Beginner Mode can make it easier to get started, it also means that your interface will look a little different than most video tutorials or screenshots you'll see.

If you're searching for a button or feature and you don't see it, it might be because of Beginner Mode, but it could also be because you're using a machine that doesn't support the feature you're looking for. LightBurn's interface adapts to only show you the features that are compatible with your machine type.

Curve Quality

This controls the precision LightBurn uses in displaying curves on the screen. All curves are displayed as a series of short lines, but the higher this value is, the shorter those lines will be. You can see the difference below.

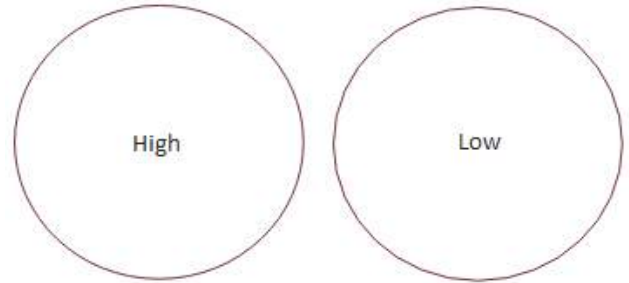

If you're working with files containing thousands of curves and your computer is lagging you may want to try reducing this value. If you need your curves to be very precise, you may want to increase it.

Enable Anti-aliasing

Anti-aliasing smooths the appearance of lines on your screen. Enabling anti-aliasing will make your design previews look much nicer, but does increase demand on your machine. If you notice your computer lagging, especially on older computers or when working with very complex designs, you may want to try disabling this setting.



Filled Rendering

When enabled, LightBurn will display filled shapes directly in the edit window. This takes longer than rendering the wire outlines, and it can hide things from you behind those filled shapes that may still be sent to the laser, so we recommend using this only for spot-checking your work, and not for general editing.

Use Dark Background

Shows the main edit window using a dark color scheme which may be easier on people with light sensitivity.

Show Palette Button Labels

This setting, enabled by default, shows numbered labels on the color palette swatches, making it easier to tell the more similar entries apart. This is also useful for users with color blindness or other vision impairments.

Use System Clipboard

Enabling this makes copy and paste operations slightly slower, but allows LightBurn to:

- Copy and paste across different runs of LightBurn, or between two running copies of the app
- Paste images copied from other software or web browsers
- Paste text directly into the edit window, auto-creating a text object for you

#### Invert mouse wheel zoom direction

This toggle allows users to override the scrolling behavior within LightBurn to better match their preferences for macOS or Windows.

#### Show full-screen line cursor

When enabled, this feature draws a cross-hair that spans the entire edit screen, which can make it easier to line up graphics.

#### Show Rotary Enable on Main Window

This adds a toggle to the main window in the Laser pane to easily confirm whether rotary is enabled or not at a glance.

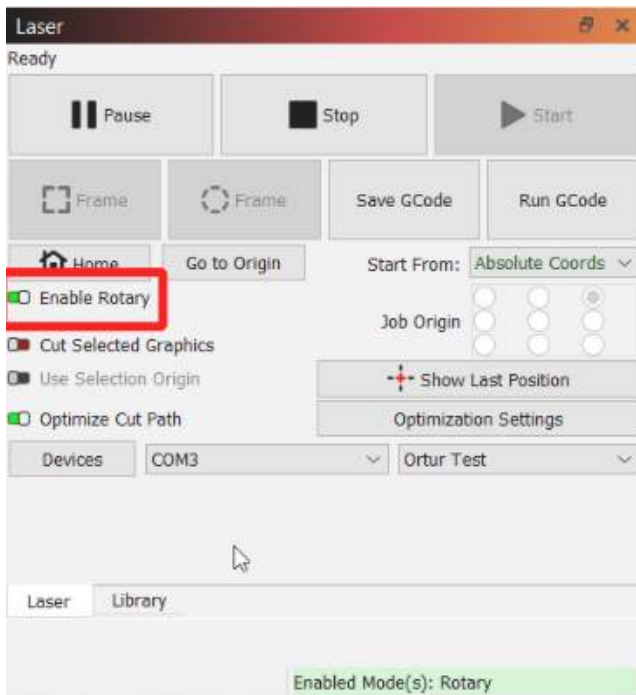

#### Show Cylinder Correction Enable on Main Window

This adds a toggle to the main window in the Laser pane to easily confirm whether cylinder correction (for engraving of cylindrical objects without a rotary) is enabled or not.

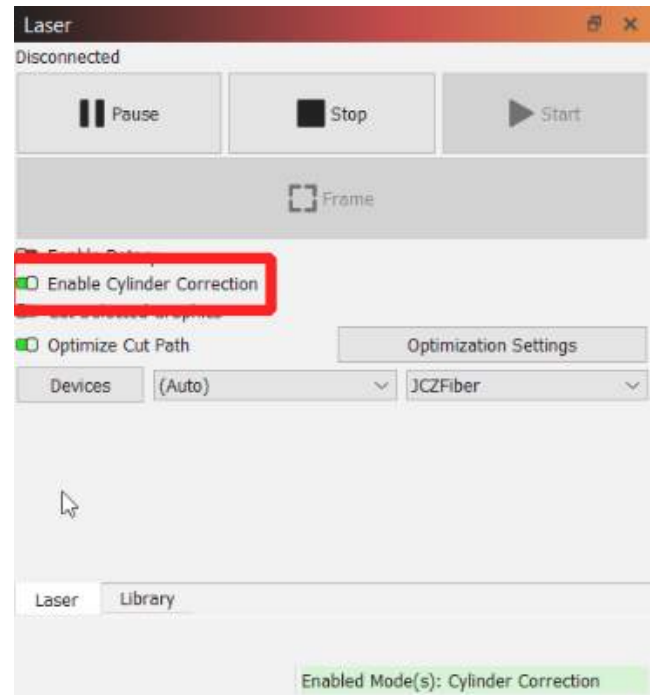

#### Toolbar Icon Size

This slider allows you to manually change the scaling of icon elements in the LightBurn UI. This allows for manual overrides for HiDPI screens, UI scaling, and hard of seeing users. Not all UI elements may fit on screen if increased too high.

#### Font Size

This slider allows the end user to decrease or increase the font size for LightBurn window text anywhere in the program. This allows for manual overrides for HiDPI screens, UI scaling, and hard of seeing users. Not all UI elements may fit on screen if increased too high.

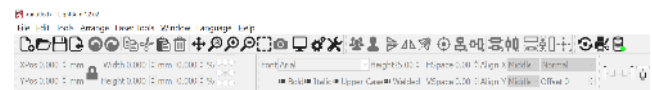

#### Info

Setting either of these sliders to be too high may result in clipping of UI elements, due to being an assumed size. If you scale them up or down such that you cannot reach the menu items to open the menu and shrink them, please use the trick listed [here](#) to reset; hold **Shift** while launching LightBurn.

#### Units & Grids

##### Inches / mm

LightBurn internally operates in millimeters, but can display in either millimeters or inches. Speeds can be represented as either units per second or units per minute. Users with diode lasers will likely prefer the units per minute setting, whereas CO<sub>2</sub> lasers generally express speeds using units per second.

## Grid Contrast

This allows you to adjust the brightness of the grid in LightBurn's main window relative to the background.

## Visual Grid Spacing

The visual grid is set to 10mm by default. Note that this is independent of the Grid Snap setting below.

## Grid Snap Distance

Positioning of lines and other primitives will snap to the Grid Snap distance unless overridden using the Ctrl key. The default for this is 1mm.

## Click Selection Tolerance

This is how close you have to be to a line or vertex, in screen pixels, to click it. Increase this number if you have trouble selecting things, decrease it if you find yourself selecting things you didn't mean to.

## Object Snap Distance

Controls how close, in screen pixels, your cursor has to be to an object vertex or center to engage the object snapping behavior.

### Snap to Objects / Snap to Grid

LightBurn has two snapping behaviors which can be enabled / disabled here. Snap to Objects will snap your pointer location to the nearest object center or vertex when creating new objects, or drawing lines, making it easier to connect and align shapes. Snap to Grid will snap your cursor position to the nearest grid location, as specified by the Grid Snap value. Note that the Grid Snap and the Visual Grid do not have to be the same.

### Shape Move Increments

When moving objects with the cursor keys in the edit window, these values control the distance to move the selection, when using the arrow keys by themselves or with the Control or Shift modifiers.

## FILE SETTINGS

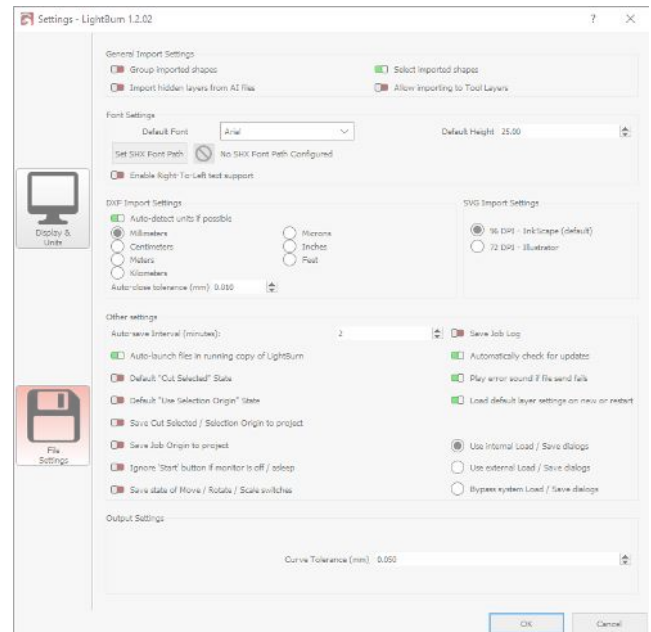

### General Import Settings

#### Group Imported Shapes

This toggle groups shapes imported from a single file together automatically so they don't get scattered in a complex design.

#### Select Imported Shapes

This permits LightBurn to automatically select the shapes imported from a file in your editor to adjust and edit them as needed without needing to manually select them.

#### Import Hidden Layers from AI Files

When importing AI (Adobe Illustrator) files, you may want to import layers hidden in the source file for construction, design, etc for lasering.

#### Allow Importing to Tool Layers

Allows files to be imported directly to LightBurn's tool layers.

### Font Settings

#### Default Font

This is the font LightBurn will attempt to use for all blocks of text made with the **Create Text Tool**.

#### Default Height

This is the default height (in millimeters) of text LightBurn will attempt to make when using the **Create Text Tool**.

#### Set SHX Font Path

LightBurn allows the use of **SHX fonts** for single-line & "quick" text to laser. LightBurn will attempt to load them from the folder specified in this dialogue.



It's suggested that this folder is placed in a location you can easily access, your Documents folder, where you store your LightBurn projects, etc. It is *not* suggested this is stored within the LightBurn application folder (ie. `C:\Program Files\LightBurn\`).

### Enable Right-to-Left Font Support

This allows LightBurn to render and utilize fonts for languages that are intended to be used right-to-left, such as Urdu.

#### DXF Import Settings

### Units

DXF files do not store the measurement system that was used to create them. If you create an object that is 5 inches wide, it might import as 5mm wide, because LightBurn can only see the '5'. Similarly, if your object was created in microns, it might import huge. Set this value as appropriate before importing DXF files to ensure correct scaling.

### Auto Close Tolerance

DXF files are often saved as a collection of discrete pieces, instead of continuous paths. The Auto-Close Tolerance value tells LightBurn to connect any lines or curves that are on the same layer and closer together than this value.

#### Other Settings

### Auto Save Interval

You can set the frequency of your auto-save by adjusting the value in minutes here. Setting the auto-save interval to 0 disables the automatic backups.

### Auto-launch files in running copy of LightBurn

This toggle attempts to open any LightBurn project files opened on your computer within a running copy of LightBurn, rather than opening an additional copy of the program.

### Save Cut Selected / Selection Origin to Project

This saves the cut selected and selection origin items to the file you're currently editing in, for any number of files.

### Save Job Origin to project

This saves specific information about the origin of your job to the project. One example of a potential use is a "custom origin" when using a jig or fixture for your laser.

### Ignore 'Start' button if monitor is off / asleep

This toggle prevents you from accidentally starting the laser by pressing the wrong key when waking the computer. This is particularly useful on lasers that don't have enclosures with safety interlocks, such as most diode and galvo lasers.

### Save state of Move / Scale / Rotate switches

This stores the state of the Move, Scale and Rotate switches to persist across multiple uses.

### Save Job Log

This instructs LightBurn to save which project file was run, on what laser profile, and at what time.

### Automatically check for updates

This permits (or denies) LightBurn the ability to automatically check for updates to itself, and inform you of them. This may be useful if your license is out of date and you want to hide the update notification.

### Ignore out-of-bounds shapes if possible

This instructs LightBurn to not send shapes outside your work area to your laser, permitting use as a construction area.

### Play error sound if file send fails

This produces an audible chime in the event uploading a file to a DSP controller fails.

### Load default layer settings on new or restart

This resets the per-layer settings of the main LightBurn editor any time a new design is made or the program is restarted. If this option is used, it may make sense to also use **Material Libraries** to store these settings and make them easy to reuse.

### Use Internal Load / External Load / Bypass Load

These settings permit you to use non-native system dialogues to perform file/save/open operations with LightBurn. This can be useful to avoid crashing or hanging on certain programs modifying or using native dialogs.

#### Output Settings

### Curve Tolerance

This setting is similar to the Curve Quality setting above, except that it controls the quality of output to the laser. Because it specifies the maximum amount of error allowed, the *lower* the value, the more accurate the curve will be. A value of 0 would be "perfect", but would create very dense data, as some lasers can only process line segments. Most users will be fine leaving this at the default value of 0.05 mm.

## Technical Details



In the above image, the blue curve between the two points is the ideal shape. The black line is a straight line between them, and the red line shows the error (how far the line is from the curve). LightBurn measures this error, and if it's equal to or lower than the Curve Tolerance value, it outputs the straight line. If not, the curve is subdivided into two linear segments and the process repeats with each new segment. Those segments are shown below in violet, along with their new error values. You can see that the two new lines do a much better job of approximating the original curve.



Most people will probably never need to change this - the default is 0.05mm, which is about 1/2 the width of a typical beam. Note that this is the *maximum* error value allowed, so typical output will be better than this, and this only affects curves, not straight lines or vertices, which are exact.

[Primary Docs](#)   [UI](#)   [Settings](#)

### **Device Settings**

After initial setup, you can access device settings under the Edit > Device Settings menu.

GRBL Ruida Galvo

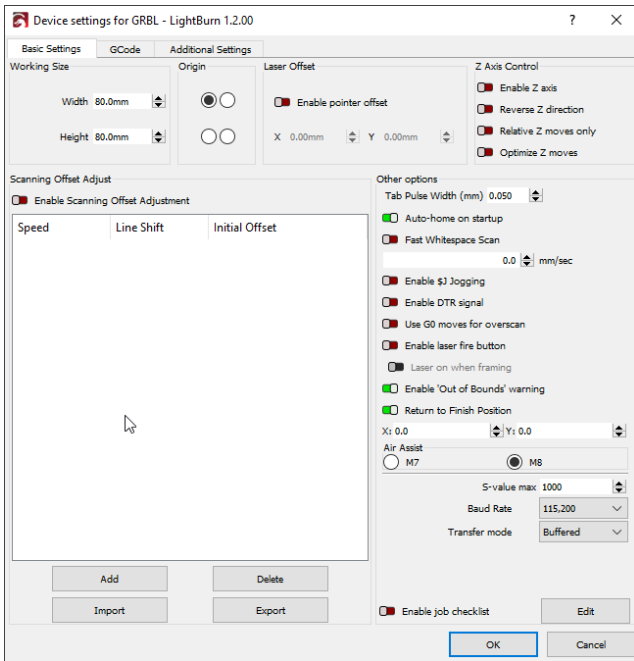

WORKING SIZE

This is the working size of your laser bed. Set this to the maximum X and Y travel for your laser. Note that this setting on GRBL & DSP devices does not affect the laser itself, it's just to tell LightBurn how large the work area of the laser is.

ORIGIN

This is the origin corner or 0,0 location for your laser. If you have a GCode based system, this is almost always at the front left, regardless of the location of your limit switches.

If you have a DSP laser, like Ruida or Trocen, the origin is usually where the limit switches are placed, and will be the corner the laser seeks when powered up.

If your laser output is mirrored horizontally or vertically, move the dot to the opposite corner, horizontally or vertically, depending on the direction that the output is mirrored, and that will correct it.

LASER OFFSET

If your laser has a red-dot pointer that is not aligned with your beam, you can enable the Laser Offset value to compensate for this when framing and positioning.

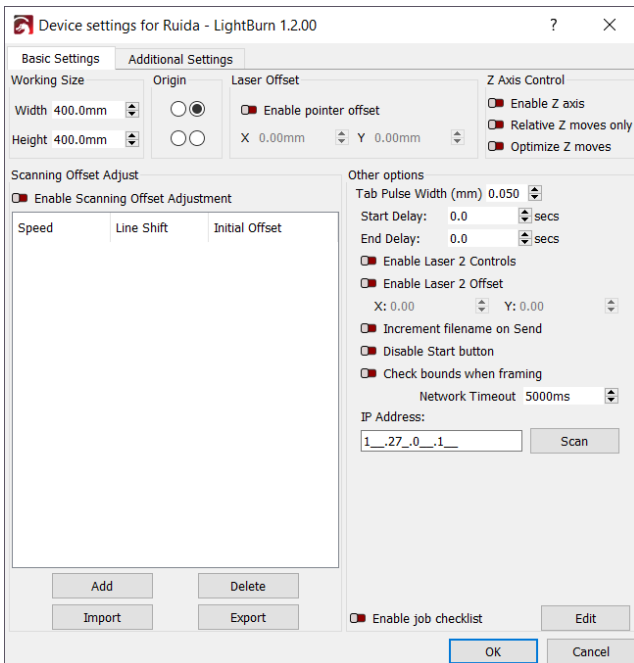

Z Axis Controls

**Enable Z Axis:** turn this on to allow LightBurn to control the Z axis of your machine, IE the height of the laser above the workpiece.

**Note**

Enabling Z control means that LightBurn will **always** emit Z values for a running job, and therefore requires that you set *either* the "Relative Z moves only" toggle below, *or* a material height value on the main cut panel. *If you to not set relative mode, and do not set a material height, the default of 0 may cause LightBurn to raise your bed to a point where the workpiece could contact the head of your laser.*

Reverse Z Direction

Most DSP systems have "0" as the highest point, with positive numbers moving the laser head further from the bed, however some systems reverse this. Toggle this switch to change the overall direction for Z moves.

Relative Z moves only

This setting tells LightBurn to read the height of the machine when the job starts, and uses that height as the starting point for all Z moves, ignoring any specified material height. This is the simplest way to work, as you just set your focus manually, and LightBurn will perform all moves relative to whatever height your machine is at when the job starts. **Note:** for DSP systems this requires that you are connected to the machine.

Optimize Z Moves

By default, LightBurn will always retract the Z back to the initial height (the material height) after completing a shape with a Z offset. This is done for safety. Enabling 'Optimize Z

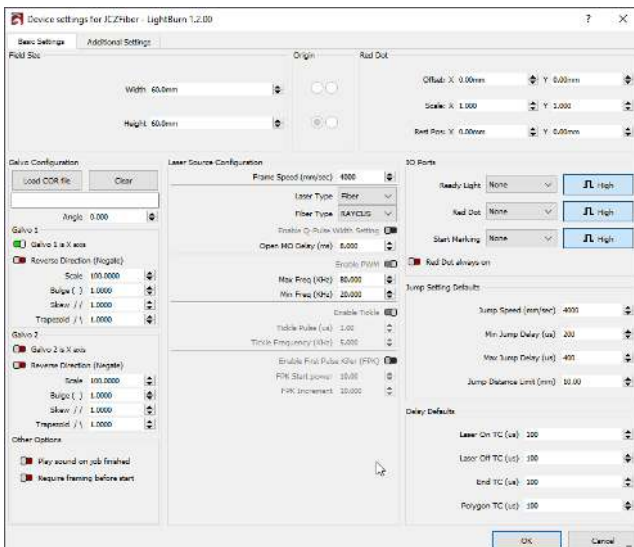



Moves' will prevent this constant retract / plunge behavior, only issuing Z moves when the Z changes. If you know your material is flat, and none of the Z moves will position the laser low enough to run into anything on your work table, this can save a lot of time.

#### SCANNING OFFSET ADJUSTMENT

Scanning offset is useful when doing raster or vector scanning at high enough speeds that delays in your power supply cause the firing point to be a little behind where it should be. See the help for [Scanning Offset Adjustment here](#).

The `Add`, `Delete`, `Import` and `Export` buttons allow you to create, edit, and manually import & export your scanning adjustments with user users, or explicitly make a backup before making changes.

#### OTHER OPTIONS

Note that this section will appear differently depending on the type of controller you have, and not all settings will appear for all controllers.

##### Fast Whitespace Scan

When engraving an image, LightBurn normally moves at the same speed across the entire image. If you are engraving slowly to get a good burn, but the image contains a lot of empty space (white space), this takes a long time. With the Fast Whitespace switch enabled, LightBurn will boost the speed through blank areas to the speed you indicate, if it is faster than the current engraving speed. This can save significant time.

#### Note

Since Marlin treats G0 and G1 moves identically, this value is used to specify the speed for rapid moves. If you do not set this value, LightBurn will use the same speed as the G1 moves.

##### Enable \$J Jogging

On newer versions of GRBL (1.1 and later) \$J is a custom jogging mode that has several benefits over normal jogging, which just sends simple G0 or G1 moves. The new jog format does not affect the GCode parser state, and if soft limits are enabled, any jog command that would go out of bounds is simply ignored, without triggering an error or alarm.

This setting also allows cancelling a jog move, which LightBurn uses for Continuous Jog - You press and hold a move arrow to begin jogging in a direction, then release the button to stop (cancel) the jog move. Continuous Jogging is enabled in the [Move Window](#). The switch to enable Continuous Jogging will not appear unless \$J jogging is enabled.

##### Enable DTR signal

Standard serial ports have a pin (Data Terminal Ready, or DTR) that the host enables to tell modems that software is ready to receive data, and some devices require this signal to begin communication. Many programmable hobby-level controllers, like Arduino based systems, use the DTR pin to

reset the controller. LightBurn usually sets this value for you, but if you find your GCode controller won't communicate, toggling this setting *might* help.

##### Use G0 moves for overscan

By default, all scanning moves emitted by LightBurn are G1 moves, where only the power value is varied, for consistent speed and power output. Some controllers, like FabCreator Smoothieware boards, have a non-zero power value for their minimum output, and can end up burning during the overscan portion of an engraving. Turn on this setting to use G0 moves for overscan to eliminate this.

##### Enable laser fire button

Diode lasers often don't have a red-dot pointer like CO<sub>2</sub> lasers do, so it is often useful to enable them at low power for focusing or framing. (Please do NOT do this if you have a CO<sub>2</sub> laser, as the beam is invisible and this could blind you or start a fire). Turning on this setting will enable a button and a power setting on the [Move Window](#) that allows you to turn on the laser at low power for focusing and positioning.

When the 'Fire' button is enabled, you can hold the Shift key when framing to enable the beam.

##### Laser on when framing

This triggers the active laser to run when running the "Frame" operation on DSP & GCode based devices. This is useful as a test button.

#### Danger

This will use the laser's tube when otherwise a user may not have been expecting this behavior. Use caution when changing this setting.

##### Enable Out of Bounds warning

DSP controllers automatically check for out-of-bounds conditions, but GCode controllers do not have advance knowledge of the data being run, and therefore can't do this. Enabling this flag will tell LightBurn to warn you if a job will cause your system to travel out of bounds. Note that this requires your system to have been properly homed, reporting coordinates correctly, and with the workspace size set properly.

##### Return to Finish Position

When running jobs in 'Absolute Coords' or 'User Origin' mode, enabling this flag tells LightBurn to send the laser to the specified position after a job is run. This is a convenience to move the laser head out of the way for unloading material.

##### S-Value Max

GRBL and Smoothieware use the S-Value (spindle speed setting) to control the PWM power output to the laser. This setting is the number that corresponds to 100% power in LightBurn. Smoothieware typically uses a value from 0 to 1 and supports fractional numbers in between. GRBL defaults to 0 to 1000 for newer versions of GRBL, or 0 to 255 for older ones. The S-Value Max setting in LightBurn must match

your controller setting, or you'll either get not enough power output (if LightBurn's setting is lower) or very small power numbers will set your laser to full power (if LightBurn's setting is higher). The corresponding setting in GRBL is \$30 for the firmware versions that support it.

#### Baud rate

Not all controllers communicate at the same rate. The default in LightBurn for GRBL controllers is 115,200 baud (bits per second), and for Marlin it's 250,000 baud. Some Marlin controllers use 115,200, and some GRBL controllers go as low as 9600. If you are having difficulty getting your controller to communicate, and you're sure the firmware is supported, contact the manufacturer to see if they can tell you the correct baud rate for the board - it might be different than the default.

#### OTHER OPTIONS

Some devices (Ruida) may show an "other options" category of the Device Settings window. In this, you'll find laser 2 controls, file increment options, bounds when framing check, and more.

#### Tab Pulse Width

A configurable width of your tab pulse when using the tab setting in a layer or sub-layer.

#### Enable Job Checklist

This tickbox, and the associated [Edit](#) button, shows the user a text box with a list of items when starting a laser job. This may be useful to remind the user of things like exhaust fans, aligning the origin of a device, and more.

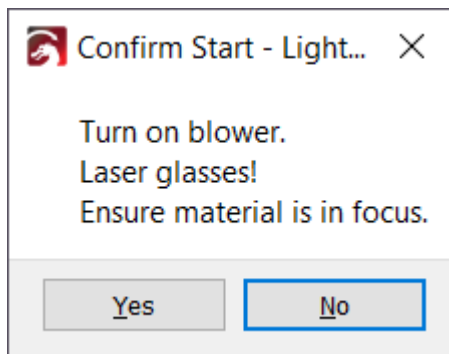

#### Start / End Delay

Start Delay and End Delay allow you to configure the specific offset before the job begins cutting. On some Ruida setups, this permits the exhaust fan to start up / spin down after the job is "done cutting".

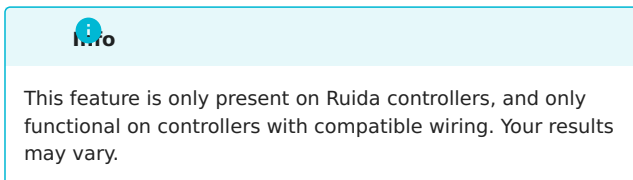

#### ADDITIONAL SETTINGS

The Additional Settings page contains settings used by the preview simulation engine to calculate acceleration timing, traversal speeds, and enforce speed limits when computing the time it will take to complete a job, and when simulating the job. These must currently be set manually by the user to

match your controller settings, though our goal is to handle this automatically if possible.

[Primary Docs](#)   [UI](#)   [Settings](#)

## Machine Settings

Many of the controllers supported by LightBurn have user configurable device parameters and, in many cases, you can edit those parameters directly from the `Machine Settings` dialog in LightBurn. Notable exceptions are Smoothieware and Marlin, which do not currently allow use of the `Machine Settings` dialog.

**While connected to your machine** you can go to `Edit > Machine Settings` and will be presented with the following dialog (sometimes after a brief delay while the parameters are read from the controller):

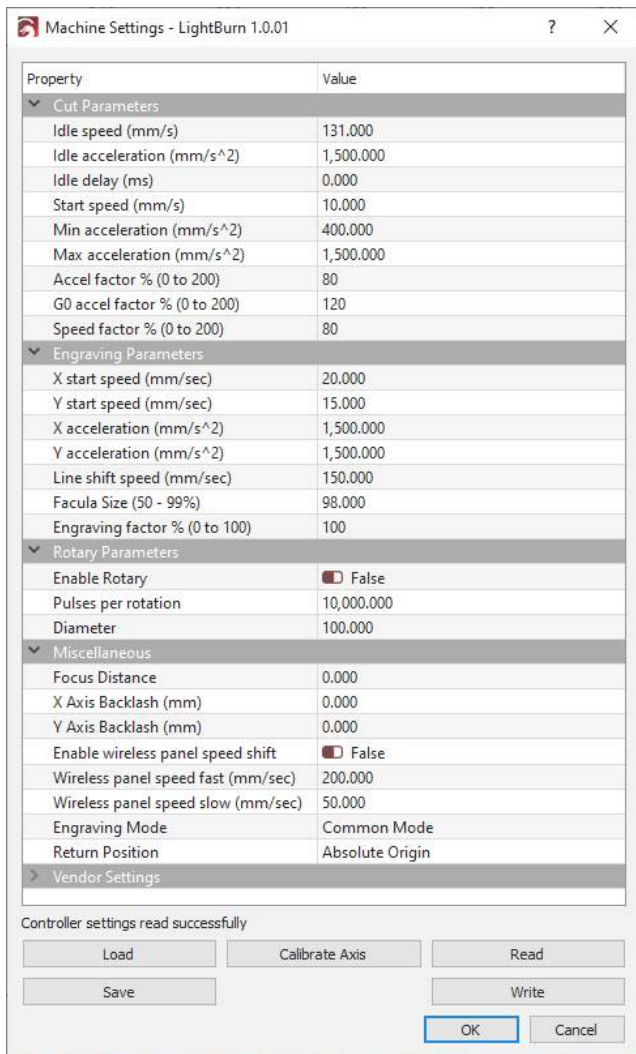

The content of this dialog will be different for every controller type so we won't go through every option and value here. The parameter names are intended to be relatively self-explanatory but if you do not understand what something does, definitely do not just go about changing it. Look in the documentation for your controller or search on the [LightBurn Forums](#) for more info.

We would like to specifically call out the `Vendor Settings` section that will appear for Ruida controllers. These settings

are typically set at the factory where your laser was manufactured or configured and it's best not to touch any of these unless you **really** know what you are doing.

Beyond the parameters that you can change there are five operations that can be taken with the buttons at the bottom of the dialog:

### WRITE

Write all currently modified parameters back to the controller. This **must** be clicked before you close the dialog as the parameters are not sent to the controller as you change them, only after clicking the `Write` button.

### READ

This will reload the settings from the controller. Note that any changes you made will be lost if you have not written them to the controller first.

### SAVE

Save the controller parameters to a `.lbtset` file. This allows you to backup your controller parameters so they can be reloaded later in case of accidental change or loaded on another machine which you would like to be configured in the same way.

### LOAD

Load a `.lbtset` file and overwrite the current controller parameters with its contents. **Warning:** this will overwrite **all** parameters! Be sure to back up what you had first with the `save` option and **only** load parameters from a known and trusted source!

In some cases your laser manufacturer will actually provide this file for you, as a backup.

### CALIBRATE AXIS

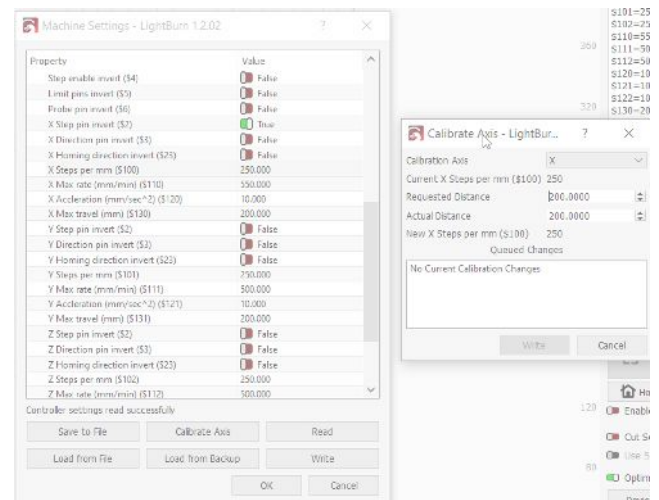

The `Calibrate Axis` tool is provided as a shortcut to getting your machine axis movement distances dialed in and setting the `steps/mm` parameter on your controller. Please note that this is no replacement for knowing the true `steps/mm` value for *your specific machine*. You can read more on our [steps/mm page](#).

To use this tool, you will need to follow these steps:

- Choose an axis to calibrate with the `Calibration Axis` option. This will display the current `steps/mm` setting directly below.
  - Choose a distance you want to move that axis as a test. 200mm, for example. Then enter that in the `Requested Distance` field.
  - Instruct your laser to move that distance. If you cannot do that from a built in control screen, you may have to back out of `Calibrate Axis` and use the jogging functions on the `Move Window` to move the selected distance.
  - Measure the actual distance moved in whatever way is easiest for your particular machine, with the most accurate measurement tool you have. Calipers or a ruler with fine degradations would be best.
- Back in the `Calibrate Axis` dialog, enter the measured value into the `Actual Distance` field. This will show you the newly calculated `steps/mm` value below.
  - Finally, click on the `Write` button to persist this value to the controller.

**Note:** It may require multiple iterations of these steps to dial everything in to an acceptable level of accuracy, especially with less accurate measuring tools. Though, the larger the `Requested Distance` value, the easier it is to measure the difference. Simply repeat the same steps, using the same requested distance each time. The new `steps/mm` value should continue to become more accurate the more times you repeat this process.

## 4.5.3 Tools & Wizards

### Primary Docs Tools

#### LightBurn Tools & Wizards

This is a list of all the standard tools offered in LightBurn to make your projects easier and to edit your designs more directly.

#### IMAGES

- [Image Adjustment](#)
- [Image Tracing](#)
- [Image Masking](#)

#### ALIGNMENT & FIXTURING

- [Center Finder](#)
- [Snapping Tool](#)
- [Docking Tool](#)
- [Cut Shapes](#)

#### EDITING & MEASURING

- [Edit Nodes Tool](#)
- [Measure Tool / Ruler](#)
- [Modifier Tools](#)
- [Two-Point Rotate](#)

#### GENERATORS & VARIABLES

- [Material Test Generator](#)
- [QR Code Creator](#)
- [Variable Text](#)
- [Formatting](#)

### Primary Docs Tools

#### Adjust Image Tool

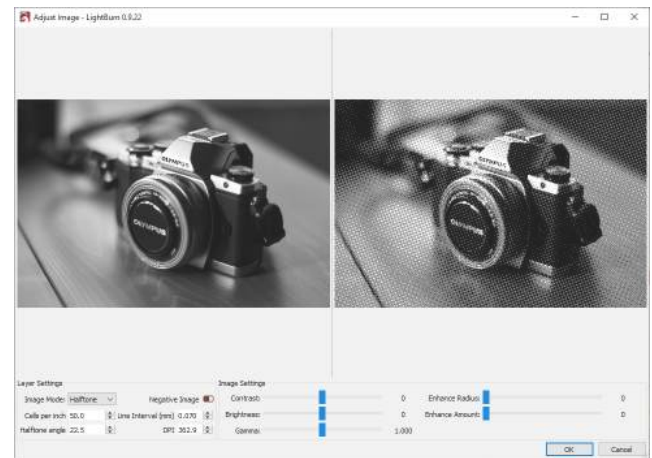

The Adjust Image tool is designed to greatly simplify the process of tweaking image properties such as contrast, brightness, and gamma while also changing the engrave settings. Best of all it allows you to instantly see the results of these changes with both the image properties and engrave settings applied.

The Adjust Image tool can be accessed by selecting any single image, right clicking, and choosing the [Adjust Image](#) option.

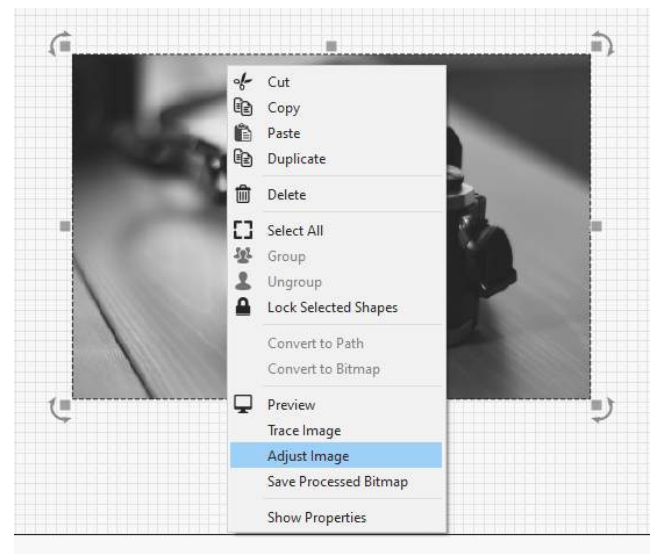

On the top left the original grayscale source image is displayed. On the top right is the processed result of the chosen settings. Just like in the main edit window, you can use the mouse scroll wheel to zoom in and out on the image and clicking and dragging to move the image around. As you can see below, the source image and output image are kept in sync while performing these operations.

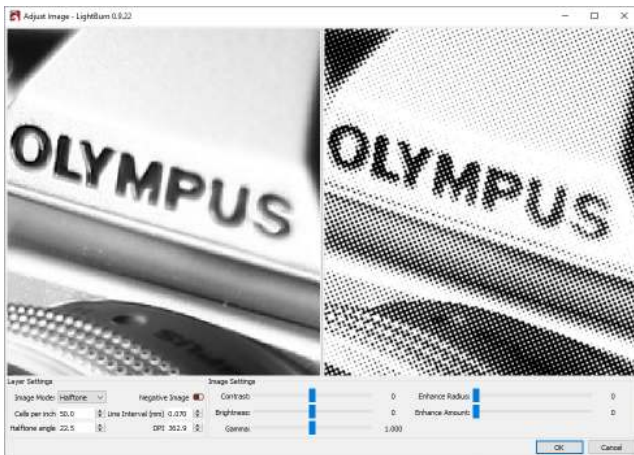

#### LAYER SETTINGS

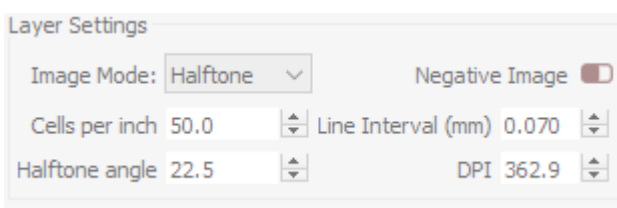

The Layer Settings group on the left contains settings that correspond directly to those found in the [Cut Settings Editor](#), as you can see below:

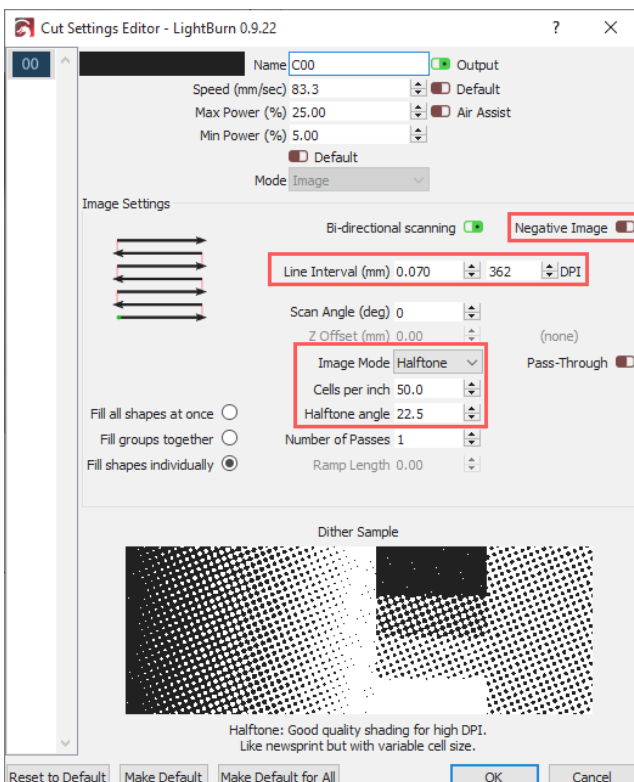

When adjusting an image and changing these settings, it will update those values on the cut layer currently used by the image selected, once you click the OK button. If you click Cancel, nothing will be changed. It should be noted that these settings will affect **any** image on the same layer.

The most important setting here is the "Image Mode" dropdown as it will allow you to choose from the various image processing modes we have. But, more importantly, unlike changing this setting from the Cut Settings Editor, you get to see what that image mode looks like immediately, side-by-side with the source image.

#### IMAGE SETTINGS

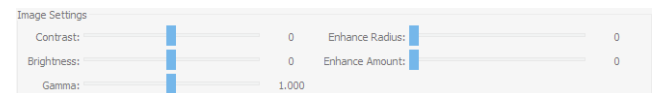

The Image Settings group on the right contains settings that correspond directly to those found in the [Image Shape Properties](#) panel. The only difference being that they are presented as easy to use sliders, so that you can very quickly tweak these values to get the desired result.

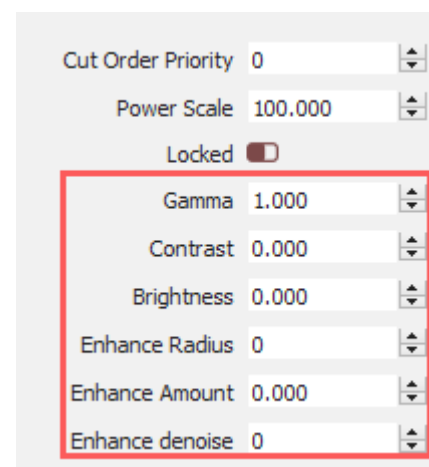

## Tracing Images

LightBurn has a feature that will trace the outline of a bitmap image and convert it to a vector graphic. This works best for content that has very clear edges, like a silhouette or a cartoon. It does not work very well for photographs, though with some cleanup those may be usable as well.

We have an excellent tutorial video for this feature on our YouTube channel here: [Image Tracing Tutorial](#)

To start, import an image object into LightBurn, select it, then choose Tools -> Trace Image from the menu (or press Alt-T). You can also select an image, then right-click and choose Trace Image from the pop-up menu.

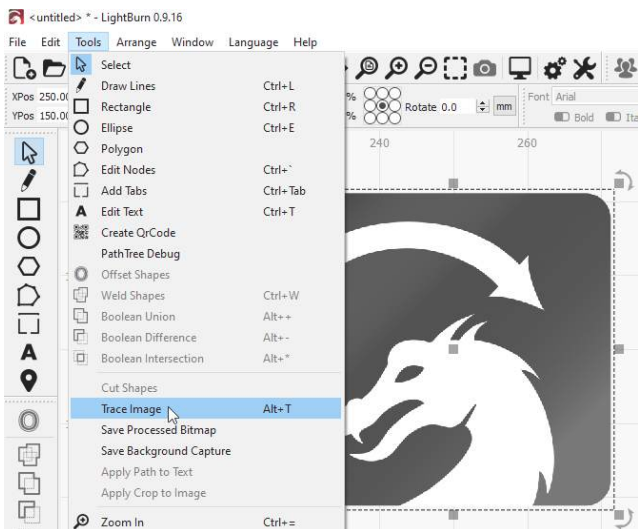

You'll be presented with the Trace Image dialog, with your image showing in the window, like this:

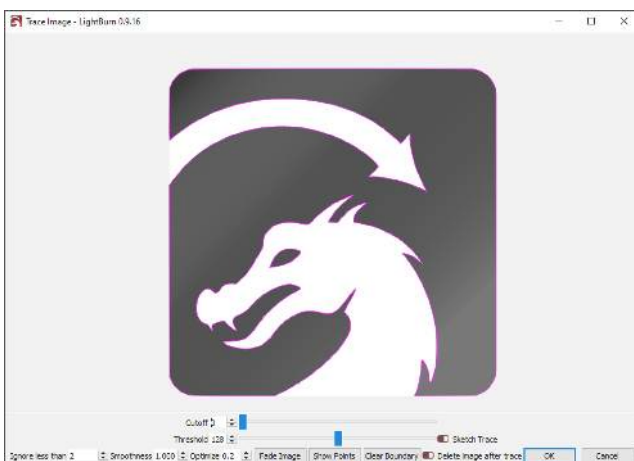

In the image above, the purple lines are the vectors that LightBurn has produced from the image being traced. If you want to be able to see them more clearly, click the "Fade Image" button, and the image will dim. You can also zoom and pan using the same controls as the preview window (mouse wheel to zoom, and click-drag the view with either left or middle mouse).

## Controls

The preview window can be panned and zoomed just like the edit window, using the middle mouse button to pan and the mouse wheel to zoom. Double-clicking the middle mouse button resets the view.

The **Cutoff** slider controls the lower end of the range of values that LightBurn will outline with vectors, and the **Threshold** slider sets the upper end. The default is 0 to 128, which traces around all values in the range of 0 to 128 brightness, excluding lighter values in the range of 129 to 255 brightness.

By adjusting these two controls, it is possible to trace around a narrow range of the image.

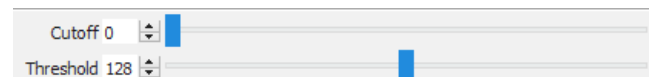

## Selection range

By clicking and dragging within the trace window you can specify a portion of the image you would like to trace. Once the area is defined, you can grab and drag a corner of it to adjust, or just single-click to reset it.

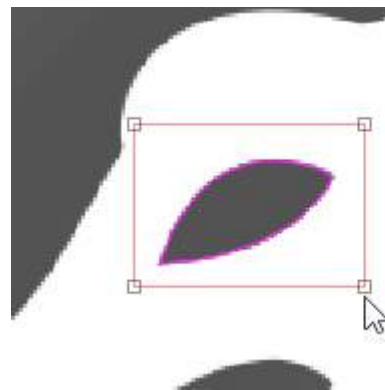

## Ignore less than

This setting tells the vectorizer to ignore anything smaller than this many pixels in area. If you are trying to vectorize a noisy image, increasing this may help.

## Smoothness

Bitmap images are made of pixels, and pixels are rectangles. Image tracing tries to infer shapes from these arrangements of rectangles, and has to smooth out the results or everything would just look like stairs. Part of the process is trying to recover smooth shapes from jagged lines, and this number controls how aggressive the smoothing is. A value of 1.333 is the maximum, and will make almost everything into curves. A value of 0.0 will produce all straight lines. The difference is shown below:

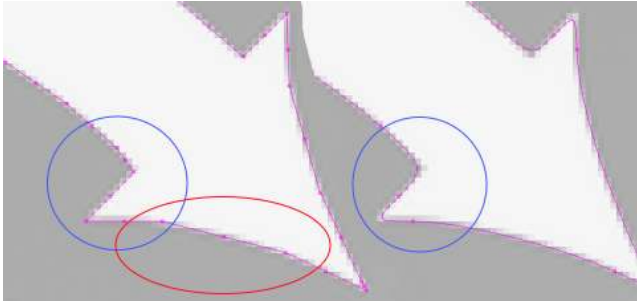

Notice in the left image, with a Smoothness of zero, the area highlighted in red is made of several line segments, whereas the same area in the right image is a continuous curve. The area shown in blue is also sharp in the left image, but with the Smoothness value set to maximum, the image at right shows how even sharp corners become smoothed, and this is rarely desired. The default value of 1.0 is a good mix between producing smooth curves while still maintaining sharp corners.

#### Optimize

After generating lines and curves, the image trace feature will attempt to merge similar lines and curves together to reduce the node count of the result. The Optimize parameter controls how aggressive this is. 0 means no merging. The default of 0.2 is a nice balance between accuracy of the result and node count.

#### Fade Image

Dims the image to make it easier to see the resulting vector shapes

#### Show Points

Enables the display of the points (nodes) of the resulting vector trace. Enabling this is useful when you are tuning the Optimize parameter to see the resulting points.

## Image Masking / Cropping

If you have an image for which you would like to only engrave a portion of that image, you can use the **Image Mask** feature to mask off the area of the image to be engraved. At the simplest this is the same as doing a basic crop to the image, but you can go so much further than that with masking.

### BASIC USAGE

At the simplest this process consists of an image and single, simple shape:

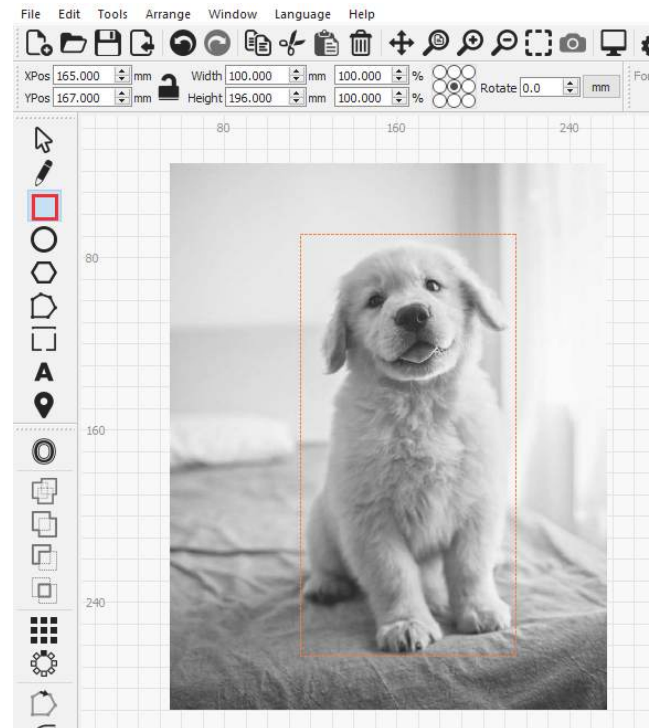

As shown here, the shape is using a **Tool Layer** which can be useful for this process as the masking shape will not also be output. If you also need to cut along the mask then simply use any of the normal tool layers for this process.

Now select both shapes. You can then apply a mask by either selecting **Tools > Apply Mask to Image** or right clicking on the selection and choosing **Apply Mask to Image**.



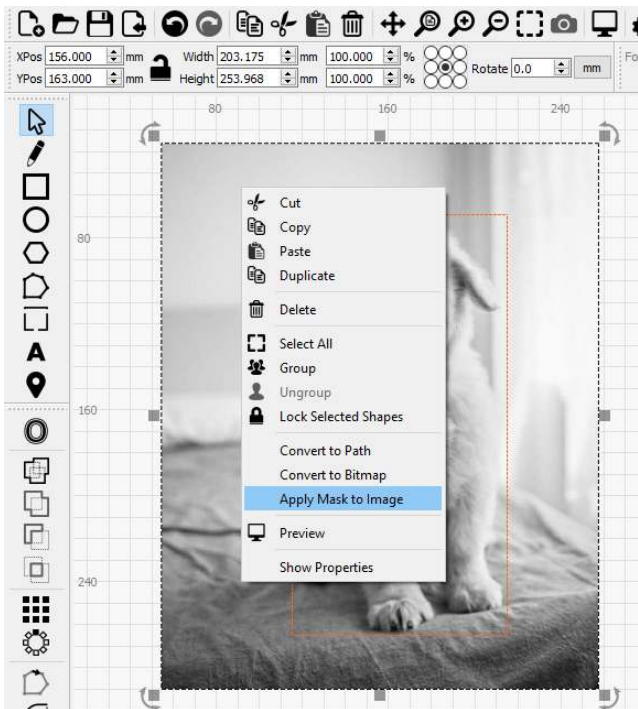

**Note:** You cannot mask using a layer set to Fill, as the filled output would cover the visible image. Any shape you wish to use as a mask must be either a Tool layer, or set to Line mode.

The mask will now be applied to the image as you can see below:

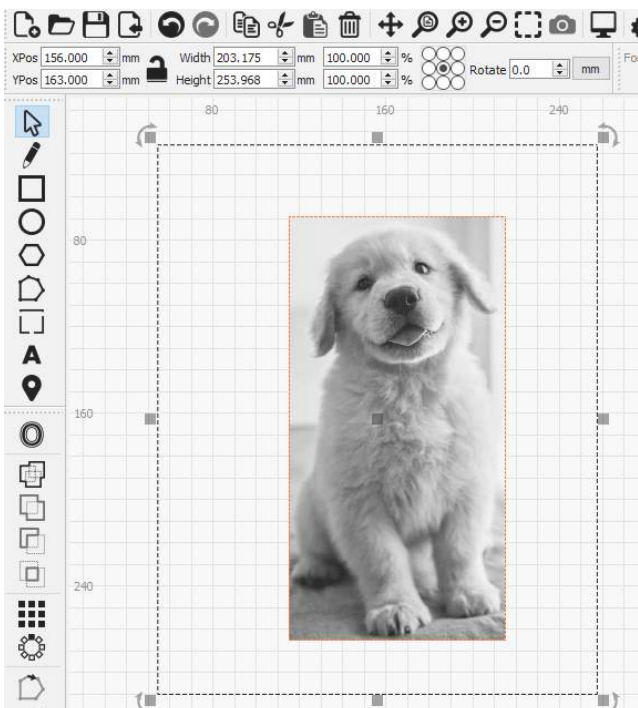

As you can see in the above screenshot, the selection box is still the same size as it was before. This is because the entire image still exists, but the mask is providing a windowed view into that image. If you select just the masking shape or the image, you can move it to reposition the mask.

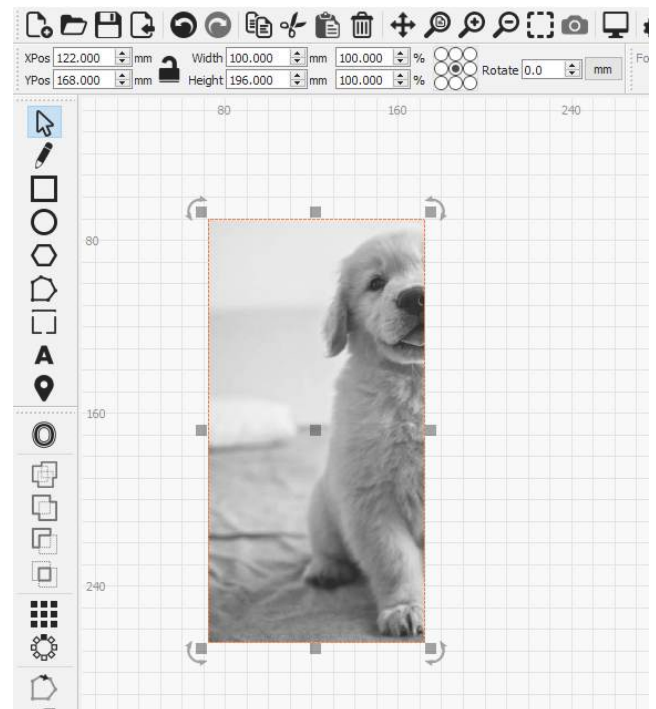

No image data is lost during this process and you can still reposition the image or mask even after saving and reopening a project at a later time. However, as you can see in the preview below, only that part of the image that was masked off will be output:

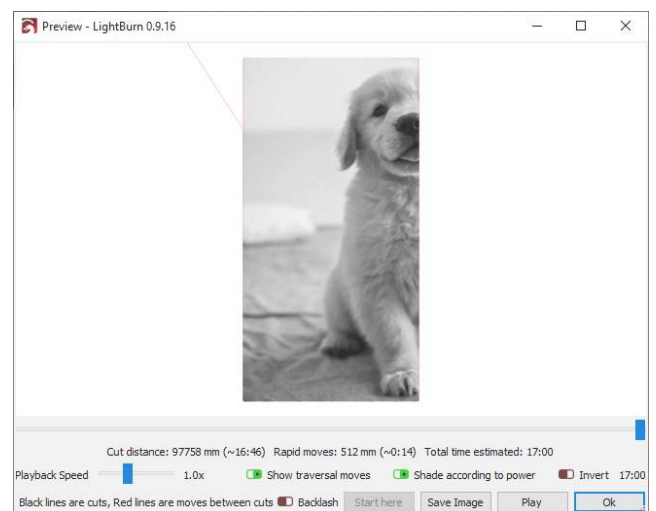

#### ADVANCED USAGE

What we've shown above amounts to merely an advance crop feature but image masking can go much further. For example, you can mask an image using multiple shapes.

#### Note

When using multiple shapes to mask an image, all shapes **must** be on the same cut/tool layer and those shapes **must** be grouped together. Otherwise the **Apply Mask to Image** option will not be available.\_

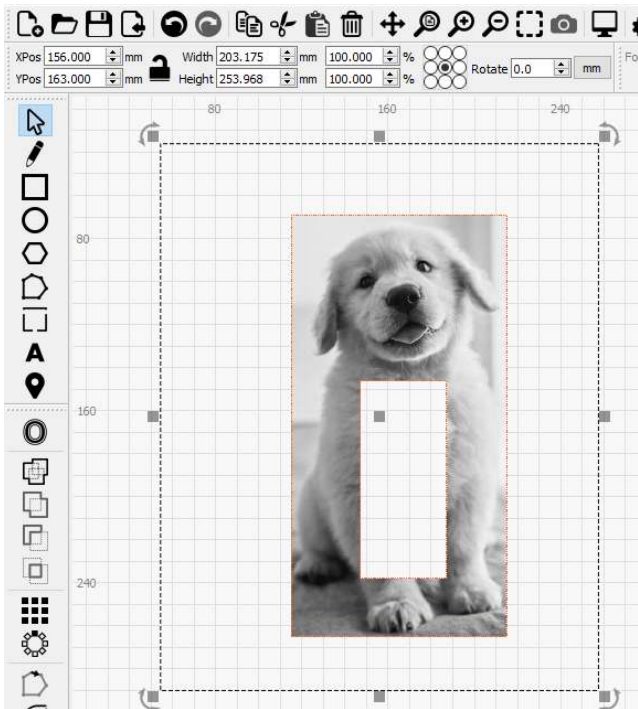

But you can, of course, go far beyond that. Any closed shape can be used as a mask and the easiest way to think about how that mask is applied, is that anywhere LightBurn would normally fill that closed shape in **Fill Mode** will now be "filled" with the image instead. For example:

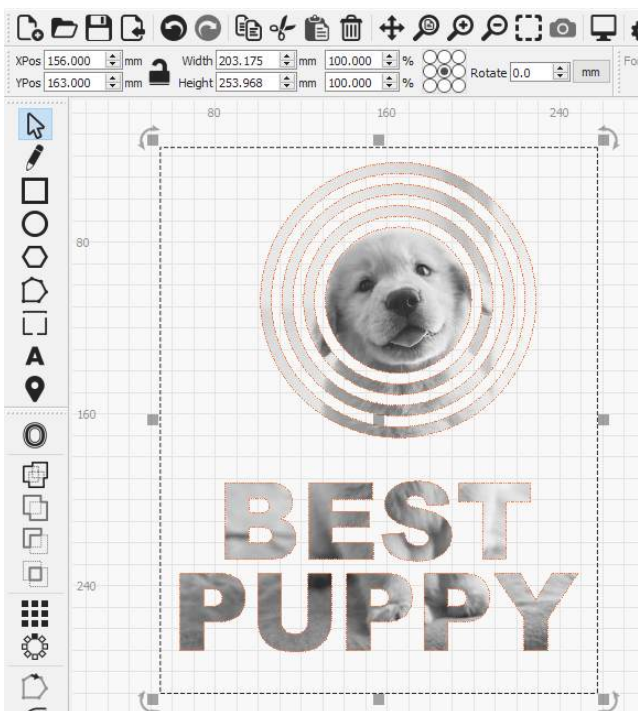

Just remember that you must group together all shapes to be used as a mask first.

#### Removing a Mask

If you would like to remove the masking you can either simply select, then delete the mask shape or shape group,

or you can select the image, right click, and choose **Remove Mask from Image**:

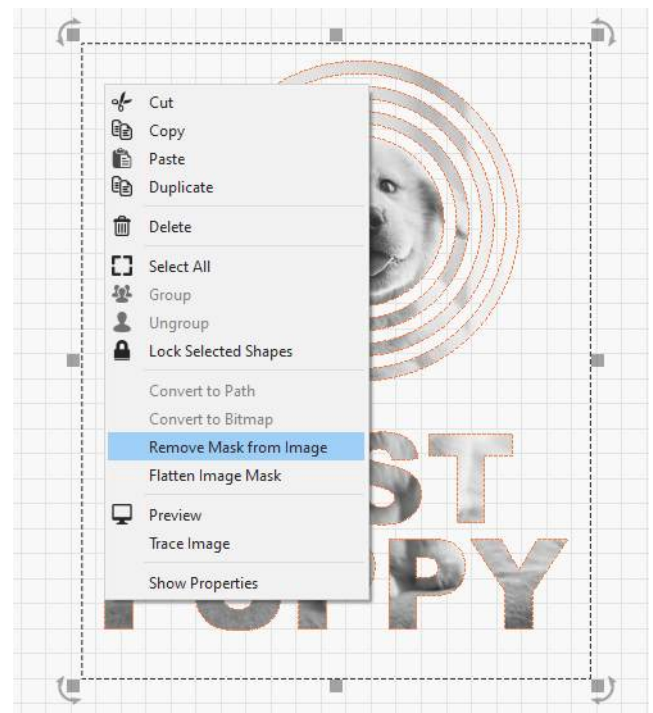

Using the **Remove Mask from Image** option will preserve the mask shape (or shape group) for later use.

#### Flattening a Mask

Finally, if you would like to "bake in" an image mask, you can select the image, right click and choose **Flatten Image Mask**. This will make the mask permanent, actually removing the now unused image data as well as deleting the image mask shape. As you can see below, the selection box is now smaller and the mask shape is now gone:



Primary Docs    Tools

### Circle Center Finder

The Center Finder tool is found in the Laser Tools menu. It is useful for finding the center of circular stock, as well as defining that stock in the LightBurn workspace.

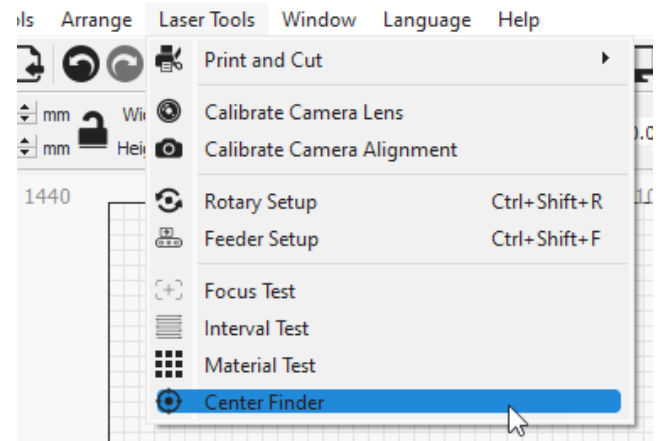

#### Getting Started

- Home the machine.
- If your machine does not have home switches make sure to start the machine with the laser head at the 0,0 point of your work space (Typically lower left corner for g-code machines)
- If the stock you are referencing is light or can be moved easily make sure to secure it somehow so it does not get bumped during the operations.

#### Setting the Points

##### Point 1

Jog the laser head to the first position on the edge of your circle, as shown in the wizard.

**Note - You must JOG the laser with the laser control panel or from the **Move** tab for Center Finder to work.**

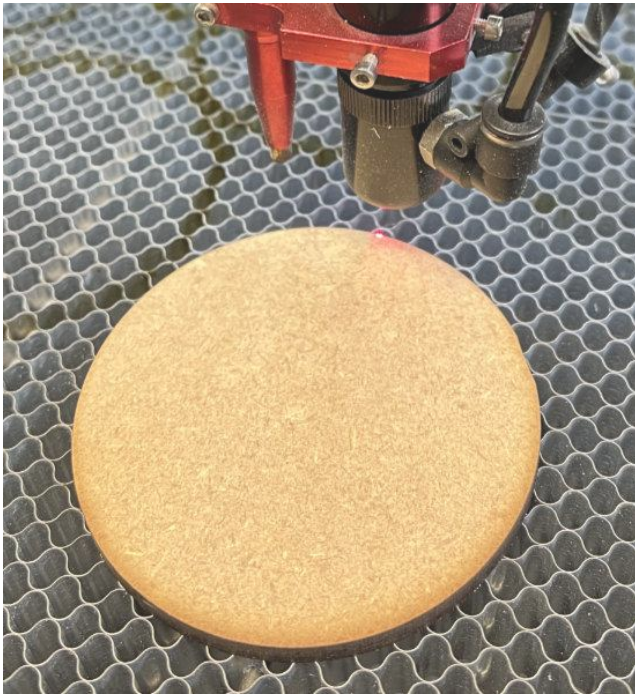
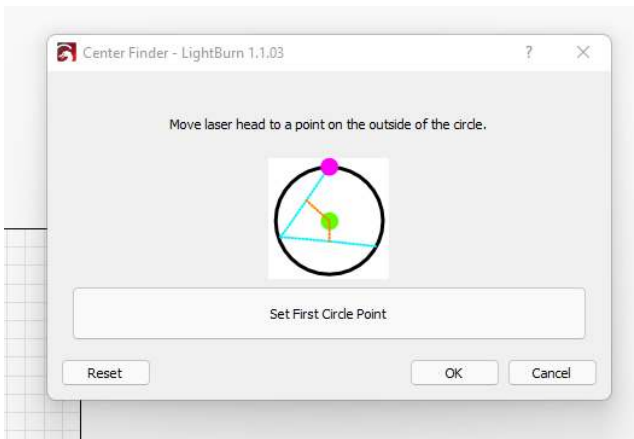

Point 2

Jog the laser head to the next position on the edge of your circle, as shown in the wizard.

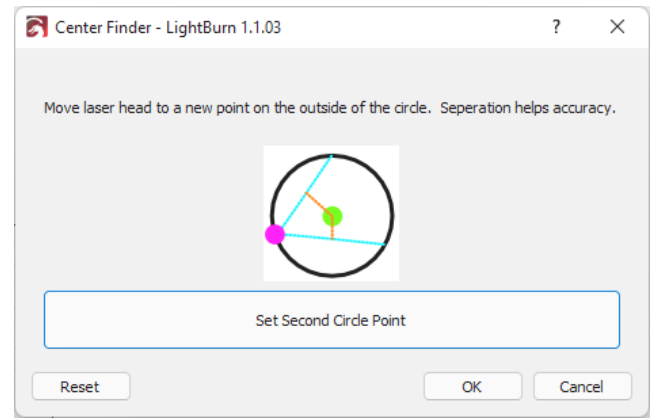

Point 3

Jog the laser head to the last position on the edge of your circle, as shown in the wizard.

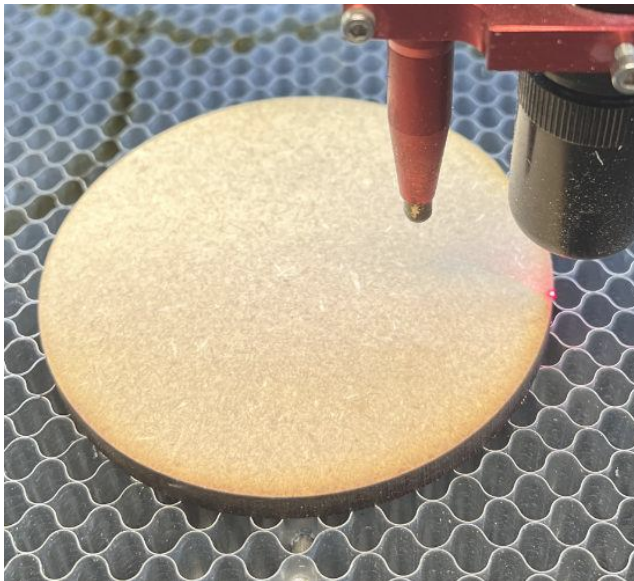
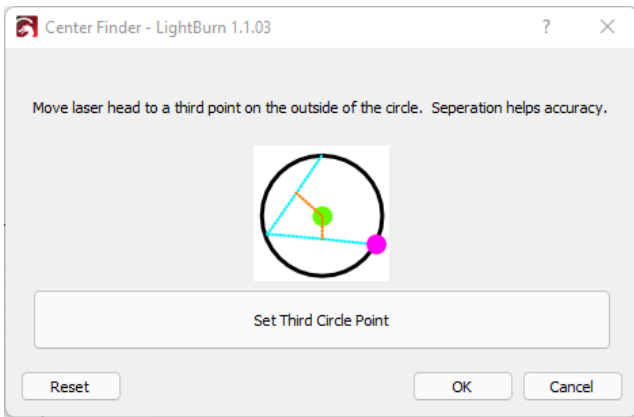

**Move to Center**

The last step will show you the calculated center of your circle and allow you to jog to that point.

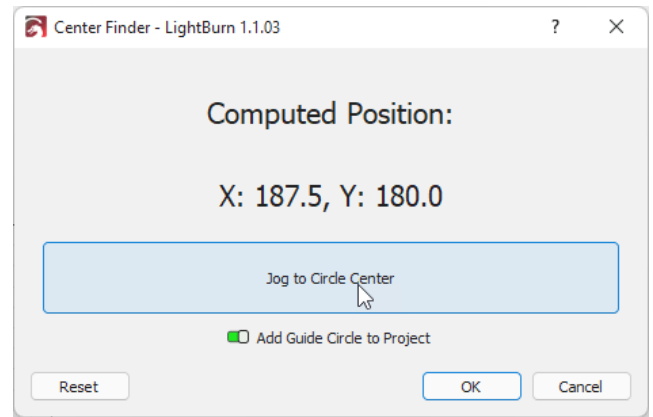

It will also allow you to create a "Guide Circle" on Tool Layer 1 that will give you a representations of your stock in the workspace.

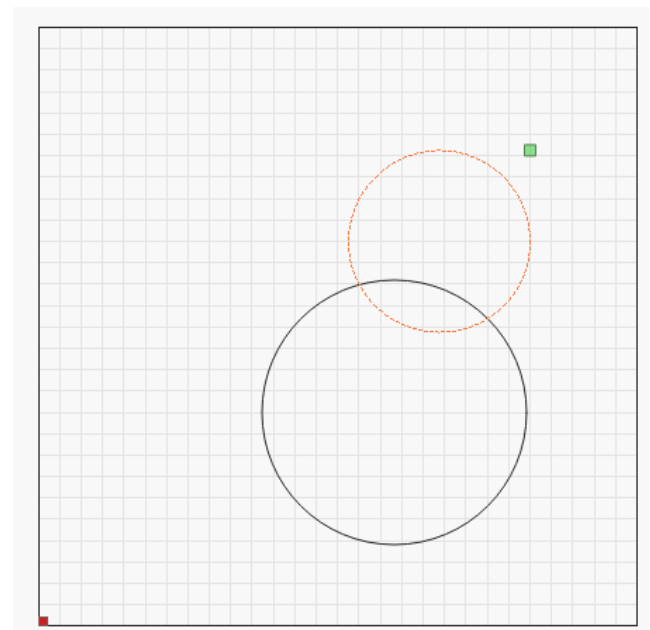

**Setting Origin**

**Absolute Origin**

If you use "Absolute Origin" for your workflow, move your design to the guide circle, and make sure your "Start From:" point is set to "Absolute Coords"

**User Origin - Center**

If you use "User Origin" for your workflow, make sure the center radio button is clicked.

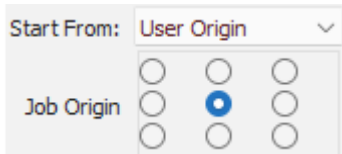

After you move the laser to the center of your work press the "Origin" button on your DSP control panel or the "Set Origin" Button on the Move tab.

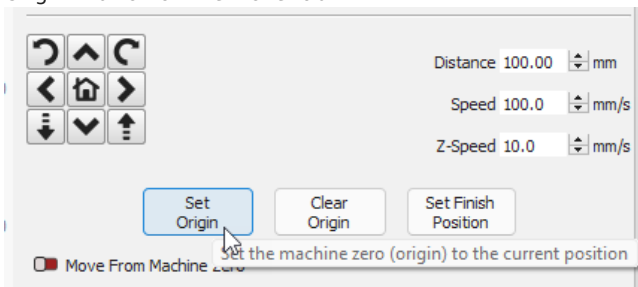

**Notes**

- The more on accurate your point placement is, the better. If you have a red dor laser that is accurate, one trick is to try to split the dot on the edges of your stock.
- You can set the points in any order. The guide is just a helpful reference.
- This tool can find the center of any shape that can be "described" with a circle diameter.

**Shapes like Squares (pick 3 corners)**

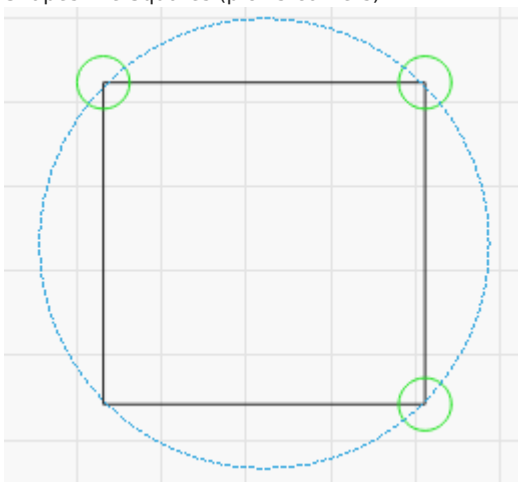

**Equilateral Triangles**

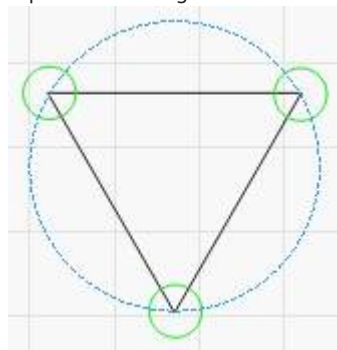

**Hexagons**

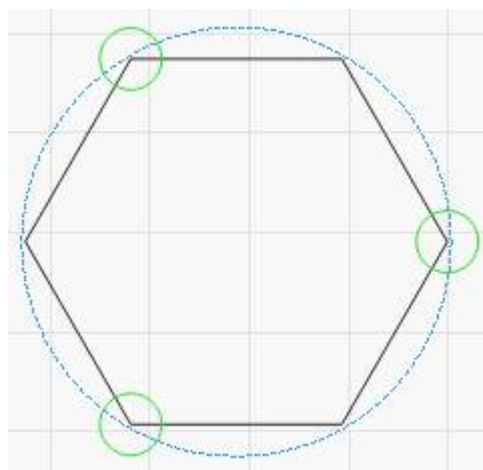

**Troubleshooting**

- **Set a Point Wrong** - Hit the "Reset" Button. This will clear ALL points saved. Just start from the current point. You can set the points in any order.
- **Unable to query the current position of the laser** - This happens when Lightburn is unable to get the position of the laser from the control. Often the laser is still moving, or another command is still in process. Click ok, and try again after waiting for a few seconds. If it continues happening make sure the control is still connected and is showing "Ready" at the top of the "Laser" Tab.

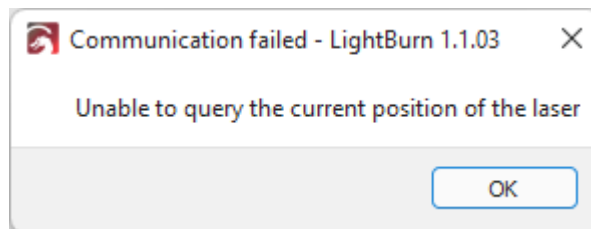

- **Not enough seperation between points** - You have not moved the laser away from the last point or not far enough to make a good calculation. Try moving farther away and set the point again.

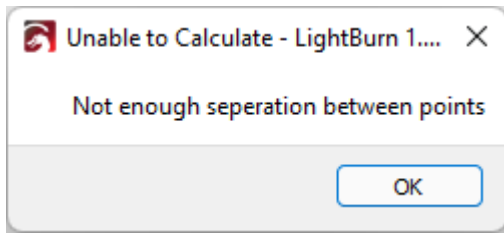

- **Unable to Calculate Center** - Lightburn can't calculate center, or it would be outside your workspace. This typically happens on machines without home switches and that were not started properly. Restart your machine with the head at your machine origin and try to run the wizard again.

### Snapping Tool

When moving objects around the work area, you may notice that on certain points your cursor changes to a different icon. This allows you to use that point to snap a moving shape to another.

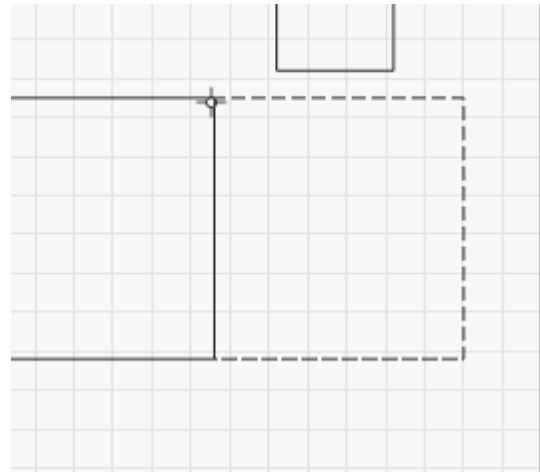

### SNAPPING BEHAVIORS

LightBurn will automatically align your selection to snapping points if you see the cursor change to a snap cursor before you click:

- The selection will snap to a point
- The selection will snap to a line
- The selection will snap to the midpoint of a line
- The selection will snap to the center of an object

Hold Ctrl/⌘ to toggle object snapping (Disable by default, may be enable if **Settings** were changed).

Hold Alt to make snapping 'stickier' - you can snap to things from farther away.

Primary Docs Tools

**Docking Tool**

The Docking tool can be used to bring your objects closer together in your workspace, to allow for more efficient use of your space.

Each of the Docking buttons will tell your selected objects to move in that direction, until they hit something.

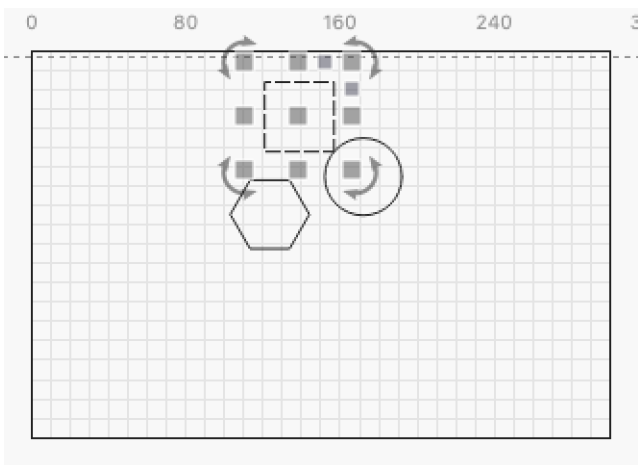
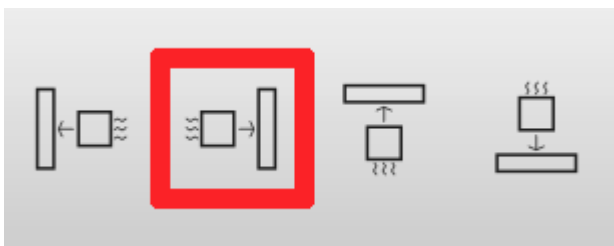
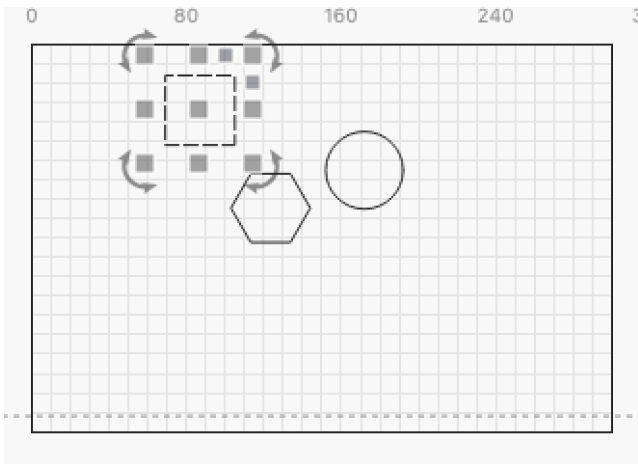

By default, the Docking tool will move all selected objects, as far as they will go.

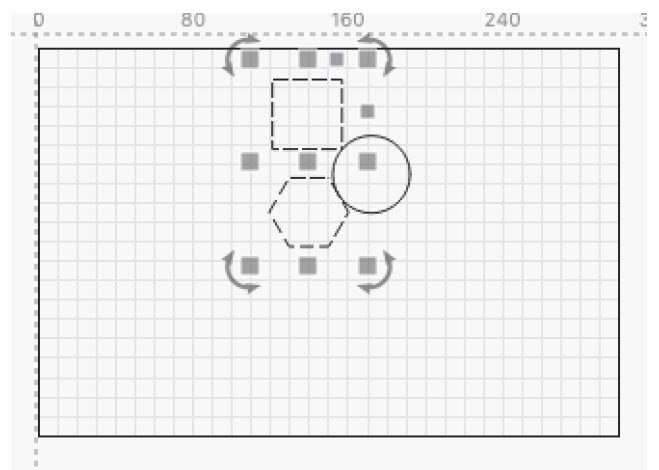
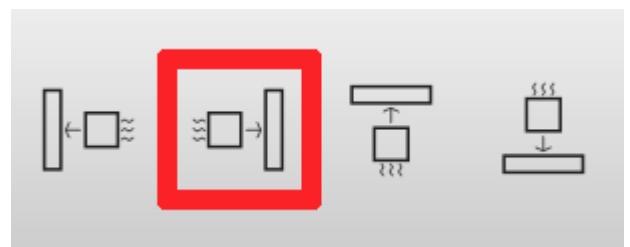
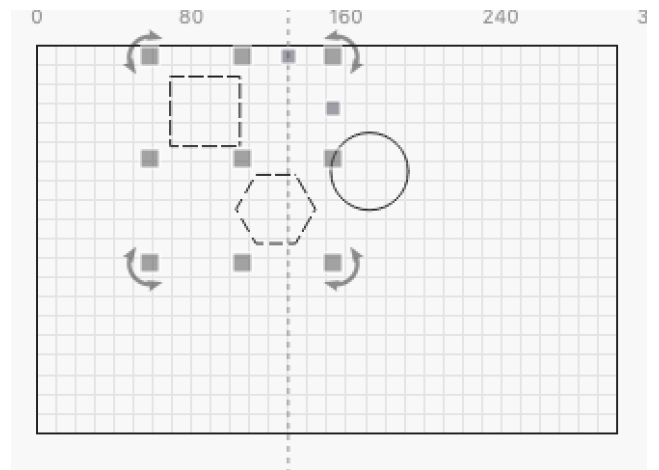

If no other objects are hit, the edge of the workspace will be used.

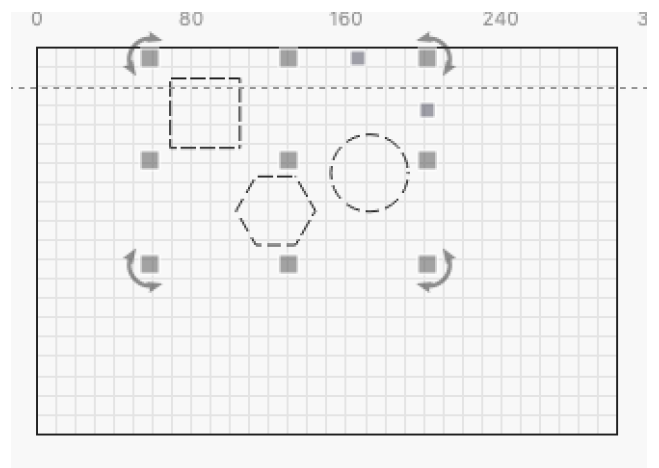



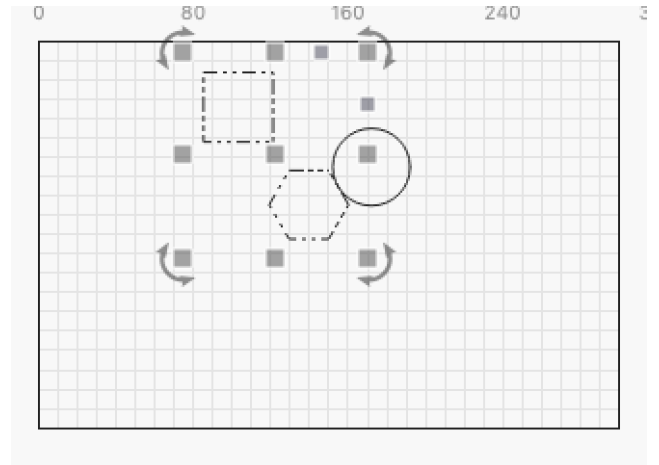
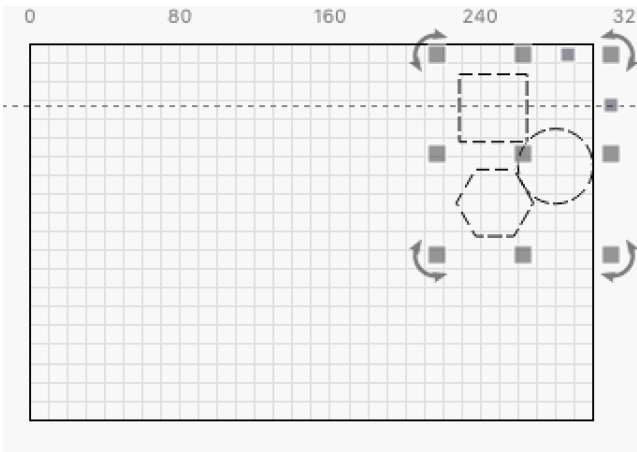
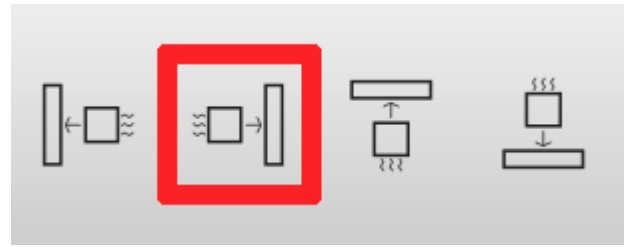
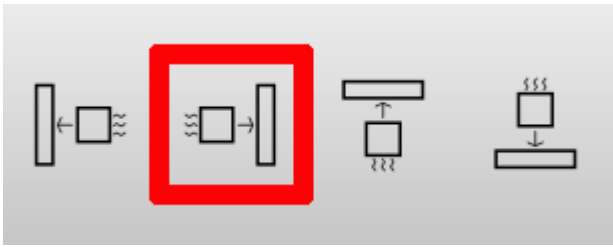

Grouped objects will move together, so if any of them stop, the whole group will stop.

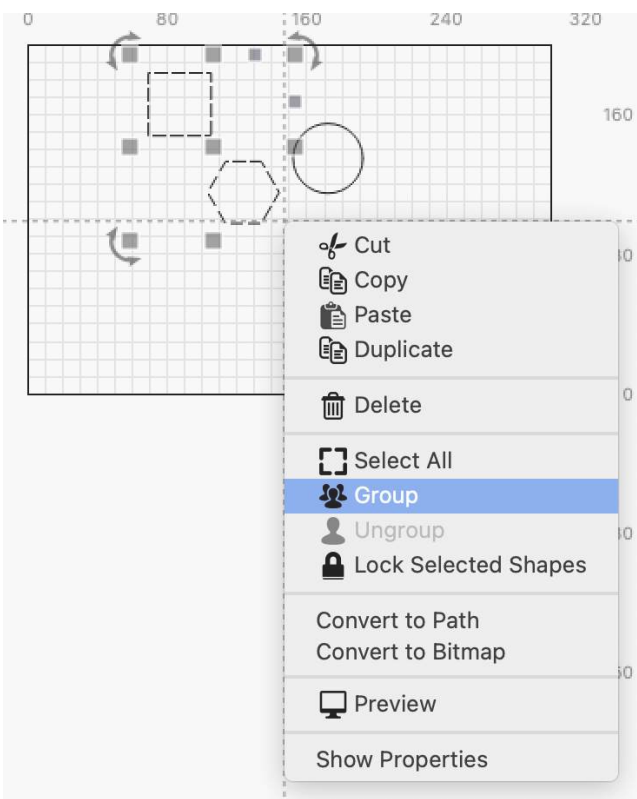

**ADDITIONAL OPTIONS**

The Docking tool comes with a few extra features to change how it works. These options can be found next to the Docking buttons:

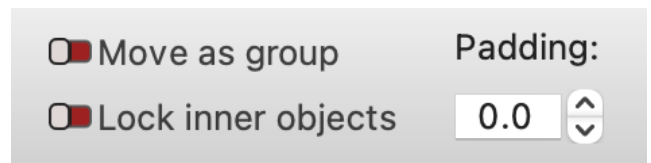

**Move as group**

The **Move as group** setting treats separate objects as if they were grouped.

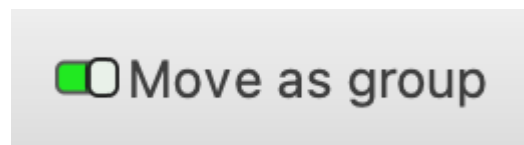

This means that they will only move until one of the objects stops, and the rest of the selected objects will also stop.

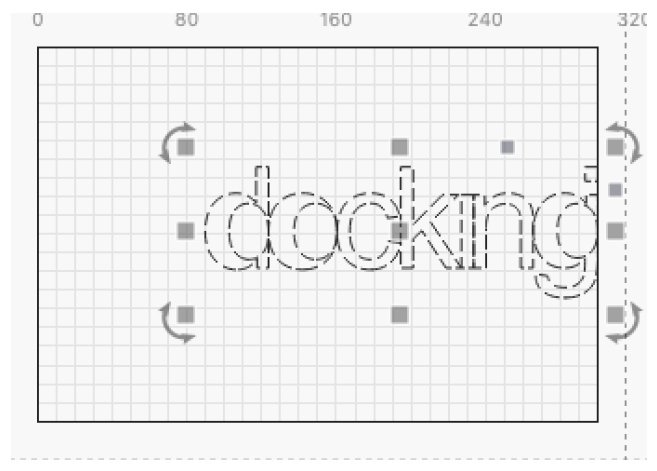
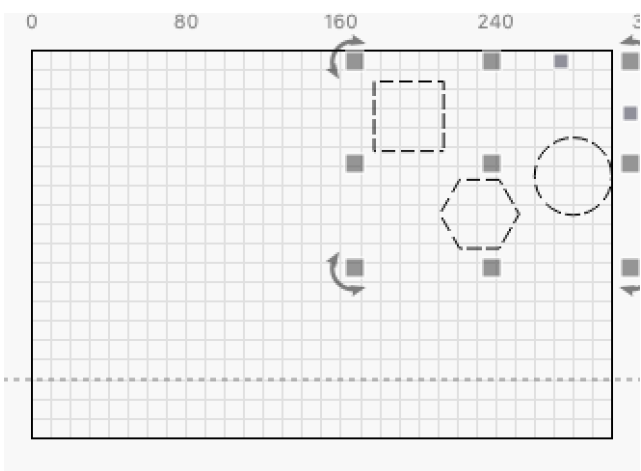
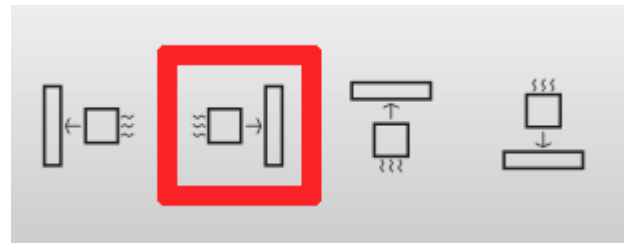
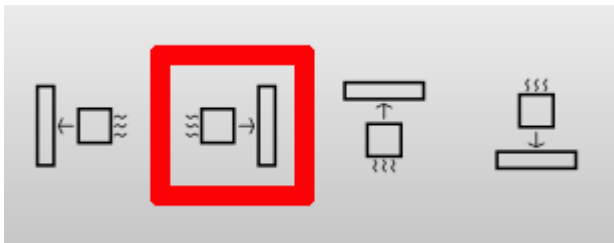
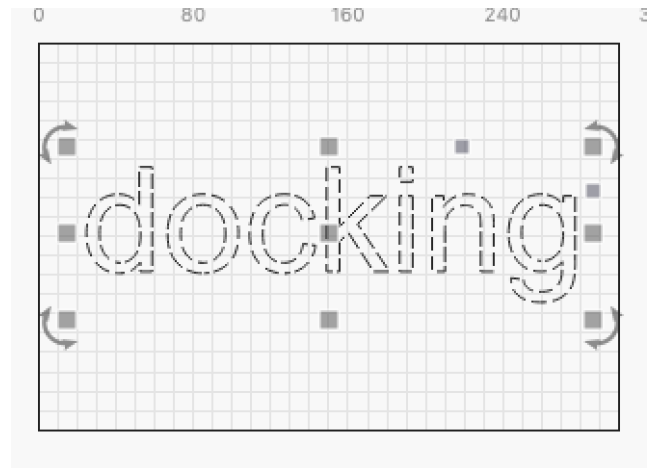
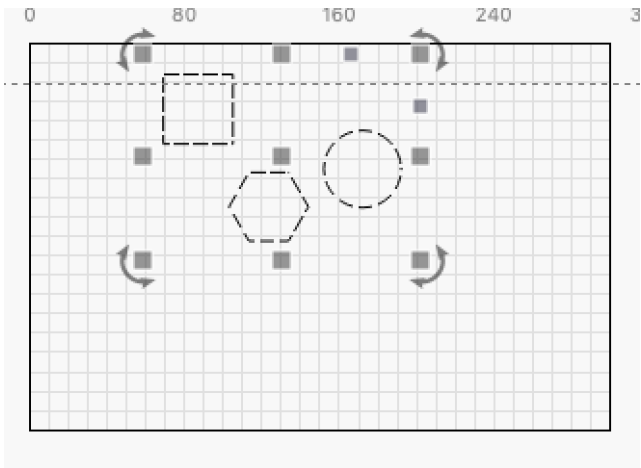

**Lock inner objects**

The **Lock inner objects** setting keeps objects inside other objects together.

When this setting is Off, the inner objects will continue to move, even when the outer object has stopped.

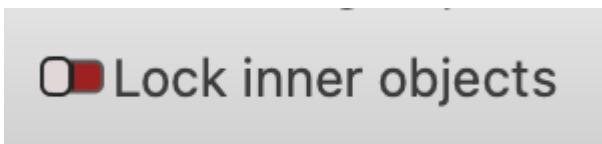

When turned on, the setting will keep the inner objects with the surrounding object.

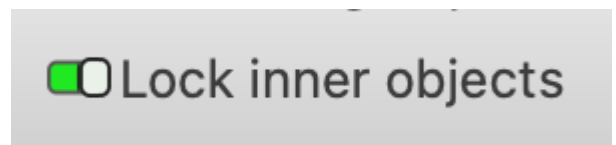

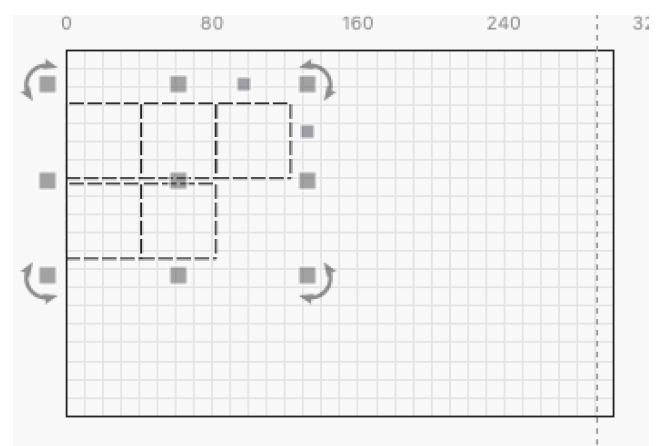
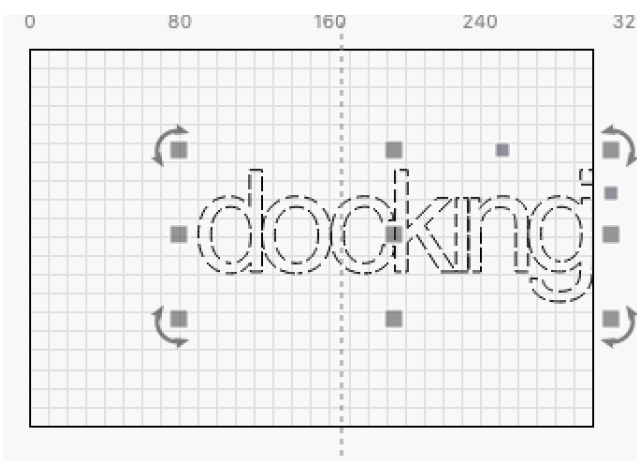
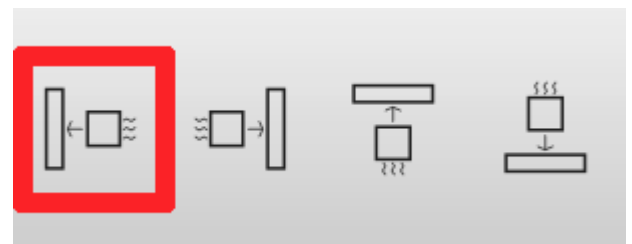
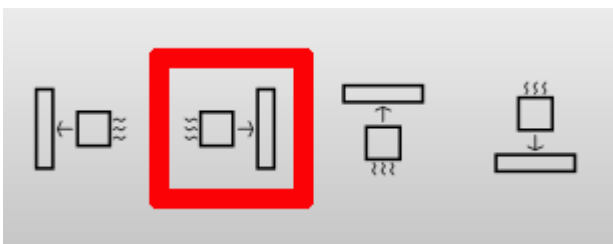
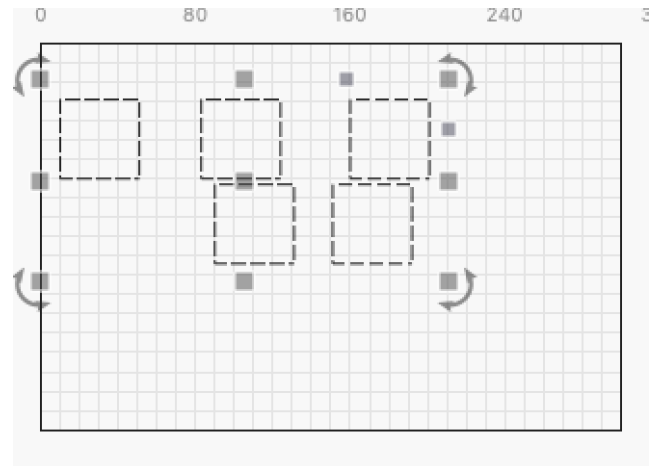
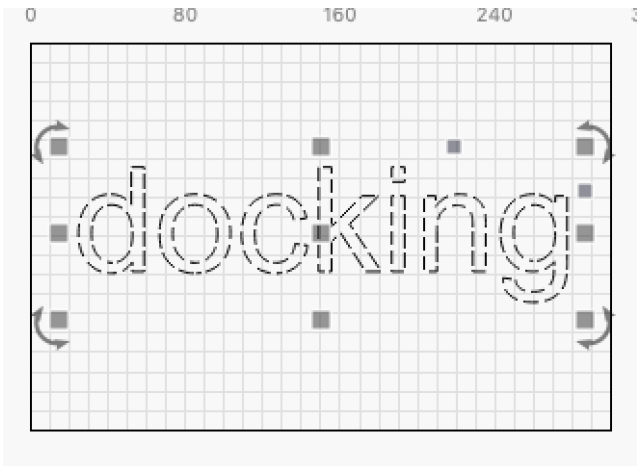

Note that this does not affect objects *that are overlapping*; in this case, the objects will each move independently, finding their own object to dock against (unless you use the `Move as Group` option above).

By increasing this value, you can have objects leave some space when they meet.

**Padding**

The `Padding` setting allows you to specify a distance that will be maintained between objects that are docked.

By default, this value is 0.0, which means that objects will dock right against each other.

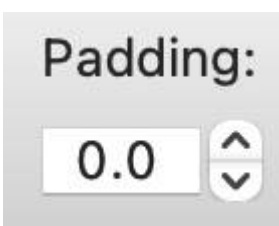

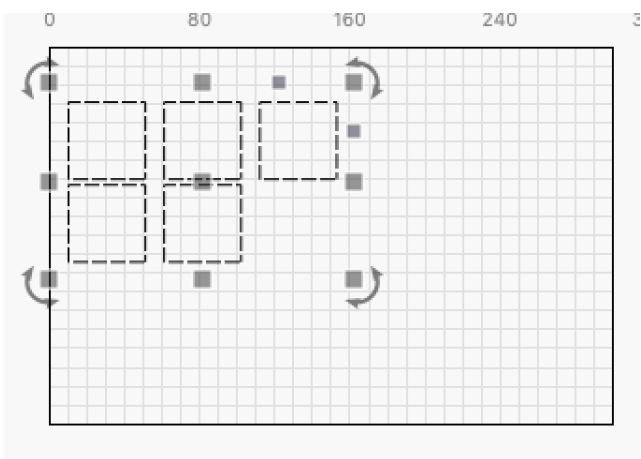
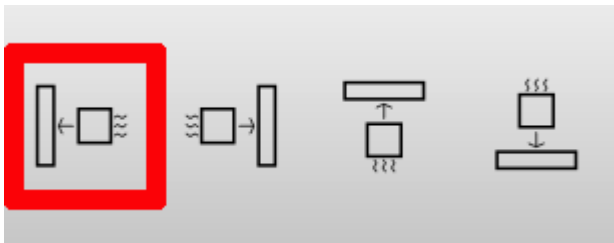
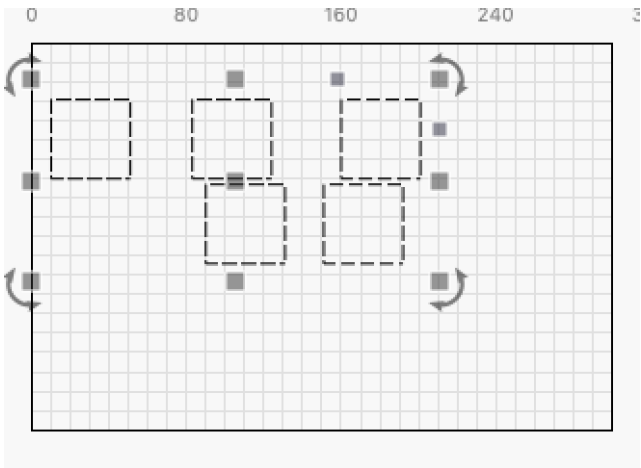

Note that the Padding is only applied in the direction the objects are docking - it won't be enforced in the other directions.

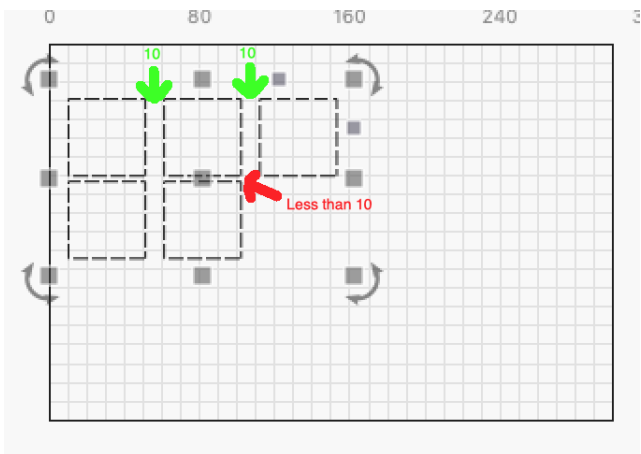

You can fix that extra padding by moving the objects away, then back:

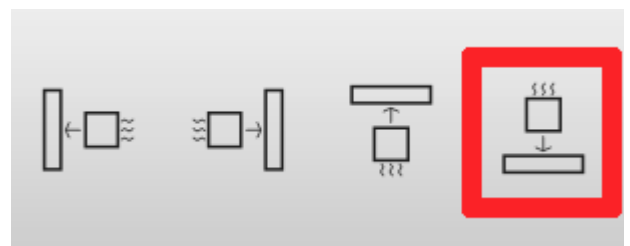
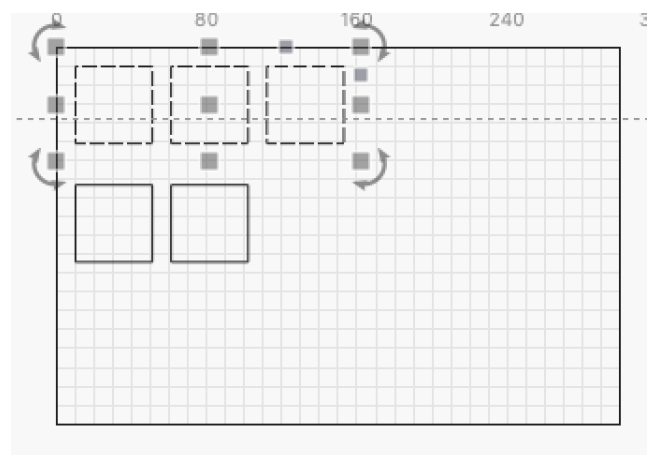
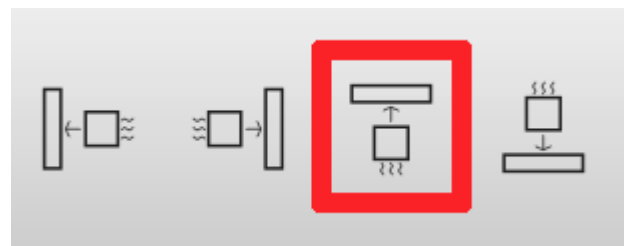
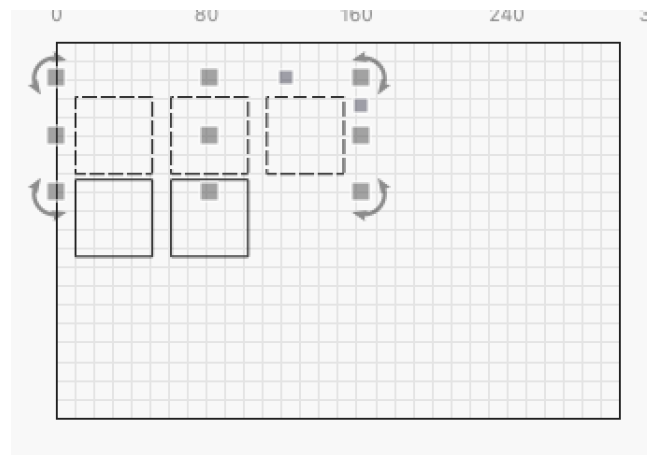

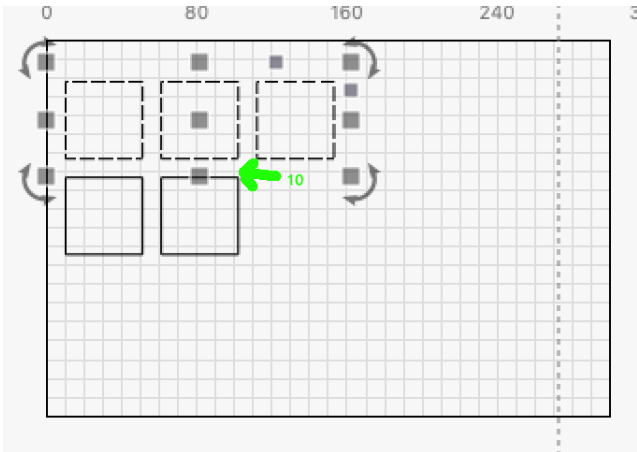

The units for the Padding tool (in / mm) are the same as other tools, such as the Numeric Edits tool.



### Edit Nodes Tool

The Edit Nodes tool allows you to edit the nodes, lines, and curves that make up a shape in LightBurn. Note that built-in primitives in LightBurn, like Text, Ellipses and Rectangles, cannot be edited without converting them to a generic path object first using **Convert to Path**.

#### NODE EDIT

Action	Windows / Linux	macOS	Notes
Smooth corner node	S	S	while hovering over a node
Convert line to smooth curve	S	S	while hovering over a line
Convert curve to line	L	L	while hovering over a curve
Convert smooth node to corner	C	C	while hovering over a node
Delete node	D	D	while hovering over a node
Delete line	D	D	while hovering over a line
Insert node point	I	I	while hovering over a line or curve
Insert node at midpoint	M	M	while hovering over a line or curve
Break shape at point	B	B	while hovering over a point
Trim line	T	T	while hovering over a line, trim line under mouse at next intersection
Extend line	E	E	while hovering

Action	Windows / Linux	macOS	Notes
			over a point, extend line from point under mouse to intersection with another shape

[Video Tutorial: Trim and Extend](#)

**SNAPPING**

Note that in all of the above tools, when creating a new shape, you will occasionally see the cursor change if you hover over a point on an existing shape. This means LightBurn is going to snap what you're about to make to that point. You can bypass this behavior by pressing the Ctrl key (Command on MacOS). LightBurn will snap to object centers, end points of lines or curves, or center point of lines or curves, in addition to just snapping to the grid.

**PATHS AND SHAPES - CONVERT TO PATH**

In LightBurn, all vector objects are stored as paths - a series of points connected by lines or curves. If you use the **Draw Lines** tool, you are directly creating what LightBurn calls a Path shape. Path shapes are the "lowest level" thing you can make in LightBurn.



Rectangles, Circles, Polygons, and Text shapes are different - They store the information used to build the path, and if any of that information changes, the path is discarded and re-built from scratch.

For example, Rectangle shapes know their Width, Height, and whether the corners have a radius. If you edit the 'Corner Radius' property on a rectangle shape, the path that LightBurn has built is thrown away, and a new one with the new radius is created. Similarly, if you change the font applied to a text shape, the old version of it is discarded and a new one is built using the new font.

If you want to node edit a shape, it has to be a path shape - using the Convert to Path function in LightBurn on a built-in shape type tells LightBurn to turn it into an editable thing that is just points and curves, and that it's ok to throw away the information about the original type of thing it was.

**Primary Docs Tools**

**Measure Tool** 

With the measurement tool you can view a wide array of useful information about any shape object. To use this tool, click on the icon in the **Creation Tools** toolbar. (  Alt +  M )



It will display the following dialog:

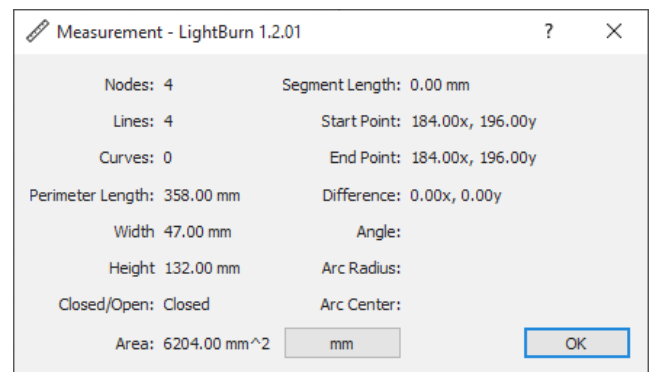

As you hover the cursor over shapes, it will highlight any individual shape in green and the line or curve segment the cursor is currently over in purple, as you can see below:

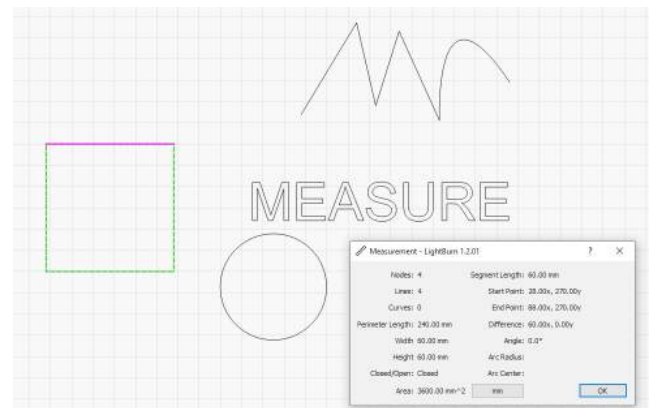

The values show in the measurement dialog are as follows:

- **Nodes:** Number of vertices (beginning or ending points of line/curve segments) in the shape.
- **Lines:** Number of straight lines in the shape.
- **Curves:** Number of arcs or bezier curves in the shape.
- **Perimeter Length:** Total length of all line/curve segments in the shape.
- **Closed/Open:** Whether or not the shape is closed. Defined as all line/curve segments beginning and ending on nodes shared with another line/curve segment.
- **Area:** The total area of the shape. Value is empty if shape is not closed.

- **Segment Length:** Length of the line/curve segment currently highlighted in purple.
- **Start Point:** X,Y coordinate of the start node of the currently highlighted line/curve segment.
- **End Point:** X,Y coordinate of the end node of the currently highlighted line/curve segment.
- **Difference:** End Point values minus the Start Point Values
- **Angle:** Angle of the line between the start and end points. In the case of regular line segments this is the angle of the line itself.
- **Arc Radius:** For curves that are perfect circular arcs and not complex bezier curves, this is the radius of that arc. Value is empty otherwise.
- **Arc Center:** For curves that are perfect circular arcs and not complex bezier curves, this is the center point of that arc. Value is empty otherwise.

Below you can see further examples of the state of the measurement tool dialog, based on the type of segment being measured.

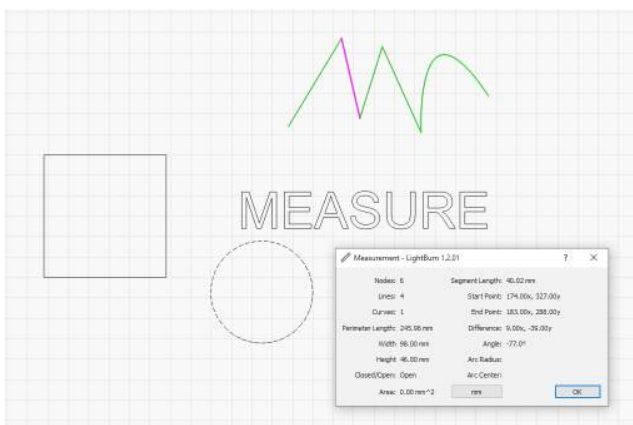
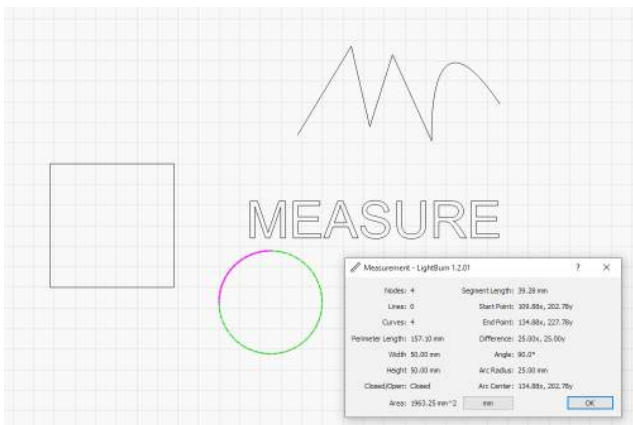

#### DRAG MEASURE

If you need to measure the distance between two shapes you can click and drag between two anchor points and get the above information but pertaining to the two nodes.

Primary Docs UI Tools

## Modifier Tools



The modifier tools, as the name suggests, are primarily used to modify existing shapes.

The tools are:

- [Modifier Tools](#)
- [Offset](#)
- [Weld](#)
- [Boolean Union](#)
- [Boolean Subtract](#)
- [Boolean Intersection](#)
- [Boolean Assistant](#)
- [Video Walkthrough of the Boolean Operations](#)
- [Grid Array](#)
- [Virtual Arrays](#)
- [Radial Array](#)
- [Start Point Editor](#)
- [Radiused Corners](#)



Offset

Hotkey = Alt + O

The offset tool is used to create outlines around existing shapes, either inward or outward, offset from the original by a given amount. We use the offset tool in the '[Making a Simple Project](#)' topic, so that's a great introduction.

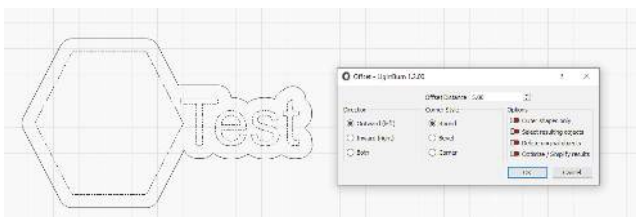

The corner style option chooses how outward corners are offset:

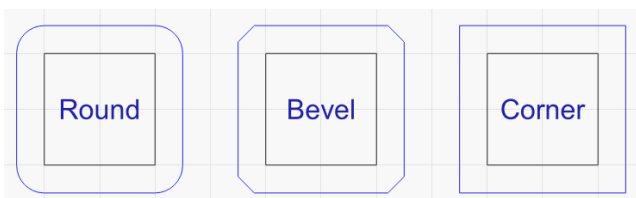

The offset tool remembers the last set of options you used, and if you hold the Ctrl key when you click the offset button, it will perform the offset operation using the previous settings, without bringing up the dialog.



Weld

Hotkey = Ctrl/⌘ + W

Clicking on the Weld icon will join all the selected shapes into a single entity that is the outline of all the selected shapes. Note that Weld requires closed shapes, but will accept an arbitrary collection of inputs, and tries to do the right thing, but sometimes gets it wrong. If you weld something and the middle content disappears, use Boolean Union instead.



Boolean Union

Union is similar to weld, but works with 2 selected objects only. However these selected objects can actually be grouped items, not just a single vector shape.



Boolean Subtract

Hotkey = Alt + -

Boolean subtract (also called Boolean Difference) will remove the area that the second selected shape overlaps the first shape by. The order in which you select shapes will determine the outcome. This tool also works with grouped items. If you end up subtracting the items in the wrong order, Undo, then perform the operation again - The undo switches the order of the items, so a simple Undo and click-again of of the Subtract button is a quick fix.



Boolean Intersection

Hotkey = Alt + \*

This will create a shape from 2 selected shapes that has an outline defined by only the areas in which the shapes overlap. This tool also works with grouped items.

The three different Boolean operations are shown here:

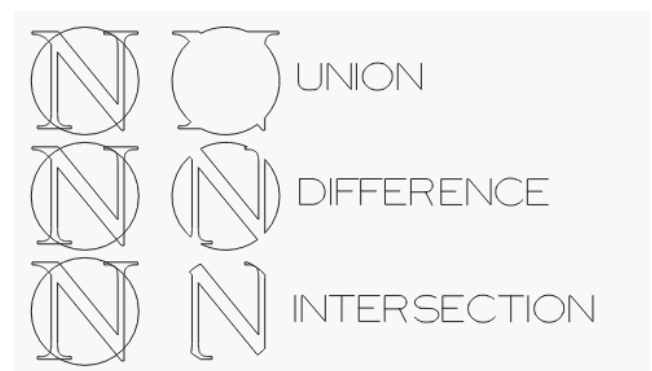

- Union keeps the area covered by either shape - it merges them.
- Difference is the 2nd shape removed from the first.
- Intersection keeps the area covered by both shapes.



**Boolean Assistant**

Hotkey = Ctrl/⌘ + B

Because it can be hard to remember which operation (or which order) is going to do the thing you want, we've added a new Boolean Helper that will let you preview each of the Boolean operations before deciding on one.

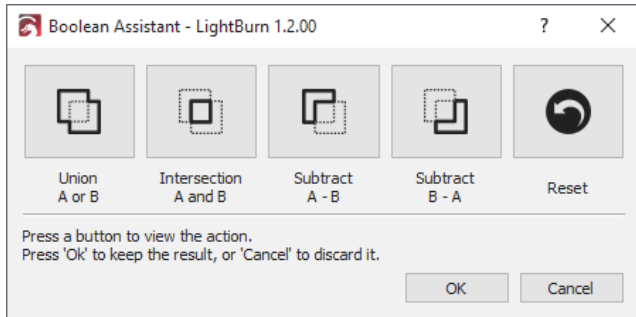

Click any of the first 4 buttons to see what that operation will look like, or click the 'Reset' button to see the original shapes. If your design is not complex, hovering over the buttons will also work. When you see the result you want, click the 'Ok' button to keep it, or click 'Cancel' to revert.

**Video Walkthrough of the Boolean Operations**

Click for a [Boolean demonstration video](#)

The above video describes in more detail how the various Boolean operations differ, and why welding text to a circle should be done with a Boolean Union instead.



**Grid Array**

The Grid Array tool allows you to copy a shape (or shapes) with regular spacing horizontally, vertically, or both, and includes options to adjust spacing, to shift odd rows, mirror the shapes, and more.

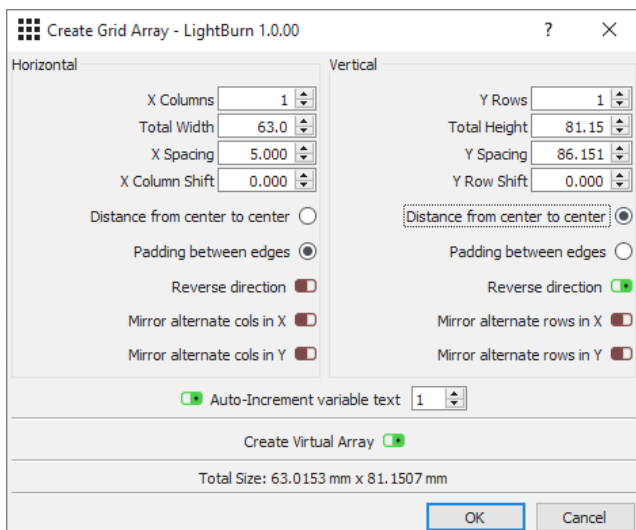

The X and Y columns settings let you specify how many copies of your shape to make in each direction.

Total Width and Total Height are convenience options that allow you to tell it the maximum size to occupy/ It will set

the X Columns and Y Rows values to whatever is necessary to fill the specified size without going over, based on the other provided settings.

Spacing can be specified between edges (how much padding between shapes) or between centers (absolute object spacing).

Column and Row Shift values let you offset alternate columns or rows, and you can mirror them as well, allowing you to more efficiently pack oddly shaped items together, like this:

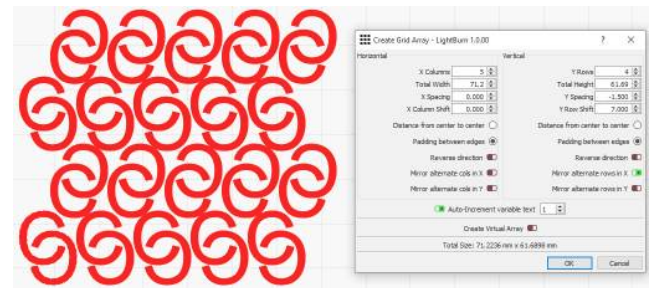

**Virtual Arrays**

There is also a Virtual Array option that can be selected by checking "Create Virtual Array" at the bottom of the Grid Array dialog. Instead of making copies of the original shapes, this will generate virtual clones of the original that stay synced at all times. When using a virtual array, the virtual clones will render with a dashed outline and muted color to denote they are virtual:

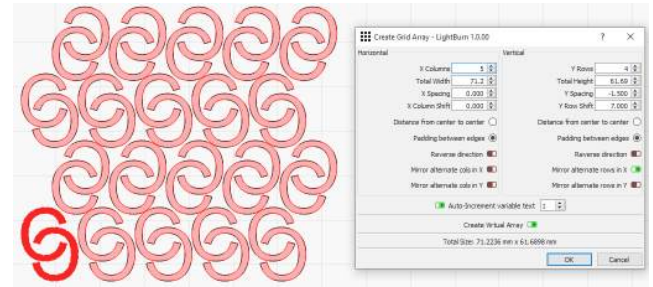

Note that these virtual shapes are not selectable and will always be laid out based on the array options you provided. However, any changes made to the original shapes are automatically reflected in the array.

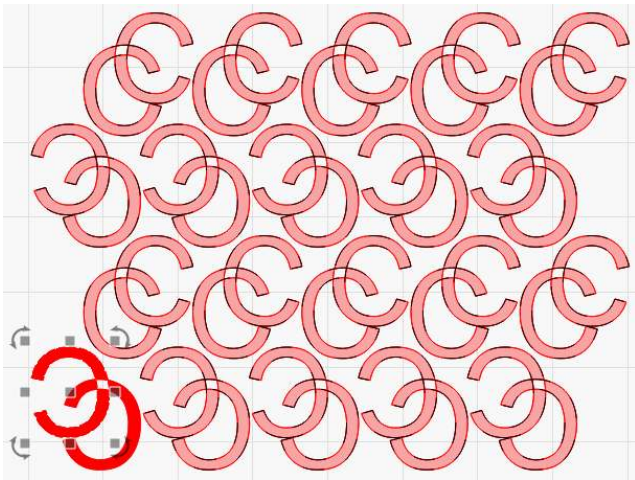

Beyond just altering the original shapes, there are many operations that can be done after the fact to virtual arrays, all of which are available from the shape context menu. This menu is available from any shape that is currently part of a virtual array. You do not have to select all shapes in that array first.

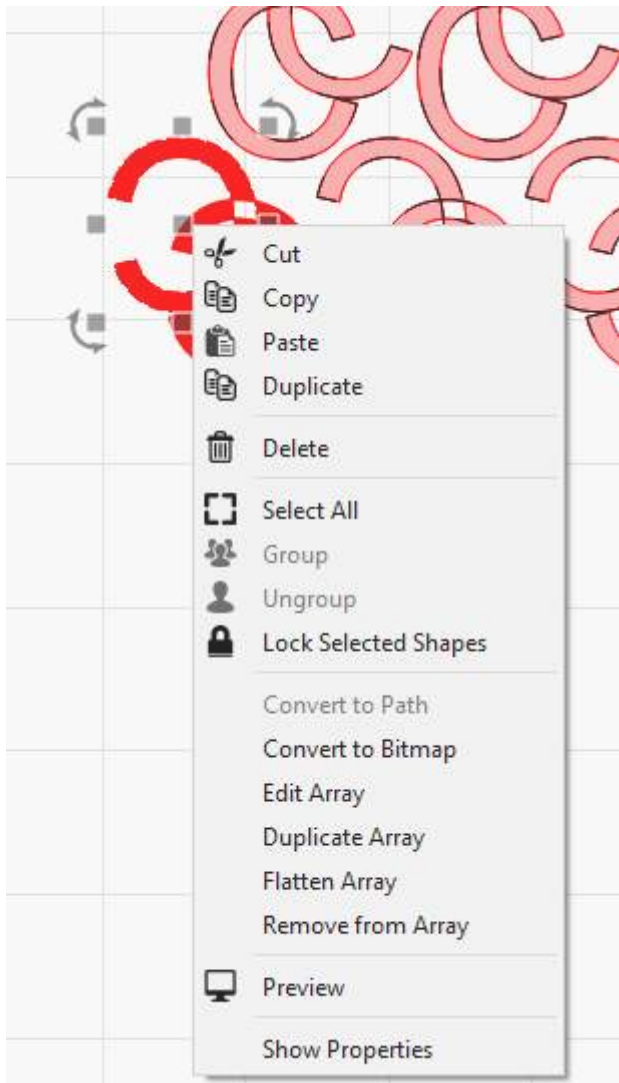

- **Edit Array:** Display the "Create Grid Array" dialog again, but for this existing array. This allows you to modify any of

the parameters and even convert it back into a normal array, by unchecking "Create Virtual Array".

- **Duplicate Array:** Virtual arrays cannot be selected directly, only the shapes included in them. So this allows you to duplicate an entire virtual array and all of the shapes in it.
- **Flatten Array:** Convert the virtual array into a standard array where all shapes are separate copies and no longer synced to the original shapes.
- **Remove from Array:** Remove the currently selected shape(s) from the virtual array.
- **Add to Array:** Add any currently selected shapes not in the virtual array to the array. Note, you must select at least one shape that is **in** a virtual array and one shape that is **not in** a virtual array currently.



Circular Array Tool

The Radial Array (or circular array) tool lets you create copies of a shape (or shapes) around a central point. This is useful for creating ornamental patterns, clock faces, and more.

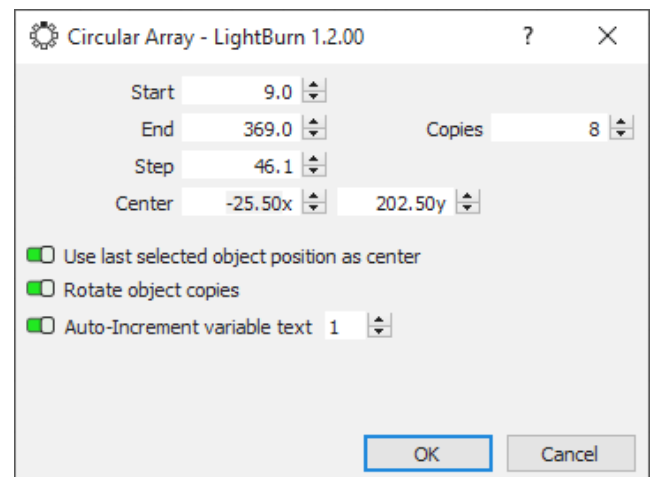

You can manually enter the point of rotation, but it's much simpler to create a shape to use as the center point, and select that shape last. The created copies can be rotated or not - Numbers on a clock, for example, are often left upright for readability, but roman numerals are usually rotated.

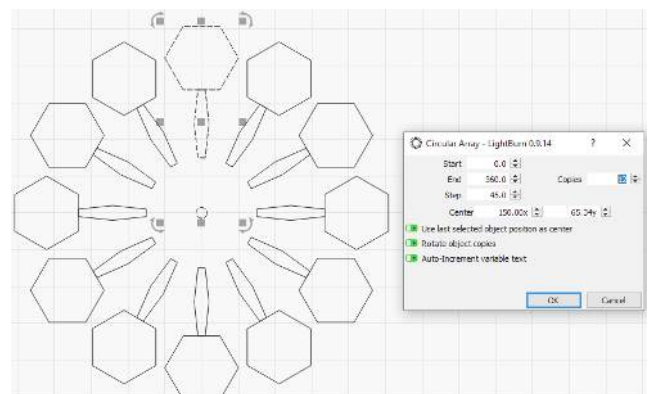

In the above example, the small center circle was selected last, and the 'Use last selected object position as center'

option is chosen, along with 'Rotate object copies' to produce the pattern.



The Start Point edit tool lets you tell LightBurn where to start cutting a shape, and in which direction. By default, the starting point is the first point of the shape, and the direction will be the direction that the selection marquee animates in. In the Optimization Settings, if you tell LightBurn to choose the best starting point or best direction, it can choose a different point than the default if it will reduce cutting time. The Start Point editor lets you force the starting point and direction.

With a shape selected, click the 'Start Point' tool and you'll see the starting point and direction indicated by an arrow. If the arrow is gray, it means this shape is displaying the default point and direction, but it is not forced. If you click any node on the shape, the arrow will move there, and turn blue, indicating that the user has chosen this as the starting point and direction.



Holding Shift and clicking a point will choose the opposite direction, and holding Ctrl and clicking the shape will clear the starting point back to the default.



The radius tool lets you round sharp corners where two lines meet. After clicking the Radiused Corners tool and entering a radius value below it, select a shape, then hover over a corner. If that corner can be curved, you should see the cursor change, like this:



If you click the corner, it will be rounded to the radius you've chosen, like this:



**Primary Docs UI Tools Editing**

**Two-Point Rotate and Scale**

This feature allows you to rotate an object around a pivot point.

**HOW TO USE**

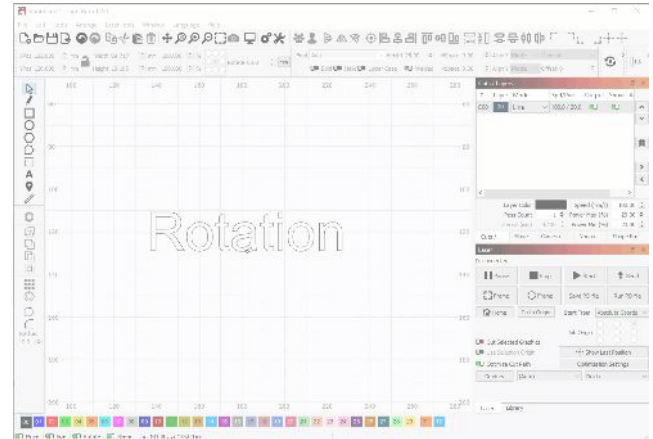

First, select the object you want to rotate.

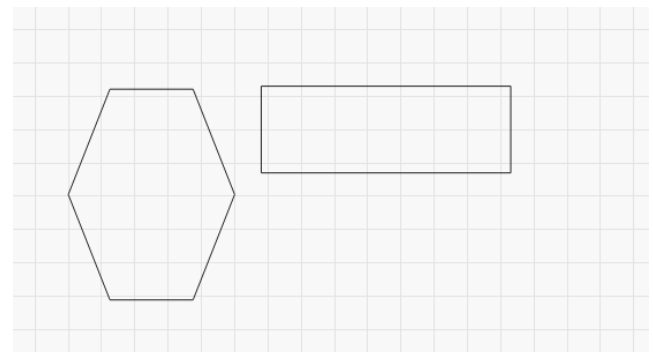

Then, click the "Two-Point Rotate / Scale" button in the "Arrange" menu (or **Ctrl** + **2**) to start the use of the tool.

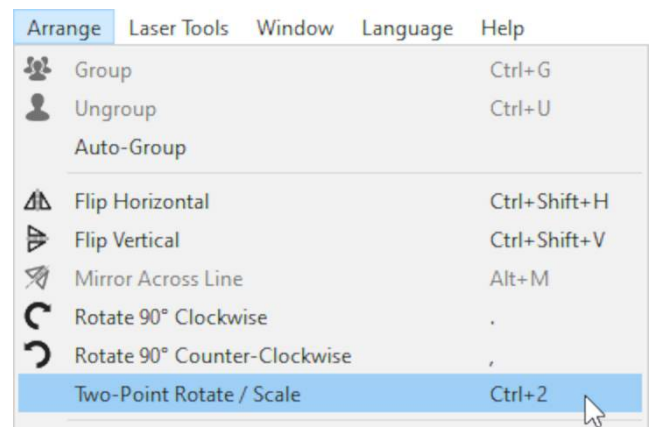

In the bottom right corner of the window, LightBurn will ask you to select the first point (the center of rotation). Click on a point in the editing area to do this.

### Select the first point - the center of rotation

If the point you're selecting is a corner point, the mouse cursor will change to a crosshair. This can help if you're trying to rotate around a very specific point.

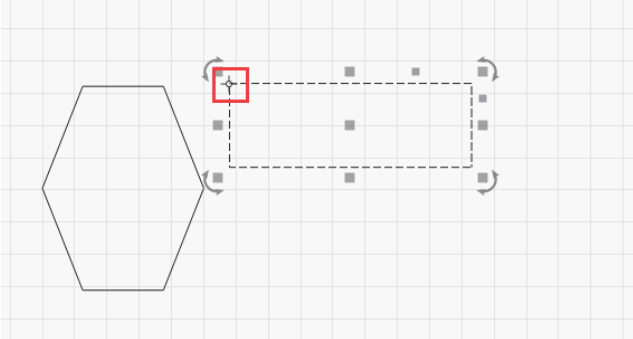

After confirming your first point, the instructions in the bottom right corner will update to ask you to select the second point. Your cursor will also change.

### Click and drag the 2nd point, where you will rotate from

By clicking and dragging you can rotate the shape, and LightBurn will give you a preview as you move your mouse.

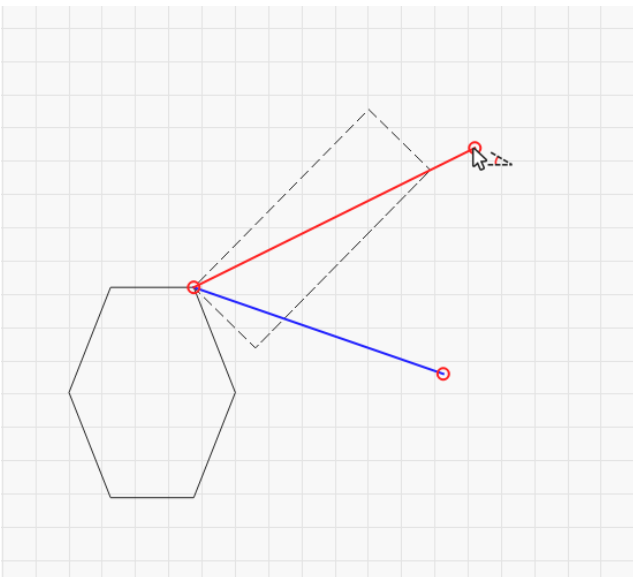

When the mouse is released, your object will be rotated as intended.

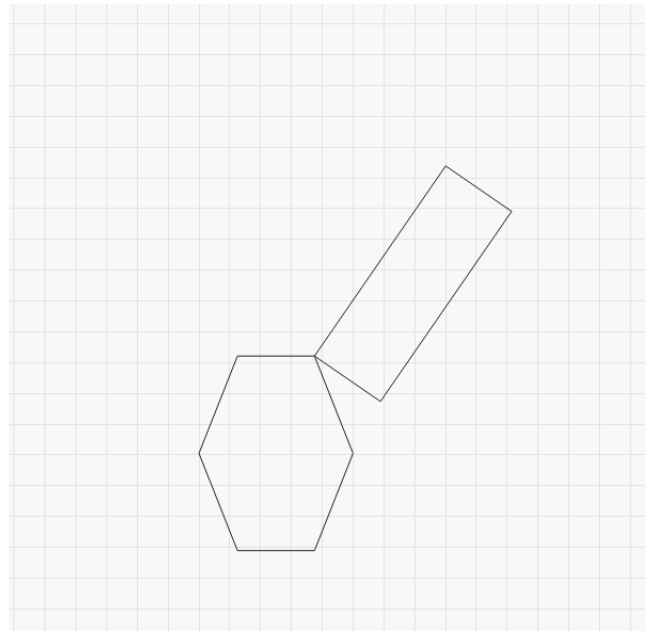

## Primary Docs UI

### Material Test

#### ABOUT THE MATERIAL TEST FUNCTION

LightBurn has a built-in feature for generating test patterns. You can use this to identify the best settings for your laser and material combination. You can find it in the LightBurn menu by going to **Laser Tools > Material Test**

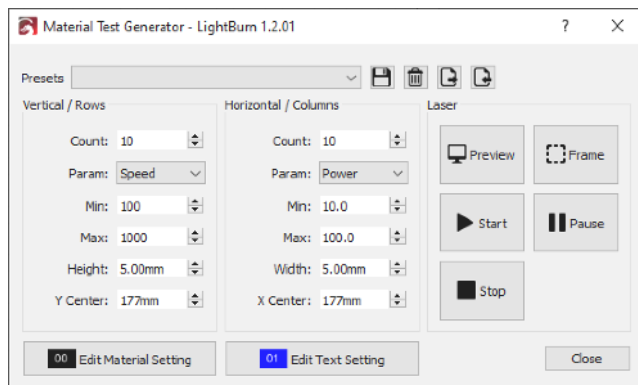

The settings in this dialog box will let you configure your test pattern. To the right, you'll have buttons to preview the test pattern, frame it on the material, start, pause, and stop.

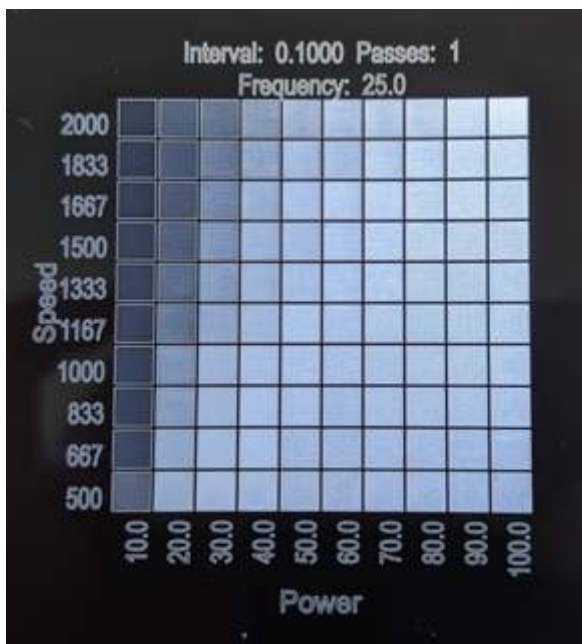

Material Test Example

The example to the right shows what you can expect after running a material test. On the left side, you can see a range of speeds, and on the bottom you can see a range of power levels. At the top, you can see the settings for **interval**, **passes**, and **frequency**. The material test generator defaults to varying **power** and **speed**, but you can choose to make your grid with any 2 of the available settings with the "param" dropdowns.

Galvo lasers with the appropriate source can also test **Q-pulse** combined with the above options.

#### USING THE MATERIAL TEST FUNCTION

The rows and columns can be controlled independently, using the settings in the dialog box.

At the bottom of the dialog box, you'll see buttons for "Edit Material Setting" and "Edit Text Setting". Each of these buttons will open a **cut settings editor window** for you to adjust the settings you want to use. The **material settings** will control the settings for the test grid, aside from the two parameters being tested. The **text settings** will allow you to set the cut settings for the text labels.

At the top are buttons allowing you to save, delete, export, and import presets. There is also a dropdown allowing you to select a saved preset. This is useful if you have custom settings you like to run frequently, for instance a smaller test pattern you want to use on metal tags or a range of settings you want to test on different woods.

## QR Code Generation

**QR Codes** are square 2D barcodes that can be scanned by a mobile device with a camera. They are able to store and convey a wide variety of information, such as simple text, a URL, or even WiFi access information, such as the example shown below.



Most modern mobile devices with a camera include some sort of built in QR code scanning ability, often direct from the stock camera application. Simply point the camera at the code and it will recognize it and provide a prompt to proceed with whatever information is contained. If this does not work, check the documentation for your specific device. In some cases, you may need to download a barcode scanning application.

### USAGE

LightBurn can easily generate QR Codes for you using the QR Code tool. Navigate to the **Tools** Menu and then select **Create QR Code** as shown below.

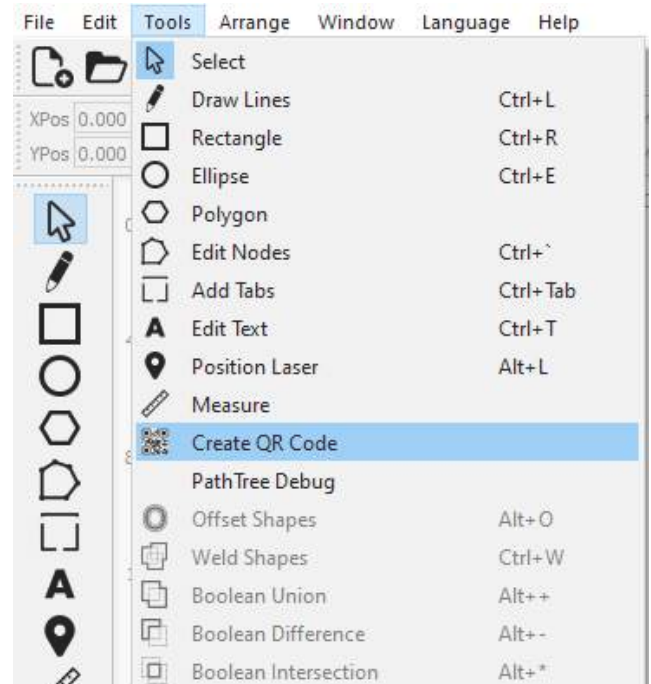

With the QR tool selected, click and drag in the Edit Window where it will show a square being drawn, this will be the initial size of your QR Code. Once you release the mouse button, you will be shown the **QR Code Properties** dialog.

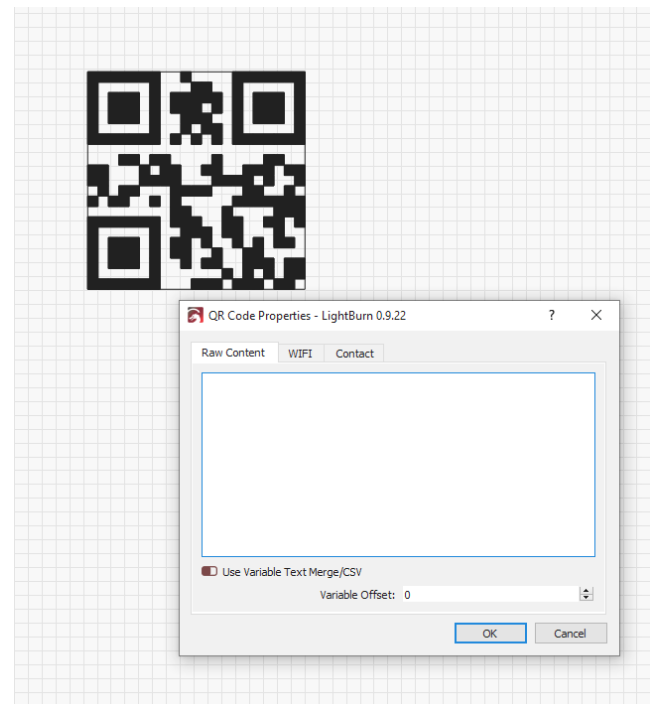

From here there are 3 main options for QR code content:

- Raw content: typically plain text or URLs
- WIFI: Creates a WiFi access point configuration code for mobile devices.
- Contact: Creates a "Contact Card" code which will load contact info into your mobile device's contacts.

As you enter QR Code content you will see the QR code in the edit window update in realtime. The more content you add, the smaller the sub-squares will become to fit all of that data. You can always scale the size of the QR Code after the fact, if needed.

Note that you may also edit an existing QR code object by selecting it, right clicking, and choosing the `Edit QR Code` option. This will bring up the same `QR Code Properties` dialog as before with all the information filled in.

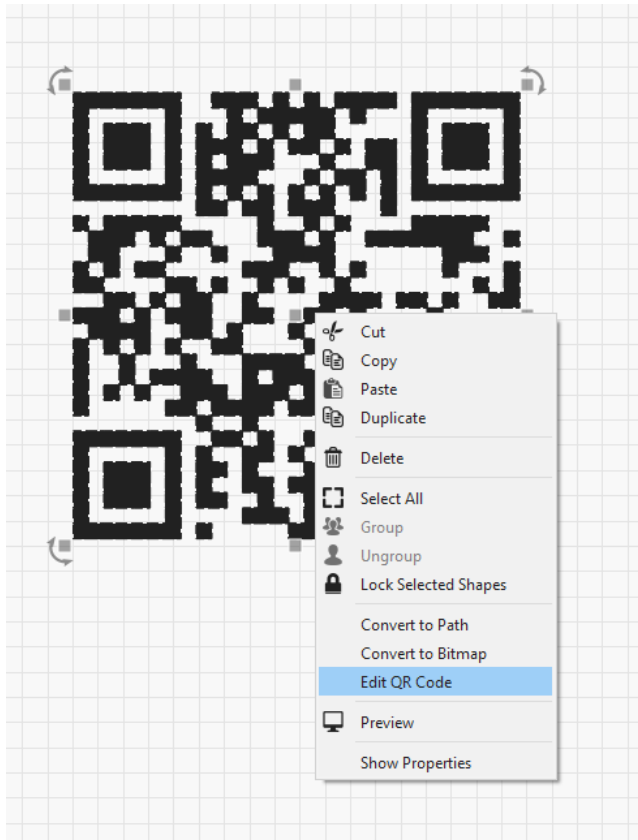

#### Raw Content

This is the simplest and most flexible option as it allows you to enter any text you would like. At the simplest this is just basic plain text or a URL. But there are a wide variety of other options supported by many mobile devices such as email addresses, phone numbers, geo-location information, and more. There is a great list explaining the options and how the text must be formatted on the [zxing barcode scanner documentation](#).

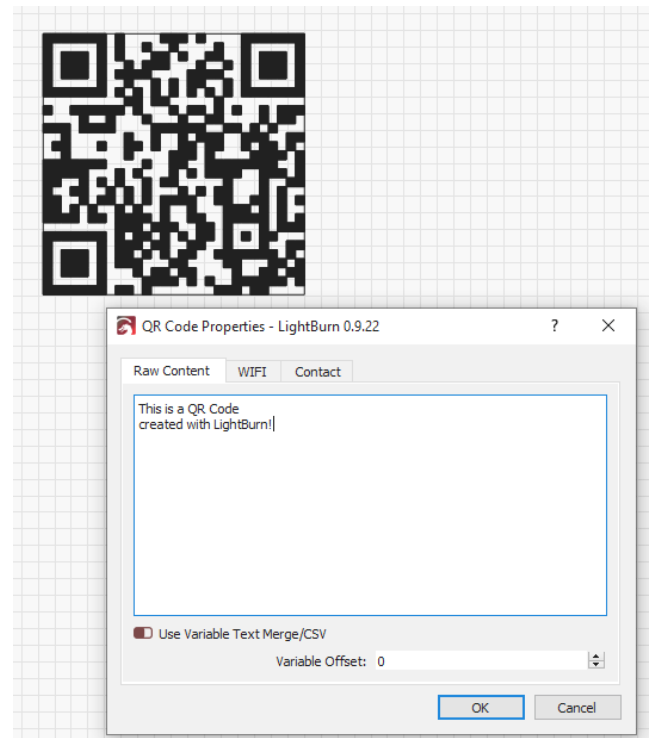

#### WiFi

With with WIFI tab you can create a barcode that, when scanned, will allow that mobile device to automatically connect to a WiFi access point with all of the connection information provided.

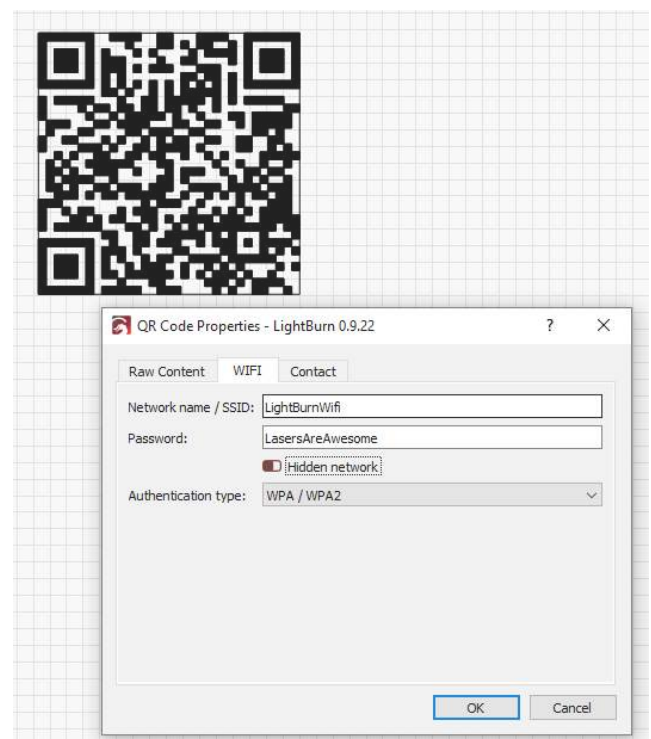

The input options are:

- Network name / SSID: The configured name of the access point

- Password: The WEP or PSK password for the network if one is required (see Authentication type below)
- Hidden network: When checked this specifies that the SSID of the network to connect to is not broadcast publicly and that the mobile device should act accordingly.
- Authentication type: Choose from WPA/WPA2, WEP, or None. Typically most modern access points use WPA2. Check the configuration on your access point if you are unsure.

Once you've entered the WiFi access point information the content under the `Raw Content` tab will automatically be updated to reflect the WiFi configuration. As shown below:

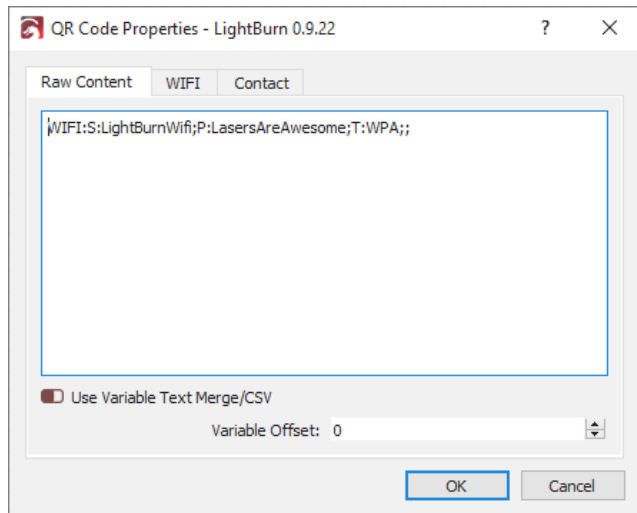

The WiFi raw content format is described in more detail in the [zxing barcode documentation](#).

#### Contact

With the Contact tab you can create barcodes that contain contact information which can then be automatically loaded into a mobile device's contacts storage.

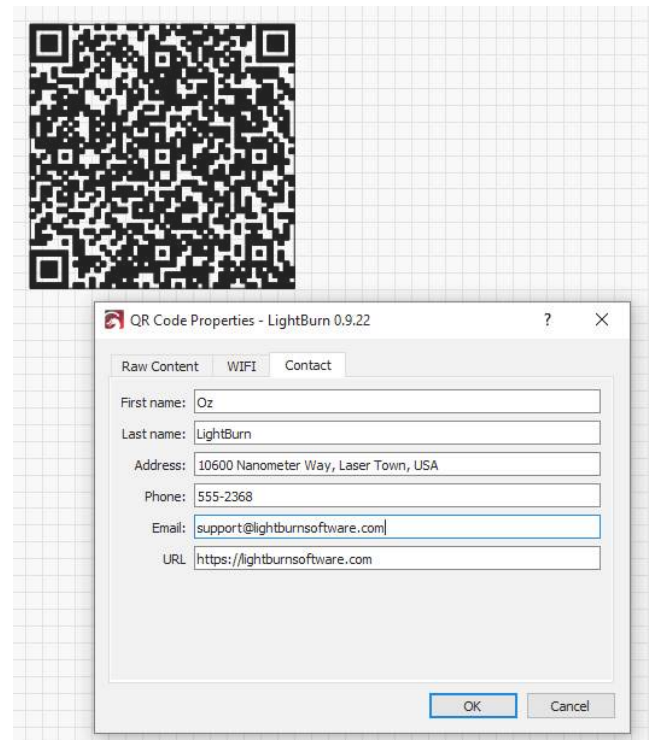

Just like with the WiFi tab, once information is entered on the Contacts tab, if you go back to the Raw Content tab you will see the raw contact card shown, which in this case is in the "MECARD" format.

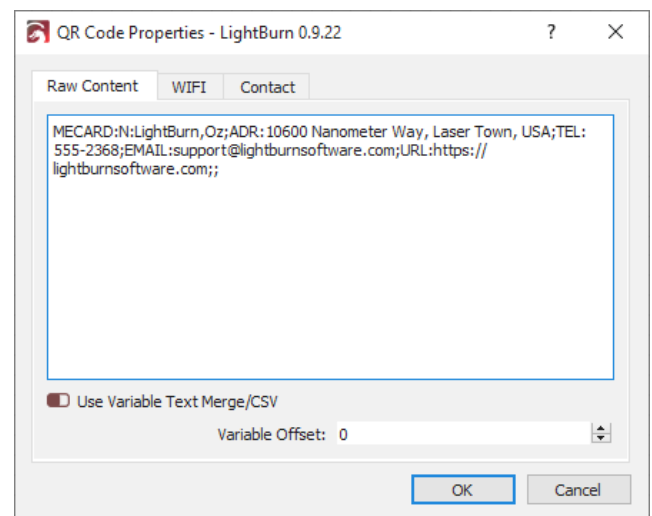

#### CUT SETTINGS

Because of the way QR Codes work it's assumed that there is a high amount of contrast between the light and dark sections of the barcode. Most importantly the dark sections must be completely filled so you should be sure to use the "Fill" mode on the cut layer being used for the QR Code. If in LightBurn you see the QR Code render as shown below, that means you either are not using "Fill" mode on that cut layer or filled rendering is turned off.



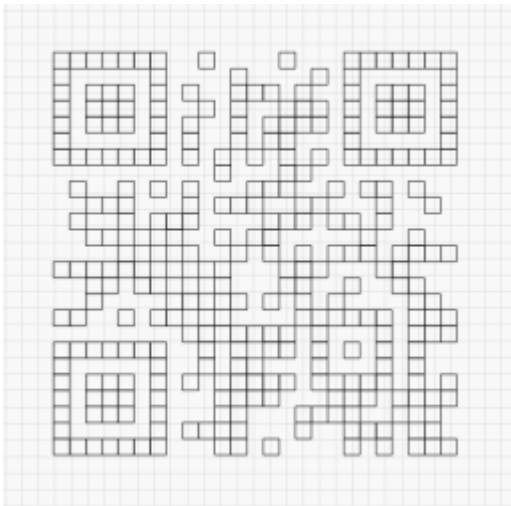

Once in "Fill" mode, be sure to set an appropriate power level for the material you are using in order to provide sufficient contrast between the fill engraved areas and the base material similar to what you see below:



You can enable filled rendering from the **Window** menu by choose **Filled / Coarse** OR **Filled / Smooth**

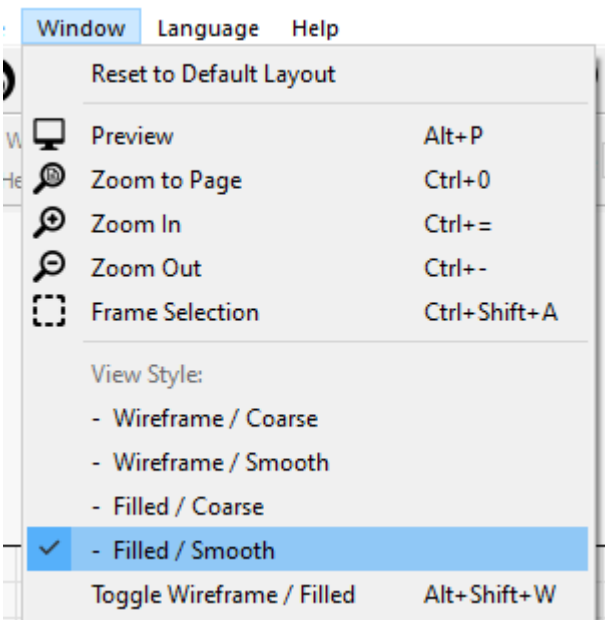

If you would rather not enable filled rendering in the edit window, you can also see a preview of what the filled QR code will look like by launching the cut Preview. You will, of course, still need to have the QR code on a "Fill" mode cut layer.

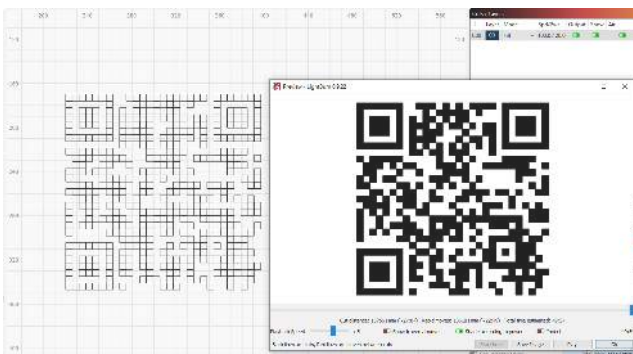

## Variable Text

**Primary Docs**   **Text & Fonts**   **Tools**

### VARIABLE TEXT IN LIGHTBURN

Variable text is a feature that allows you to use special codes in your text entries that will be substituted for something else when you send the data to the laser (or the preview). Variable text can be used for:

- Date or time stamps
- Serial numbers
- Displaying cut settings
- Merging a CSV file into your designs

In all of these cases, the text in LightBurn is set to one of the dynamic text modes, and the text entered is used to tell LightBurn what you want it to display. You select the text mode like this:

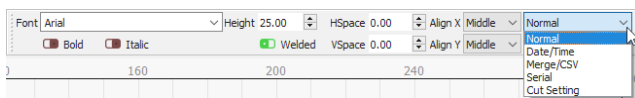

With the mode selected, you enter one of the special codes for that mode, and when you preview, save, or send the file to the laser, LightBurn will replace the text with the desired output.

The different formatting codes are listed here: [Variable Text Formats](#)

### Variable Text Manager

If using serial numbers or a CSV file, you have additional controls, available in the Variable Text window in LightBurn, shown below:

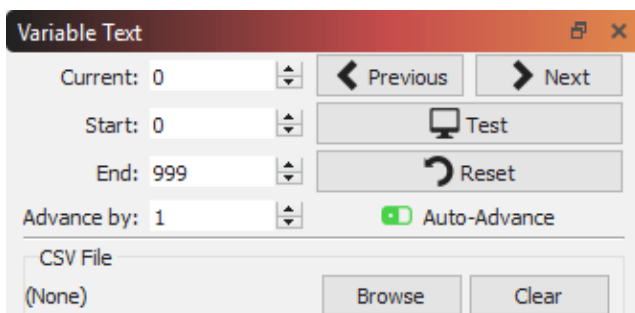

The values shown are:

**Current:** The current serial number, or row from the CSV file, that will be displayed.

**Start:** The first serial number you want to use, or the first row in the CSV file to be used.

**End:** The last serial number to use, or the last row in the CSV file to use.

**Advance by:** Imagine you are creating a series of numbered labels. Rather than cutting each one separately, you would most likely want to do several at once on a page. The "Advance by" value tells LightBurn how many entries to

advance ahead when you click the Next or Previous buttons, or when it automatically advances to the next page for you.

The buttons on the right are for:

**Previous:** Go to the previous page of values (decrements the Current entry by the 'Advance by' amount)

**Next:** Go to the next page of values (increments the Current entry by the 'Advance by' amount)

**Test:** Displays the text that will be output, for as long as the button is pressed.

**Reset:** Resets the Current value to the Start value

**Auto-Advance:** When this switch is enabled, each time you press one of the 'Start', 'Send' or 'Save as..' buttons in the Laser window, LightBurn will automatically advance the Current value by the 'Advance by' amount. If you are running a large batch of parts, names, serial numbers, etc, each time you send a job to the laser the software will advance to the next batch.

Text objects within LightBurn have a property called **Offset**. This value is added to the current variable text index when evaluating the text object. This allows you to have text objects on your design that display different serial numbers, or different rows from the CSV file.

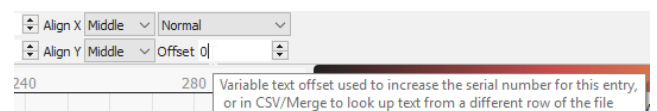

If you created a design with 4 name tag labels on the page, you would set the Variable Offset value for each of the four labels to 0, 1, 2, and 3, and tell the Variable Text manager to advance by 4 with each run.

### Automatic Arrays

When copying a text shape using **Grid Array**, **Circle Array**, or **Copy along Path**, LightBurn can automatically advance the 'Offset' value on your variable text objects for you. In this way you can quickly create full sheets of items containing serial numbers or CSV file references.

**VARIABLE TEXT FORMATS**

These are the different formatting codes used for Variable Text in LightBurn.

**Date / Time text format**

When using the Date/Time mode for text, the system will automatically substitute special combinations of characters with values for the current local date and time.

For example, if your text field is "d/MM/yyyy" the system would replace it with "15/6/2019". The values you can use for substitution are listed below.

These expressions may be used for the date:

Output	Expression
the day as number without a leading zero (1 to 31)	d
the day as number with a leading zero (01 to 31)	dd
the abbreviated localized day name (e.g. 'Mon' to 'Sun'). Uses the system locale to localize the name.	ddd
the long localized day name (e.g. 'Monday' to 'Sunday'). Uses the system locale to localize the name.	dddd
the month as number without a leading zero (1-12)	M
the month as number with a leading zero (01-12)	MM
the abbreviated localized month name (e.g. 'Jan' to 'Dec'). Uses the system locale to localize the name.	MMM
the long localized month name (e.g. 'January' to 'December'). Uses the system locale to localize the name.	MMMM
the year as two digit number (00-99)	yy
the year as four digit number	yyyy

These expressions may be used for the time:

Expression	Output
h	the hour without a leading zero (0 to 23 or 1 to 12 if AM/PM display)
hh	the hour with a leading zero (00 to 23 or 01 to 12 if AM/PM display)
H	the hour without a leading zero (0 to 23, even with AM/PM display)
HH	the hour with a leading zero (00 to 23, even with AM/PM display)
m	the minute without a leading zero (0 to 59)
mm	

Expression	Output
	the minute with a leading zero (00 to 59)
s	the whole second without a leading zero (0 to 59)
ss	the whole second with a leading zero where applicable (00 to 59)
z	the fractional part of the second, to go after a decimal point, without trailing zeroes (0 to 999). Thus "s.z" reports the seconds to full available (millisecond) precision without trailing zeroes.
zzz	the fractional part of the second, to millisecond precision, including trailing zeroes where applicable (000 to 999).
AP or A	use AM/PM display. A/AP will be replaced by either "AM" or "PM".
ap or a	use am/pm display. a/ap will be replaced by either "am" or "pm".
t	the time zone (for example "CEST")

Any sequence of characters enclosed in single quotes will be included verbatim in the output string (stripped of the quotes), even if it contains formatting characters. Two consecutive single quotes (") are replaced by a single quote in the output. All other characters in the input string are included verbatim in the output string.

Formats without separators (e.g. "ddMM") are supported but must be used with care, as the resulting strings aren't always reliably readable (e.g. if "dM" produces "212" it could mean either the 2nd of December or the 21st of February).

Example format strings (for the date & time 21 May 2001 14:13:09.120):

Input	Result
dd.MM.yyyy	21.05.2001
ddd MMMM d yy	Tue May 21 01
hh:mm:ss.zzz	14:13:09.120
hh:mm:ss.z	14:13:09.12
h : m : s ap	2 : 13 : 9 pm

**Serial number text format**

When using the Serial mode for text, the system will automatically substitute certain special combinations of characters with the current serial number value, and other characters control how it is formatted.

These expressions may be used for serial numbers:

Output	Expression
The serial number as a decimal value	d

Output	Expression
The serial number as a hexadecimal value, lower case	h
The serial number as a hexadecimal value, upper case	H
Tells LightBurn to pad the number with leading zeros	0

The number of characters used controls how many digits the system will display. If the serial number is larger than the number of digits allowed, as many digits as will fit from the end of the number will be displayed. For example, if your serial number is 1234, the table below shows how that number would be formatted for each of the displayed formatting inputs:

Input	Output	Input	Output
d	4	0d	4
dd	34	0dd	34
ddd	234	0ddd	234
dddd	1234	0dddd	1234
dddddd	1234	0dddddd	01234
ddddddd	1234	0ddddddd	001234

You cannot mix decimal and hexadecimal formatting in the same text entry, and you cannot split a serial number with other characters. For example, this string is not valid: ddd-ddd because of the hyphen between the two groups of format characters.

Like the Date / Time formatting, any text between a pair of single quotes is copied exactly to the output, and a pair of single quotes together is replaced by one single quote in the output.

#### CSV/Merge text format

When using the CSV/Merge mode for text, the system will automatically substitute certain special combinations of characters with entries from the selected row of a CSV file. A CSV file is "Comma Separated Values" - a very simple text format that uses a line in the file as the row, and commas to separate columns in the file.

For example:

```
LightBurn,80,10
Core1,300,20
```

In a CSV/Merge entry in LightBurn, the text you enter uses the percent sign followed by a number to look up a column in the current row of the CSV file. For example, using this text with the above table:

I'm thinking of buying %0 - it costs \$%1

Would display:

I'm thinking of buying LightBurn - it costs \$80

Columns are numbered starting from 0.

#### Cut Setting text format

When using the Cut Setting mode for text, the system will automatically substitute certain characters with values from the cut setting applied to the text.

Like the Date / Time or Serial number formatting, any text between a pair of single quotes is copied exactly to the output, and a pair of single quotes together is replaced by one single quote in the output.

Expression	Output
C	followed by a number, pulls settings from the numbered cut layer (ex, C03) for the remainder of this string
s	speed, as a number in the current speed units
S	speed, including the current units (like mm/sec)
p	max power, as a percentage
P	max power, including the percent sign
m	min power, as a percentage
M	min power, including the percent sign
d / D	DPI, as a number, always dots per inch
i	interval, in the current distance units
I	interval, including the current distance units (like mm)
L	Displays the name of the laser. Can optionally be followed by a character index to start displaying from, and optionally, a comma and a 2nd number for the number of characters to display. For example, if L displayed 'Ruida 6442G', L6 would display '6442G', and L6,4 would display '6442' (without the quotes)
z	Z offset for the current layer, in the current distance units
Z	Z offset for the current layer including the units (eg, mm)
q	Q-pulse width
Q	Q-pulse width, followed by 'ns' to indicate the units
k	frequency in kHz
K	frequency in kHz, followed by 'kHz' to indicate the units

## 4.5.4 Hotkeys and Gestures

Most feature hot-keys can be found next to the action in the menus.

## 4.5.5 General Usage Hotkeys

### Mouse

- **Selection:** Left click, or band-box
- Shift + click adds to the current selection
- Ctrl/⌘ + click removes from the current selection
- **Drag:** Left-click & hold on an object, drag it
- When dragging, Shift will keep the drag vertical, horizontal, or 45 degrees
- When dragging, Ctrl means "don't grid / object snap"
- When sizing, the default is retain the current aspect ratio, holding shift unlocks it.
- When sizing, Control means "resize from center"
- **Zoom:** Mouse wheel (zooms relative to the cursor)
- **View drag:** Middle-mouse click and drag
- **Double clicking text:** Auto chooses text mode and places cursor.

### Keyboard

- **View drag:** Hold space-bar + left-click & drag (useful for Mac, or users without a mouse wheel)
- **Delete:** Backspace or Delete keys
- **Select Mode:** Pressing the Esc key while in the workspace will return to the selection tool

### MOVE

- Arrow keys move the current selection
- Shift + arrow moves in large steps
- Ctrl/⌘ + arrow moves in small steps

### Menu Hot-Keys

#### FILE

Action	Windows / Linux	macOS
New	Ctrl + N	⌘ + N
Open	Ctrl + O	⌘ + O
Import	Ctrl + I	⌘ + I
Save	Ctrl + S	⌘ + S
Save As	Ctrl + Shift + S	⌘ + Shift + S
Save As Gcode	Alt + Shift + L	Alt + Shift + L
Export	Alt + X	Alt + X
	Ctrl + P	⌘ + P

Action	Windows / Linux	macOS
Print (Black Only)		
Print (Keep Colors)	Ctrl + Shift + P	⌘ + Shift + P
Exit	Ctrl + Q	⌘ + Q

#### EDIT

Action	Windows / Linux	macOS
Undo	Ctrl + Z	⌘ + Z
Redo	Ctrl + Shift + Z	⌘ + Shift + Z
Select All	Ctrl + A	⌘ + A
Invert Selection	Ctrl + Shift + I	⌘ + Shift + I
Cut	Ctrl + X	⌘ + X
Copy	Ctrl + C	⌘ + C
Duplicate	Ctrl + D	⌘ + D
Paste	Ctrl + V	⌘ + V
Paste in place	Alt + V	Alt + V
Delete	Delete / BackSpace	Delete / BackSpace
Convert to Path	Ctrl + Shift + C	⌘ + Shift + C
Convert to Bitmap	Ctrl + Shift + B	⌘ + Shift + B
Close Path	Alt + C	Alt + C
Auto Join	Alt + J	Alt + J
Optimize	Alt + Shift + O	Alt + Shift + O
Delete Duplicates	Alt + D	Alt + D

#### VECTOR TOOLS

Action	Windows / Linux	macOS
Draw Line	Ctrl + L	⌘ + L
Rectangle	Ctrl + R	⌘ + R
Ellipse	Ctrl + E	⌘ + E
Edit Nodes	Ctrl + `	⌘ + `
Add Tabs	Ctrl + Tab	⌘ + Tab
Create / Edit Text	Ctrl + T	⌘ + T
Offset Shapes	ALT + O	⌘ + O

Action	Windows / Linux	macOS
Weld Shapes	Ctrl + W	⌘ + W
Boolean Union	Alt + +	Alt + +
Boolean Subtract	Alt + -	Alt + -
Boolean Intersection	Alt + *	Alt + *
Boolean Assistant	Ctrl + B	⌘ + B
Break Apart	Alt + B	Alt + B
Cut Shapes	Alt + C	Alt + C

**IMAGE TOOLS**

Action	Windows / Linux	macOS
Adjust Image	Alt + I	Alt + I
Trace Image	Alt + T	Alt + T

**WINDOW**

Action	Windows / Linux	macOS
Preview	Alt + P	Alt + P
Zoom In	Ctrl + =	⌘ + =
Zoom Out	Ctrl + -	⌘ + -
Zoom to Page	Ctrl + 0	⌘ + 0
Preview	Alt + P	Alt + P
Toggle WireFrame/ Filled	Alt + Shift + P	Alt + Shift + P
Frame Selection	Ctrl + Shift + A	⌘ + Shift + A
Square Frame Selection	Alt + R	Alt + R
Rubber Band Frame	Alt + Shift + R	Alt + Shift + R

**LASER MACHINE TOOLS**

Action	Windows / Linux	macOS
Rotary Setup	Ctrl + Shift + R	⌘ + Shift + R
Position Laser	Alt + L	Alt + L
Pause	Pause	
Stop	Ctrl + Break	

Action	Windows / Linux	macOS
Reset Device Connection	Right Click "Devices"	

**CUTS/LAYERS**

Action	Windows / Linux	macOS
Flash items on Layer	Right Click Layer	Right Click Layer
Select all items on layer	Shift+Click Layer	Shift+Click Layer

**Global Hotkeys**

The following work from anywhere while objects are selected.

Action	Windows / Linux	macOS
Group	Ctrl + G	⌘ + G
Ungroup	Ctrl + U	⌘ + U
Flip Horizontal	Ctrl + Shift + H	⌘ + Shift + H
Flip Vertical	Ctrl + Shift + V	⌘ + Shift + V
Mirror Across Line	Ctrl + Shift + M	⌘ + Shift + M
Align Left	Ctrl + Shift + ←	⌘ + Shift + ←
Align Right	Ctrl + Shift + →	⌘ + Shift + →
Align Top	Ctrl + Shift + ↑	⌘ + Shift + ↑
Align Bottom	Ctrl + Shift + ↓	⌘ + Shift + ↓
Align Centers Vertically	Ctrl + Shift + PgUp	⌘ + Shift + PgUp
Align Centers Horizontally	Ctrl + Shift + PgDn	⌘ + Shift + PgDn
Move H-Together	Alt + Shift + H	Alt + Shift + H
Move V-Together	Alt + Shift + V	Alt + Shift + V
Push forward in draw order	PgUp	PgUp
Push backward in draw order	PgDn	PgDn
Push to front	Ctrl + PgUp	⌘ + PgUp
Push to back	Ctrl + PgDn	⌘ + PgDn

**Edit Window Specific**

The following work only while focused on the edit window.

Action	Windows / Linux	macOS
Rotate 5° clockwise	Ctrl + Shift + . (decimal)	⌘ + Shift + . (decimal)
Rotate 5° Counter-clockwise	Ctrl + Shift + , (comma)	⌘ + Shift + , (comma)
Rotate 10 clockwise	Ctrl + . (decimal)	⌘ + . (decimal)
Rotate 10 Counter-clockwise	Ctrl + , (comma)	⌘ + , (comma)
Rotate 90 clockwise	. (decimal)	. (decimal)
Rotate 90 Counter-clockwise	, (comma)	, (comma)
Rotate 45 clockwise	Shift + >	Shift + >
Rotate 45 Counter-clockwise	Shift + <	Shift + <
Two Point Rotate Tool	Ctrl + 2	⌘ + 2
Align Left	L	L
Align Right	R	R
Align Top	T	T
Align Bottom	B	B
Align Centers Vertically	C	C
Align Centers Horizontally	E	E
Move Selection to Page Center	P	P

**Tool In-use - Hot-Keys**

**NODE EDIT**

Action	Windows / Linux	macOS	Notes
Smooth corner node	S	S	while hovering over a node
Convert line to smooth curve	S	S	while hovering over a line
	L	L	while hovering

Action	Windows / Linux	macOS	Notes
Convert curve to line			over a curve
Convert smooth node to corner	C	C	while hovering over a node
Delete node	D	D	while hovering over a node
Delete line	D	D	while hovering over a line
Insert node point	I	I	while hovering over a line or curve
Insert node at midpoint	M	M	while hovering over a line or curve
Break shape at point	B	B	while hovering over a point
Trim line	T	T	while hovering over a line, trim line under mouse at next intersection
Extend line	E	E	while hovering over a point, extend line from point under mouse to intersection with another shape

**PRINT AND CUT**

Action	Windows / Linux	macOS
Start Wizard	Alt + 0	Alt + 0
Set First Target Position	Alt + 1	Alt + 1
Set Second Target Position	Alt + 2	Alt + 2

Action	Windows / Linux	macOS
Align Output to Targets	Alt + 3	Alt + 3
Align Output to Targets (no scaling)	Alt + 4	Alt + 4

## CAMERA

Action	Windows / Linux	macOS
Update camera overlay	Alt + C	Alt + C

## KEYPAD JOG

**Note - Numlock must be enabled in Windows and Linux to use Keypad jogging**

Jog moves the laser in the jog increments set in the [Move tab](#).

To activate keypad jog you must first click in the workspace area and not have the text tool active. (Press **Esc** for the selection tool for example)

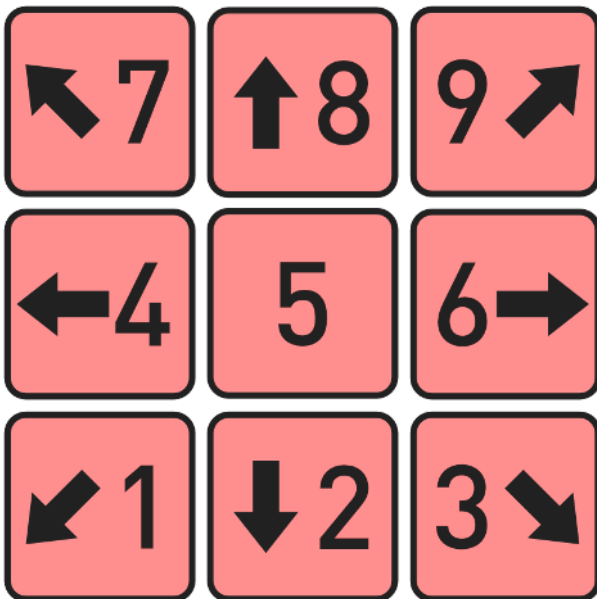

## HELP

- Pressing F1 while hovering the mouse over the edit window will bring you to the documentation page for the editing mode you're in.
- Pressing F1 while hovering the mouse over some tools will show you help for that tool.
- Otherwise, pressing F1 will bring up the **Help & Notes** dialog window.

## Printable Hot Key Guide

[Click to Download](#)



## 4.6 Advanced Topics

**Primary Docs    Advanced    Primary Docs**

### 4.6.1 Optimization Settings (Cut Planner)

The cut planner gives you a great deal of control over the ordering of your cuts - you can let LightBurn try to choose the best path for you, order it piece by piece yourself, or somewhere in between. If you have "Order by Layer" as the only entry in the list at the top (the default), it will behave the way you're used to. After selecting your choices in the Cut Planner, use the Preview (Alt-P) to see how your choices have impacted things by using the slider at the bottom of the window.

Access these settings by pressing the Optimization Settings button shown here:

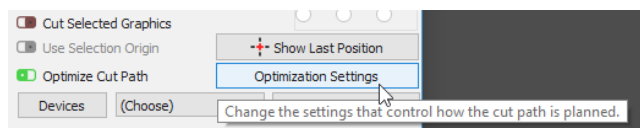

The settings are displayed in this dialog (and the defaults are shown here):

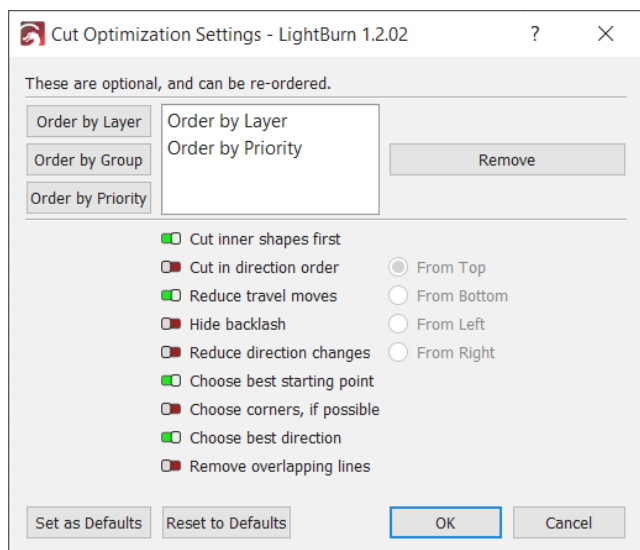

#### Order By

You can select what the initial ordering parameters will be. You have a choice of Layer, Groups or Priority. As well you can use a combination of these three choices in any order you wish.

Note that the order is important. If you order by layer, then groups, the list of shapes will be split into lists by layer first, then those lists will be sorted by group, and finally, the remaining optimizations will be applied. If you order by groups first, then by layers, the list of shapes will be first

split by root-level groups, *then* the shapes within each set will ordered by layer, and so on. This is good for doing large projects where you want an entire multi-layer item to complete before moving on to the next, in case you have to interrupt the project, or something goes wrong.

Each 'Order By' option produces a set of outputs that is then fed into the next option (if any), and so on. Each resulting set is then optimized with the additional options (like inner shapes first, reduce travel moves, etc).

#### ORDER BY LAYER

If you choose Order By Layer, the cut planner will apply all remaining optimizations to the first layer, then the second layer, and so on.

#### ORDER BY GROUPS

If you choose Order By groups the cut planner will apply all remaining optimizations to all the objects in a root-level group, then the next Grouped object, and so on. Objects not part of a group are treated as being in a group together.

#### ORDER BY PRIORITY

If you choose Order By Priority, the cut planner will apply all remaining optimizations to the objects with the highest priority (Assigned in the Shape Properties Window) first, then the next lowest and so on.

#### Optimizations

These optimizations are applied to each cutting set of outputs from the above ordering as a set.

#### CUT INNER SHAPES FIRST

As the name implies, if there is an object within another object, and both are being cut, it will cut out the inside object before the outside one.

#### CUT IN DIRECTION ORDER

This will try to cut the shapes in your project in the specified direction - top to bottom, left to right, etc.

#### REDUCE TRAVEL MOVES

This will have the cut planner try to order the cuts in a way that it will choose objects beside each other to try and reduce non cutting travel moves.

#### REDUCE DIRECTION CHANGES

The cut planner will try to choose nearby cuts that allow it to keep moving in the same direction, which keeps the laser moving faster.

#### HIDE BACKLASH

This option is similar to the 'backlash repay optimize' setting found in RDWorks - It produces a cutting order that reduces or eliminates the misalignment between the start and end

points of a cut caused by loose or flexing belts, or other forms of play in the mechanical parts of the laser. Enabling this option will force some of the other options to give it the most flexibility when planning the cutting path.

#### **CHOOSE BEST STARTING POINT**

Allows the system to start a cut at any point within a shape, not just the first point. Works best when "reduce travel moves" is also enabled.

#### **CHOOSE CORNERS, IF POSSIBLE**

The cut planner will attempt to start a cut at a sharp corner to minimize burning or staining on the surface of an item.

#### **CHOOSE BEST DIRECTION**

The cut planner will attempt to choose the best direction to cut in.

#### **REMOVE OVERLAPPING LINES**

The cut planner will remove lines that overlap each other that would cause the laser to cut in the same place twice. This will remove any line fully covered by another line, but will not yet remove partial overlaps, like this:

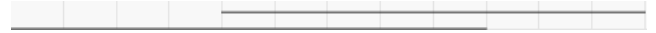

(the lines are offset from each other slightly here to be able to see them)

## 4.6.2 Cut Shapes Tool

The Cut Shapes tool in LightBurn allows you to cut vector shapes in a project using a closed shape as the cutting tool. It is intended for cutting a project into smaller sections that can be run separately, allowing you to create projects that are larger than will fit within the area of your laser. Large scale designs make heavy use of this feature. (1)

1. Cutting a single project larger than your laser: [https://www.youtube.com/watch?v=n\\_saOKVupA](https://www.youtube.com/watch?v=n_saOKVupA)

To use the Cut Shapes tool, select the shapes you wish to cut, then add the cutting tool shape to your selection (the last shape selected is the cutting tool). In the Tools menu, select 'Cut Shapes' and the software will perform the cut.

An example is shown below - the black oval is used as the cutting shape, and the result is shown on the right, separated so you can more easily see the cut line.

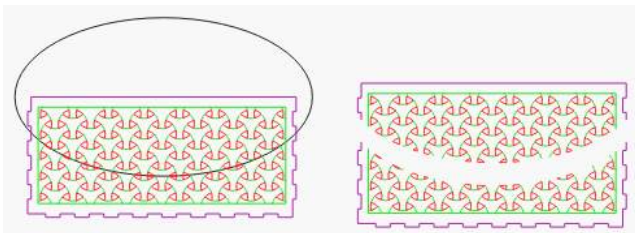

In this zoomed in view, near the lower-left you can see that when the red shapes were cut, the software added a new line, closing those shapes, but did not add anything when the green lines were cut. This is because the red layer is set to 'Fill', and in order for the resulting shapes to fill correctly, they need to be closed. The green layer is set to 'Line' mode, so those shapes are not closed when cut.

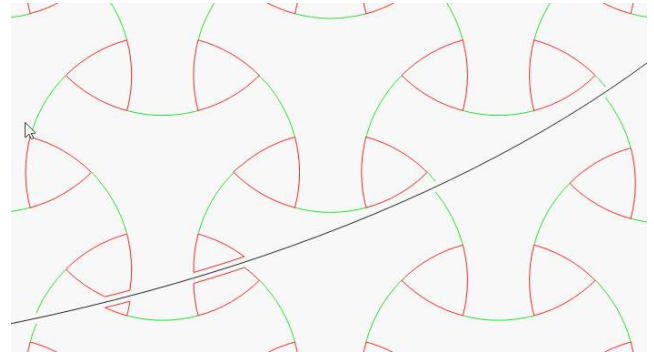

Key points to remember:

- The last shape you select is used as the cutting tool
- The shape used as the cutter *must* be a single closed shape
- The cutting tool shape is discarded - if you need it again, make a duplicate of it (Ctrl+D)
- Shapes that are cut will be closed if they are set to 'Fill', or left open if they are set to 'Line'

### 4.6.3 Print and Cut with LightBurn

"Print and Cut" normally refers to the ability to print a design on a printer, then have it automatically cut it out with a blade or laser cutting machine by using registration marks on the print to align the cut to it.

Print and Cut in LightBurn is used to align your current project to something you've previously output. The most common use for this is, as above, printing a file with a design on it and then using the laser to cut out the design, but it can also be used to align multiple jobs on your laser.

You can use it to register two halves of a large job with each other, for example, to cut something larger than your machine. We have a tutorial that shows how to do this here: [Cutting a single project larger than your laser](#)

You can also use it to register multiple passes over the same job - For example, you could use your laser to lightly engrave an outline, remove it from the machine to paint it, then put it back in the machine, align it using Print & Cut, then engrave a different area in the same project.

**Note:** In order for the output to be positioned correctly on your laser, you *must* use *Absolute Coords* as the positioning mode, otherwise the output will not match the position of the print.

#### Registering a printed file with a laser cut job:

As an example, take this design, printed on sticker paper:



I've imported the same design into LightBurn, with the cross-hair markers, and added an outline to the dragon using the offset tool:

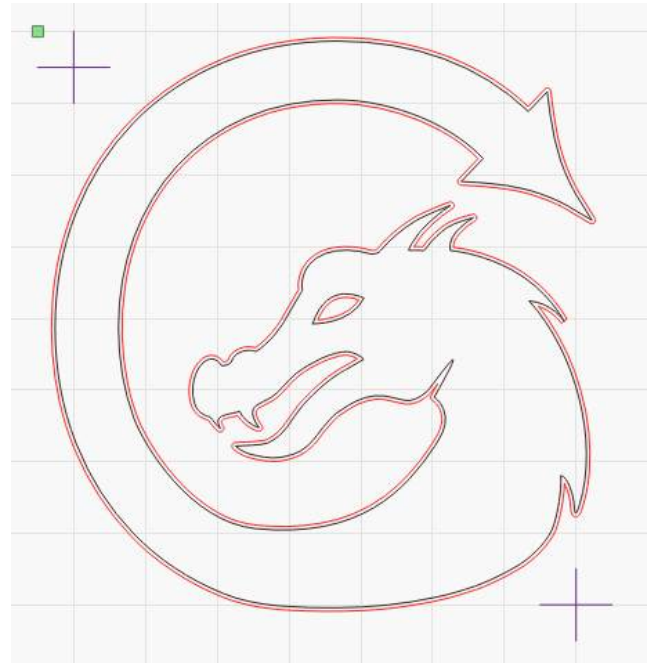

The important part in this file is the two cross-hair marks - these are the target marks that you will use to align the cutting path with the printed sticker. They don't have to be cross-hairs, but these are simplest to align with, as the *center* of the selected object is what is used for alignment when recording positions. Each target marker must be a *single* object that can be selected - If you draw two lines to make a crosshair, group them.

The red lines are set as cut vectors, with an appropriate power and speed, and the black lines can either be set not to output, or simply deleted.

After placing the printed version of the file in the laser, follow these steps to align the laser output with the print.

Note: There is now a wizard for Print and Cut that will guide you through the steps below. You can start the wizard by clicking Laser Tools > Print and Cut > Start Wizard, shown here:

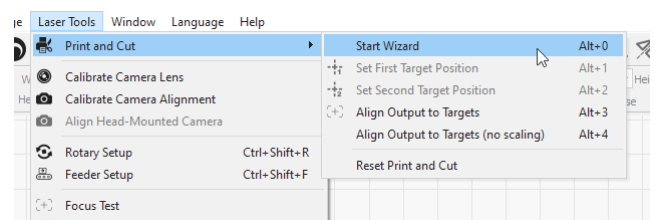

You'll be presented with the Print and Cut wizard, shown here:

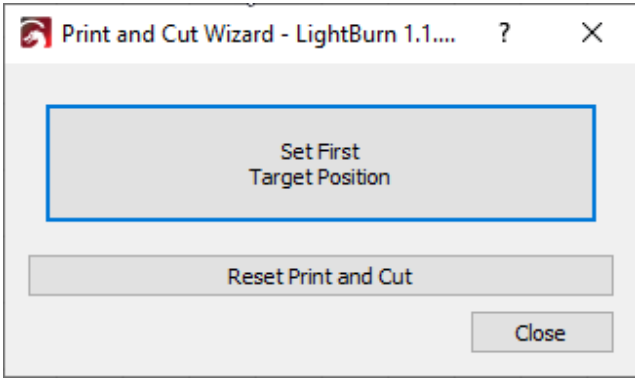

Or, you can do the steps using the menu items instead.

Using the red-dot pointer of your laser, jog the laser head to align with the center point of one of the two cross-hair marks. You cannot move the laser head by hand for this - you have to jog the laser either with the buttons on the laser control panel, or in the Move window in LightBurn.

In LightBurn, select the same cross-hair mark, then go to Laser Tools > Print and Cut > Set First Target Location, like this:

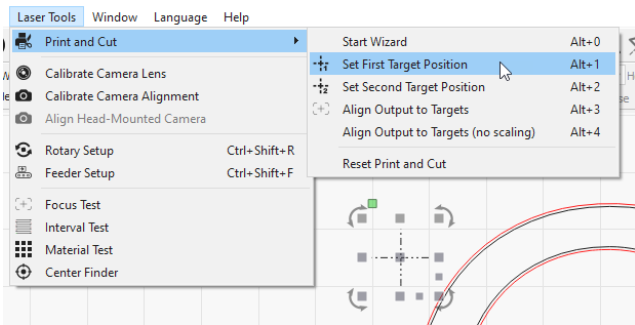

Now, jog the laser to align the red dot pointer to the center of the second marker.

In LightBurn, select that second cross-hair mark, and again choose Tools > Print and Cut > Set Second Target Location:

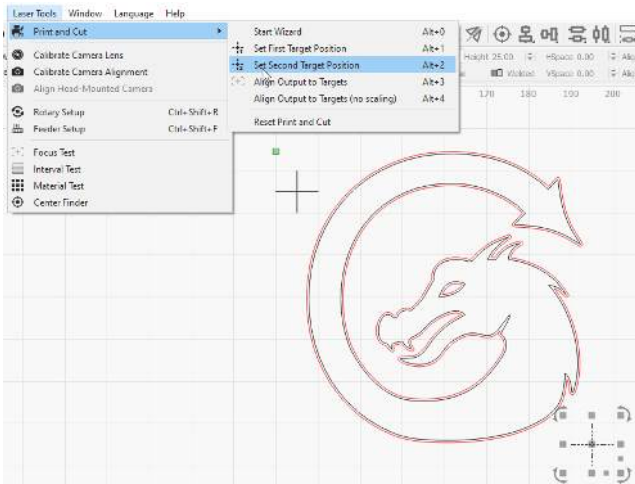

You will notice that in the above image, the menu option for 'Set First Target Position' has the icon highlighted as well - this means that the First Target Position is set and active.

After setting both targets, the menu will automatically enable the 'Align Output to Targets' option for you, like this:

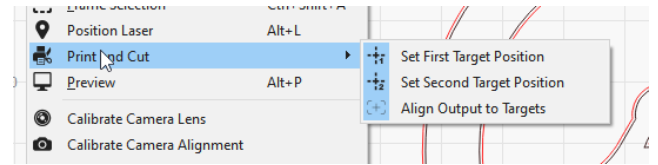

You will also see the "(Print & Cut mode)" message in the status window, like this:

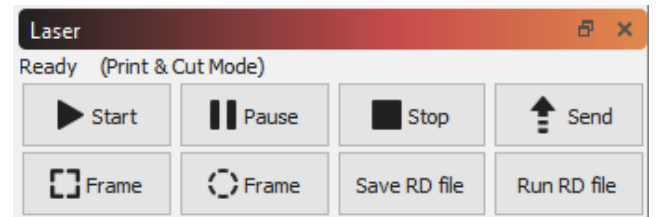

If you preview at this point, the orientation of the preview should match that of the print on your laser:

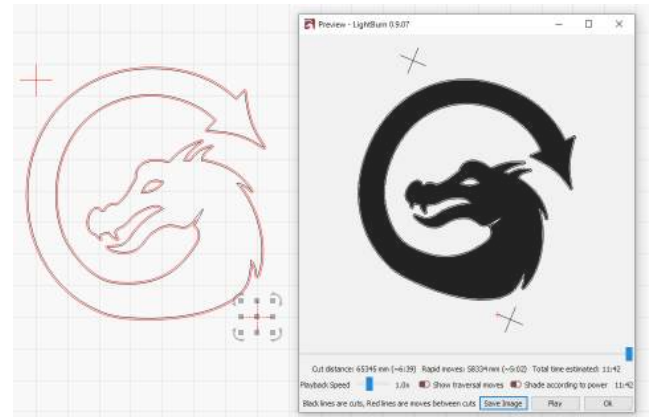

In the above image, you can see the preview image is rotated slightly clockwise, matching the orientation of the printed image in the laser.

**Note:** In order for the output to be positioned correctly on your laser, you *must* use *Absolute Coords* as the positioning mode, otherwise the output will not match the position of the print. The accuracy of the result will be affected by the accuracy of your red-dot pointer, so using one that is either a cross-hair beam pointer or a red-dot marker that is in the same beam path as your laser is ideal.

After running the job on the laser, this is the result:



When finished, you can turn Print & Cut off by un-highlighting the 'Align Output to Targets' option:

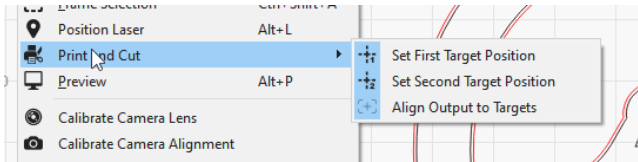

That will turn off the Print & Cut mode.

#### USING SHARP CORNERS IN YOUR FILE INSTEAD OF TARGETS

The Print & Cut feature measures the difference in position, orientation, and scale between the two positions you mark with your laser and the corresponding positions you select in the software. You do not actually *need* to output the markers in LightBurn, they simply need to exist so they can be selected.

The sticker image shown above has a very sharp corner at the tip of the tail, and one on the lower jaw - These would be acceptable locations to use as alignment targets as well, which would allow you to register to a job even without visible registration marks:

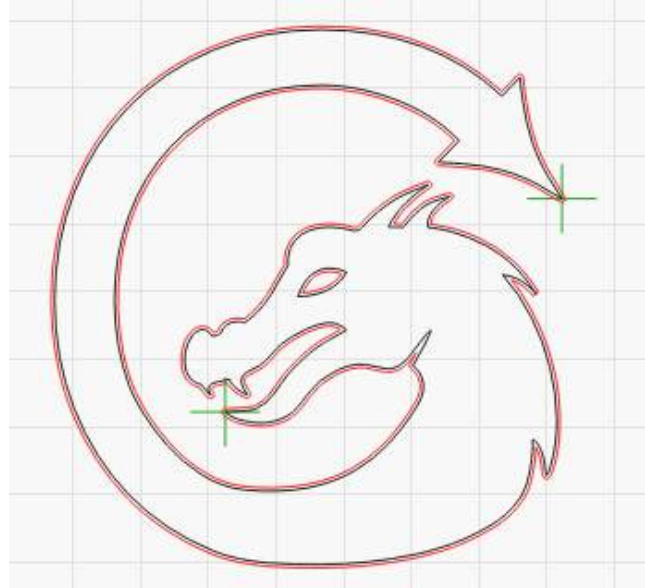

By putting the markers on the green layer, then setting that not to output, they're available in LightBurn to select, but wouldn't be part of the actual cutting job sent to the laser. When aligning to the first target, you'd point the red dot at the tip of the tail, and in LightBurn select that marker. Then repeat the process by pointing your red dot at the tip of the lower jaw, and select the marker in that location in LightBurn.

## 4.6.4 Rotary Setup (DSP)



This will walk you through setting up and using your rotary attachment with LightBurn for gantry (non galvo) lasers. For that overview, please see [here](#).

In the top menu bar, click the Laser Tools menu (or just Tools in older versions of LightBurn), then Rotary Setup, and it will open the rotary setup window, shown here:

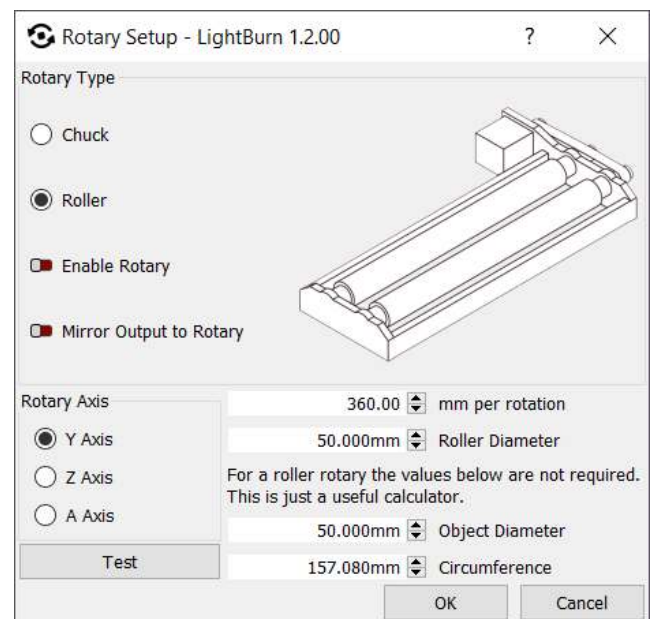
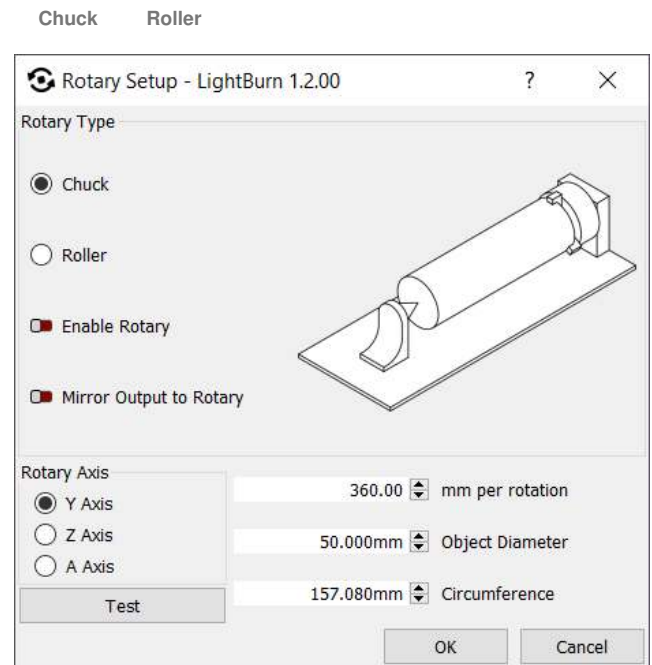

The window may look different depending on the type of controller you have, and in fact, you may not be able to access this menu item at all - most Trocen controllers, for example, require setting rotary parameters through a menu on the controller panel itself.

## General Rotary

- Choose whether you have a chuck style or roller attachment.
- Click the enable rotary check box (it will turn green when enabled).
- In the steps per revolution box, enter the number of steps it takes your attachment to make one full revolution. For a chuck rotary, this will be one rotation of the chuck, and for a roller, it will be one full rotation of the roller, NOT the item. For GCode devices with a dedicated rotary axis, this number should just be "360 degrees". If not using a dedicated rotary axis, you'll have to use trial and error to dial in the correct travel distance using the *Test* button.
- Click the *Test* button to verify that the roller or chuck makes one full rotation, pauses, then returns.
- Enter either the diameter of the object to be engraved or its circumference, the other value will be automatically calculated.
- Align your object under the laser head in a position where the X axis will start and rotate the object in the rotary attachment to the point where you want the Y axis to start engraving.
- When using the rotary, it's generally a good idea to use "current position" as the "Start From" setting.
- Click Start to run your job, or if you have a DSP controller, you can use Send to send it to the controller to run it from there.
- **Remember to uncheck the use rotary attachment check box once you are finished** so that you do not mess up your next regular project.

## Notes

- If the object slips on the rollers of a roller type attachment, wrap the rollers with some sort of non-slip material or even rubber bands.
- You can also try placing some weights inside the object such as ball bearings or other small round objects, this will help press the object against the rollers.
- **If you end up with a flat part at the 'bottom' of the engraving**, it means your rotary gear mechanism has backlash. In general, tightening any belts in the rotary device will fix this, but if not, you can place a small line a few mm below the bottom of your design, set to very low power, like 0.1%, and set it as the first layer to run. The rotary will spin to this position, then back up over that few mm of gap, and will take up the backlash with that movement.

## DSP Specific Setup

If using a Ruida controller, disconnect the Y axis stepper connection and connect the rotary attachment to the Y axis. If using Smoothie or Grbl, C3D, or Smoothieware controllers, click the "A" axis selection. (See below on how to configure your controller steps before you proceed).

### Note

If you are using a DSP controller (Ruida, etc), when you change the rotary setting you need to power-cycle the controller, as some of the internal logic isn't adjusted for the rotary setting unless you do this. Change the setting, close the Rotary Setup window to write the change to the controller, then power off the control board and power it back on. You will likely need to press the Esc (or stop) button on the controller to prevent it from trying to home itself, as the Y axis will not home properly.



## 4.6.5 Scanning Offset Adjustment

Modern lasers are capable of moving very fast, and with remarkable precision, however firing the beam still takes time. Some power supplies and tubes may respond in microseconds, but others take longer. At higher speeds, belts will pull slightly as well, and all of these things can cause the output of the laser to shift slightly when engraving.

At 100 mm/second, 254 dots per inch means your dots are 0.1mm in length, fitting 1000 of them in 100mm. At 100 mm/sec, if your power supply and tube take 1 millisecond to fire, your engraving will be offset by a full dot width.

At 500 mm/second, that 1 millisecond delay means you'll be off by 5 dots, or 1/2 a millimeter. Still not very much, but visible. Adding a bit of mechanical stretch to this will increase the offset.

The result often looks like ghosted edges. The image below is a 20mm square at 1000 mm/sec, with a 1ms delay, resulting in a full mm of skew between scans:

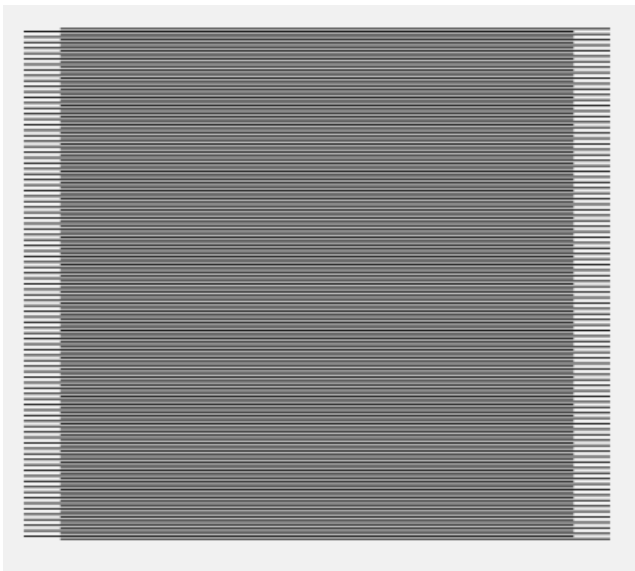

LightBurn has a setting to counter this, called Scanning Offset Adjustment, in the **Device Settings**. Other software may refer to it as 'Reverse Interval' or 'Reverse Compensation':

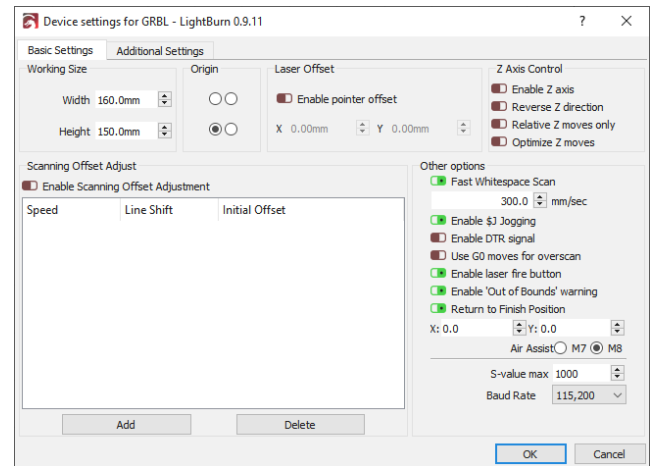

To use this feature, you need to measure the response of your machine at a couple of different speeds. Create a small rectangle in LightBurn, 50mm wide and 10mm high, set it to scan, and set the interval to 0.5mm. If you are on a GCode based device, enable overscan, and set it to 5% or greater to be sure the machine is not slowing down before reaching the ends. (Ruida devices overscan automatically). Note that in the image below I have power set to 0 - Don't do this. You will need to set the power high enough to mark your material.

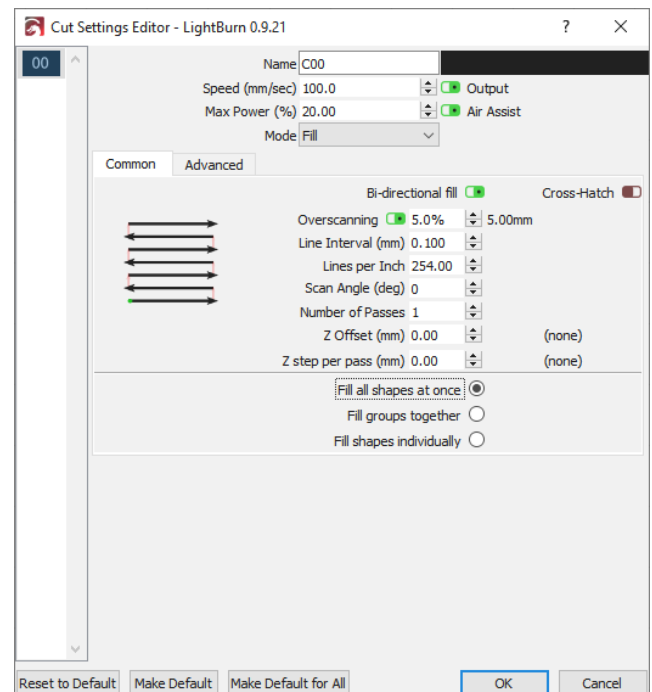

Run this rectangle at multiple speeds, like 100mm/sec, 200mm/sec, 300mm/sec, and so on. Depending on your hardware you may not even need to use these settings, however here is example output from a machine that does:



To compensate for this, measure the distance between the ends of the lines at each speed, and enter the speed and distance values into the scanning offset adjustment table. LightBurn will use this information to compute the correct adjustments for other speeds as well. A minimum of two measurements are needed for it to work. **Note** you will need enter *half* the measured value - The software moves each line by the amount you specify, so each pair of lines only needs to move half the distance.

There is an excellent tutorial online at Cartonius.com here: <http://cartonius.com/how-to-improve-engraving-quality-of-laser-machine/>

You may need to do this multiple times, making minor adjustments to get clean results at each speed. After entering the measurements for the above speeds, the resulting corrected output looks like this:

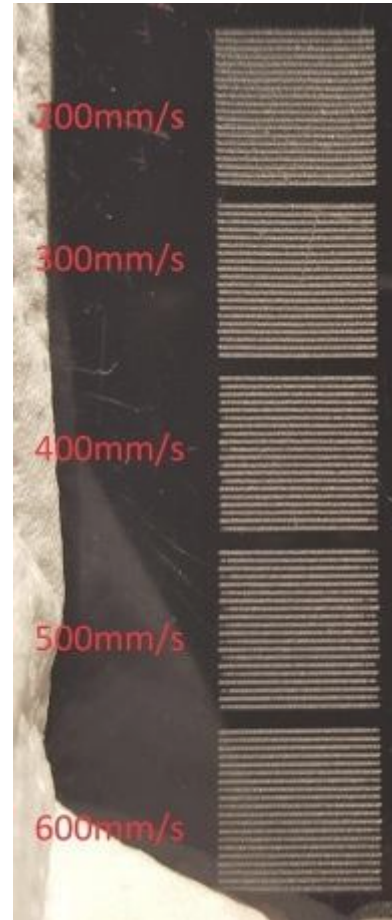

#### 4.6.6 Line Wobble

A different, but equally common problem, is line wobble, often caused by too high an acceleration setting. When doing the test cuts above, you may notice lines that look like this:

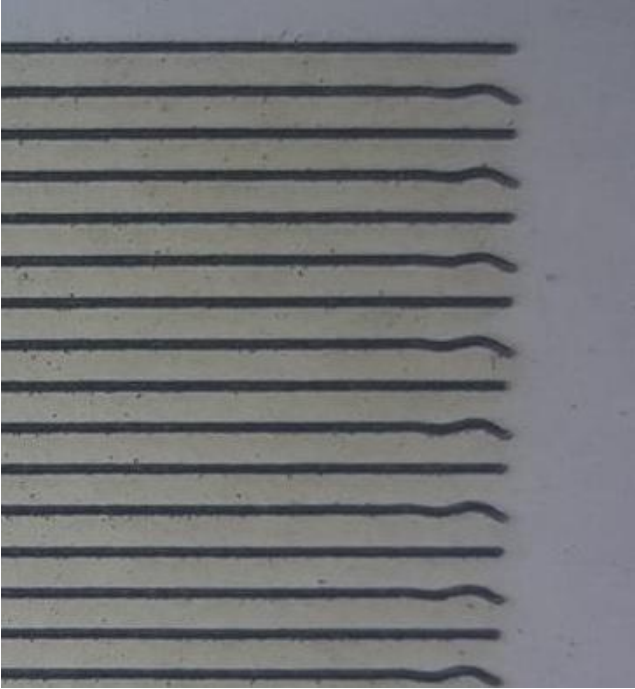

If so, your machine is moving too quickly between the rows, and you're seeing physical "bounce" in the gantry because of it. Lowering the acceleration setting for your Y axis can correct this.

Advanced DSP GRBL Galvo Tools

## 4.6.7 Using A Camera

Using a camera with LightBurn allows you to use a USB connected camera with LightBurn to:

- Position designs on material
- Trace simple artwork from the camera image
- Monitor your laser

In LightBurn, enable the 'Camera Control' window by going to the Window menu and selecting it. You'll see a window that looks like this:

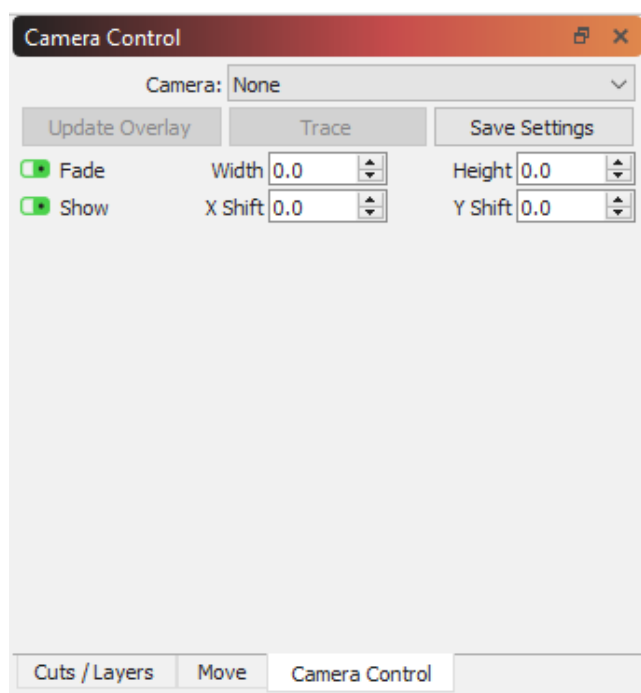

If your computer has a compatible USB camera connected, it will appear in the Camera drop-down box. Select the camera, and the view from the camera will appear in the window, as shown:



LightBurn only supports the use of UVC-compatible cameras. As such, some software cameras (such as OBS Studio's "Virtual Camera") may not present as a camera at all to LightBurn, or may render incorrectly.

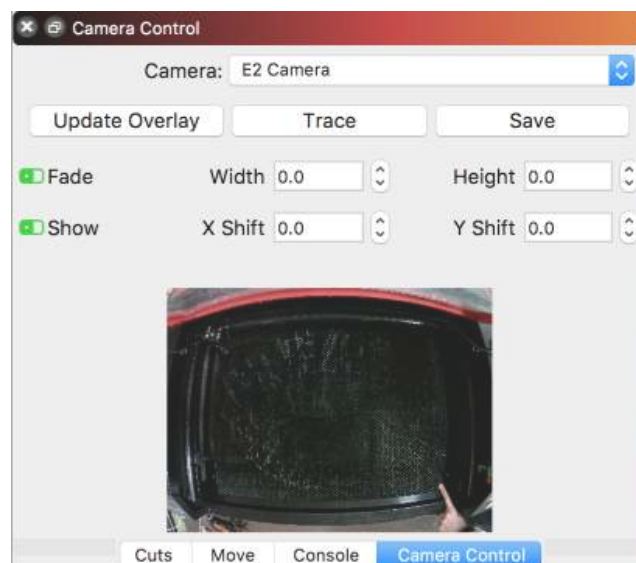

This image is fairly distorted, because the camera used here has a fish-eye lens. LightBurn will correct for this, as well as mounting at odd angles, and will simulate a clean, top-down view of whatever is on the bed of your laser. It takes a bit of effort to set up, but it's worth it.

### Mounting and Focusing

If your machine already has a camera installed, you can skip this part. If you are installing the camera yourself, there are a few key things here worth noting.

- The ideal mounting position for the camera is directly above the center of the bed of the laser, with the bed completely in view (similar to the image shown above). We generally recommend mounting on the inside of the lid, when opened, like this:

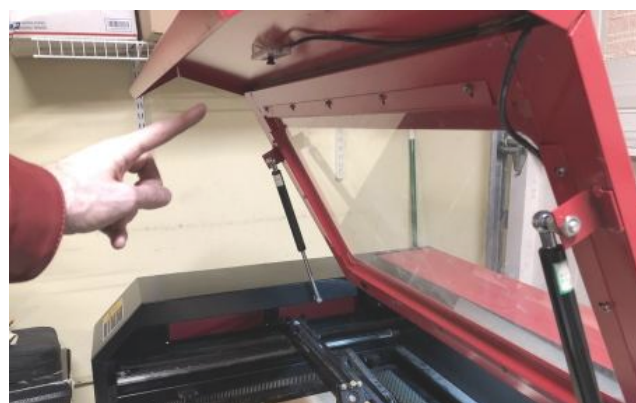

- The camera should be focused as well as possible. Most LightBurn cameras are manually focused by twisting the lens.
- The camera must be solidly mounted such that it is always in **exactly** the same position when using it, relative to the work area of your laser, and the top of the material. If you mount to the lid of your laser, make sure the lid opens to the same place every time - gas struts

have a bit of play in them, so using a cord or rod to ensure the lid is always at the same position when opened can help.

- If your camera is in a mount, make sure it does not move within the mount. A small piece of EVA foam or even tissue can hold the camera securely in the mount.
- Make sure that wherever you choose to mount the camera that it is out of the path of the laser head, and that you run the cable so it is not in the path of the beam. Ramming the laser head into your shiny new camera is a great way to increase your blood pressure.
- Focus the camera so as much of the bed is in focus as possible. Some cameras, like the 5mp-60, have a narrow focus depth, and if mounted high, can be tricky to focus. If this happens, focus on a circle that is roughly half-way from the center of the bed to the edge of the image, like this:

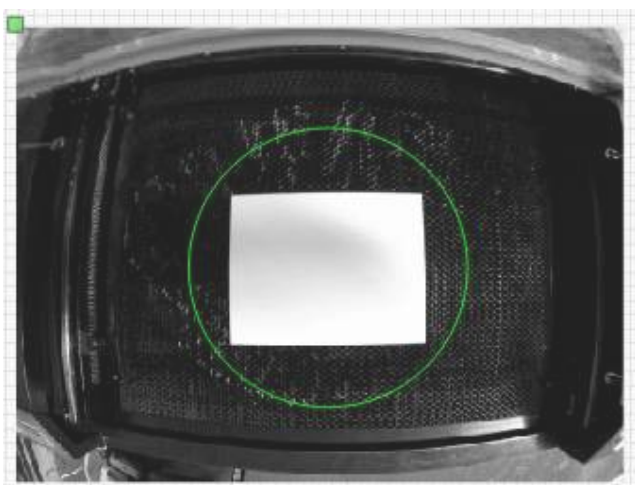

#### Note

Cameras used with LightBurn should plug in to your computer as directly as possible; use of an active USB 2.0 amplifier to extend the distance may work, but is not guaranteed. Do not connect your USB camera to any USB port on your laser. USB 2.0 has a native max length of approximately 16 feet. (5 meters).

#### Warning

The camera system depends on the camera being in the same position relative to the work area of your laser *and* the same distance from the top of the material. If your laser uses a variable *focus distance* instead of a variable height *work table*, you will need to align for the material height you are using.



To use LightBurn's camera functionality, you must use *Absolute Coords* mode, so LightBurn can accurately position the work. If you use an older Trocen controller, they do not allow setting this mode from software, so you must change the working mode through the controller menu.

## Choosing A Camera

The best choice of camera for a given machine depends on a couple factors:

- The size of the working area of the machine
- The height above that working area that you mount the camera

LightBurn can help make the decision. Open the "Help" menu in LightBurn and choose "Camera Selection Help". LightBurn will use the size of the selected laser's work area and the information it knows about our cameras to show a list of the minimum mounting heights for each camera we sell, like this:

Camera	Aspect	Camera sees	Minimum mounting height
5mp - 60	1.333	600 mm x 450 mm	727 mm / 28.63"
5mp - 90	1.333	600 mm x 450 mm	429 mm / 16.87"
5mp - 120	1.333	600 mm x 450 mm	400 mm / 15.75"
5mp - 140	1.333	600 mm x 450 mm	333 mm / 13.12"
5mp - 160	1.333	600 mm x 450 mm	222 mm / 8.75"
8mp W - 95	1.778	711 mm x 400 mm	474 mm / 18.66"
8mp W - 110	1.778	711 mm x 400 mm	296 mm / 11.67"
8mp N - 75	1.333	600 mm x 450 mm	500 mm / 19.69"
8mp N - 120	1.333	600 mm x 450 mm	286 mm / 11.25"

Double-click an entry above to visit the product page for it on our website.

Note that the mounting height is a **minimum** and you should allow some extra space. It assumes the camera will be mounted directly above the center of the work area of the laser.

Choose the camera with a minimum mounting height **less than** the height you plan to mount it.

OK

The image above shows the minimum mounting heights for all cameras, given the size of the machine entered at the top. Choose a camera that needs about 50mm (2") **less** than the distance from your laser bed to the mounting location, just to give you a bit of room for adjustment.

## Camera Calibration

Camera lenses are not perfectly flat, and "distort" the image that the computer sees. For reliable placement of your workpiece using the camera, calibrating the camera is a *must*.

In the "Laser Tools" menu, open the "Camera Lens Calibration" wizard.

You will need to download and print the following image:

[Calibration-Circles.png](#)

The circles image will be approximately 148mm x 105mm (5.8" x 4.1"), and should have at least 6mm (1/4") of white space around the pattern.

Mount it to stiff cardboard, foam board, or wood, so the image remains very, very flat. If the image is curved, it will not work to calibrate the

#### THE CAMERA LENS CALIBRATION WIZARD

Camera Lens Calibration uses series of captured images of a known pattern. The software analyzes how the pattern appears in the images, and compares that against its internal knowledge of how the pattern should look. It determines the amount and shape of distortion produced by the lens of the camera, and computes an inversion for this distortion.

**Note:** This process is dependent **only** on the camera and lens, not on its placement in your machine - as long as the camera and calibration pattern are perfectly still, you do not need to mount the camera in the machine to perform the lens calibration. If the calibration image cannot be held at the appropriate distance to match the shown image in the display, you may shrink or enlarge the printed pattern.

**Important:** If your machine has a honeycomb bed, or something similar to the image below with a lot of visible circles, it will likely be necessary to cover it with something. The pattern finder is looking for circles, and if it finds anything that looks like thousands of them, it gets confused.

It is best to have good, consistent lighting for the capture process, and the camera should be in focus. A fuzzy image, or shadows falling across the calibration pattern will make the process much harder, if not impossible.

Open the "Tools" menu and choose "Calibrate Camera Lens" from the menu. You will be presented with a screen like the one below.

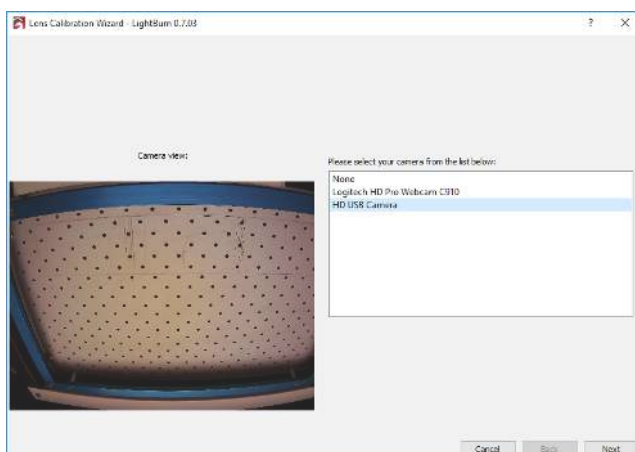

Choose your camera in the list, and you'll see the view from the camera in the area to the left. With the correct camera selected, click Next.

The view will change to include a capture button, and a helper image to show you how to position the printed pattern for capture. For the first capture, place the pattern in the center of the field of view of the camera, with the printed face of the card pointed directly at the camera, as

shown in the small view up top. If you cannot easily match your capture image with the suggested image, you may need to adjust the scale of your printed card, or leave the camera out of the machine for lens calibration.

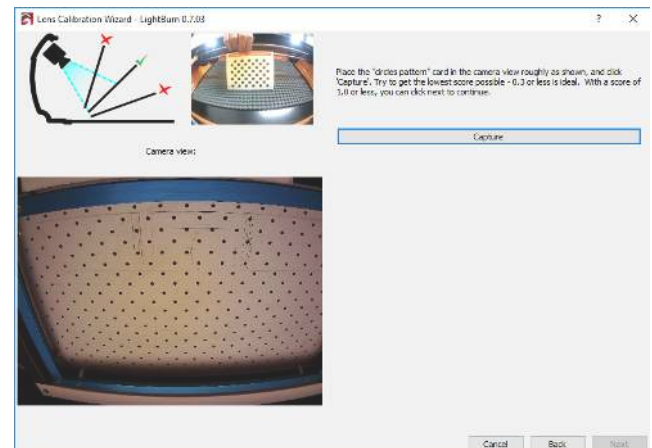

Click the Capture button (highlighted above) and you should see something like this: (note that we've removed the camera from the machine for this one)

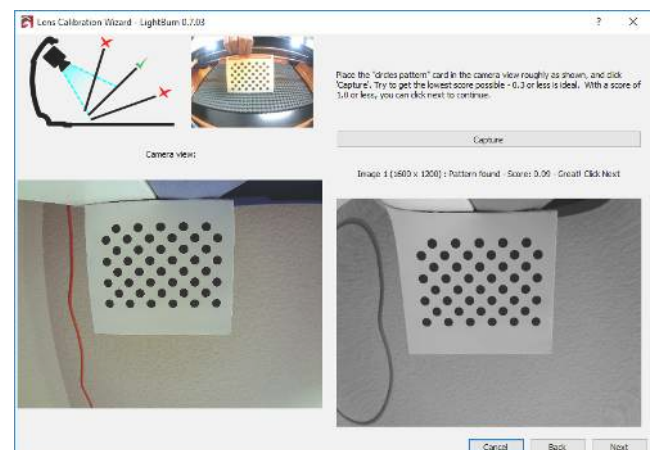

Above the image on the right you see:

Image 1 (1600 x 1200) : Pattern found - Score: 0.09 - Great! Click Next

This tells you:

- The image was successfully captured
- The resolution of the captured image is 1600 x 1200 (higher is better)
- The calibration pattern was found in this image
- This image scored very well - Lower scores are better. In this image, after distortion removal, the positions of the dots in the image align with the positions of the real dots with an average error of only 0.09 pixels - That's very good, and well within our desired score of 0.3 pixels of error.

Notice that in the gray image that appears to the right, the pattern of circles is not distorted, though the image around them is considerably worse (look just above the dots). That is temporary, and the result of only having a single calibration image to work with. As you progress through the

remaining calibration steps, you'll capture more images with the pattern in different parts of the camera view, filling in more information about how your lens distortion affects the image.

If the calibration pattern is not found, LightBurn will tell you so. Make sure the pattern card faces directly toward the camera, and occupies roughly the same amount of view area shown in the "suggestion" image. The pattern card should be parallel with the sensor of the camera, as shown in the upper-left graphic in the capture window, though the pattern can be rotated within the view without affecting the calibration if this is easier, as shown here:

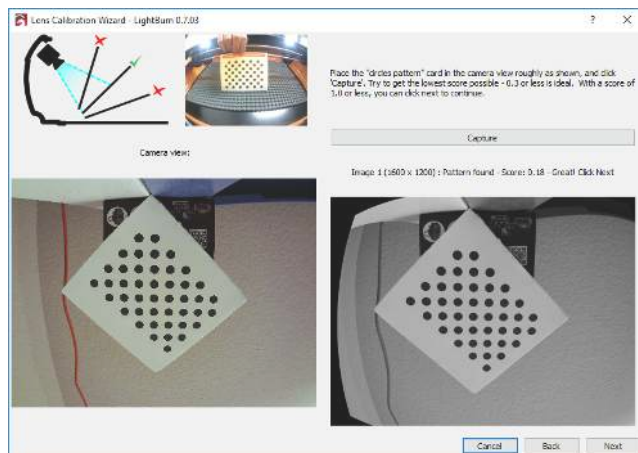

As you advance through the captures, the suggestion image will update. The first five images are the center of view, followed by bottom, left, right, then top. If your camera has a very strong fisheye effect, it may be necessary for you to move the non-center images inward a little to get a successful capture. This is ok.

The final four images are the corners, and these can be difficult to capture with high-distortion cameras. If your first 5 images score very well (below 0.3) you are allowed to skip the final four images (the 'Next' button will show as 'Skip' in this case). If you are having trouble capturing the last four images and don't have the option to skip, you can place the card anywhere within the view and capture that instead - We don't verify that your placement matches what we're suggesting.

Even after only a few good captures, the image on the right should appear to be free of lens distortion, as shown here:



A poorly calibrated result will still show lens distortion, and may have other artifacts, like the "wobble" seen in the lower-left of the gray image below:



If you don't get it straight away, you can re-capture the current image, or just go back to the beginning and try again. It can take a few tries to get a feel for how to align the card with the camera to get the lowest score.

When you have advanced through all the steps, and you are satisfied that you have a good calibration result with a nicely undistorted image, click Finish to save the results. You can also click the "Align Camera" button in the final page to take you to the next wizard automatically.

### Aligning the Camera and Workspace

Now that the camera is calibrated, you can move on to the next step, camera alignment - telling LightBurn where your camera is in relation to the workspace of your machine. From this step forward, it is very important that the camera not move in relation to the machine. It is possible to mount the camera to a movable piece of your laser, like the cover, as long as the position of the camera is the same when you use it as it is when you calibrate the alignment. The camera should be firmly mounted pointing at the center of the machine work area, with a clear view.

#### CUTTING THE ALIGNMENT MARKERS

In the Tools menu, choose "Calibrate Camera Alignment" to start the alignment wizard. Choose the same camera you did in the Lens Calibration wizard.

After selecting the camera and verifying that you can see an image from it, click Next and you'll get to this screen:

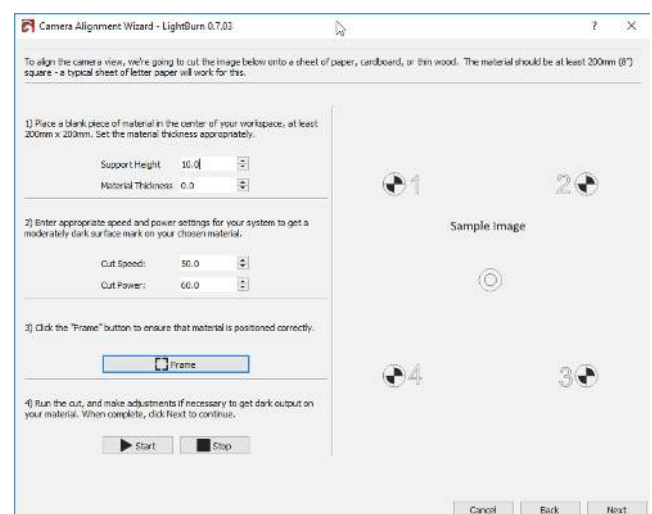

This page uses your laser to cut a target pattern onto a piece of material, such as card stock, paper, cardboard, or thin wood. The pattern that will be cut is shown on the right side of the display.

LightBurn supports many different types of laser, so we need you to specify how fast and at what power to do this cut. You should choose settings that will make a dark surface mark on the material, but not cut through it. The "Support Height" and "Material Thickness" values can be set to zero if you do not normally use these values when cutting.

Follow the directions in order - set the numbers appropriately, use the Frame button to check that the material is aligned with the cut, and click Start when you're ready. If the cut comes out incorrectly (too light, or too strong) change the settings and try again. Your results should look something like this:

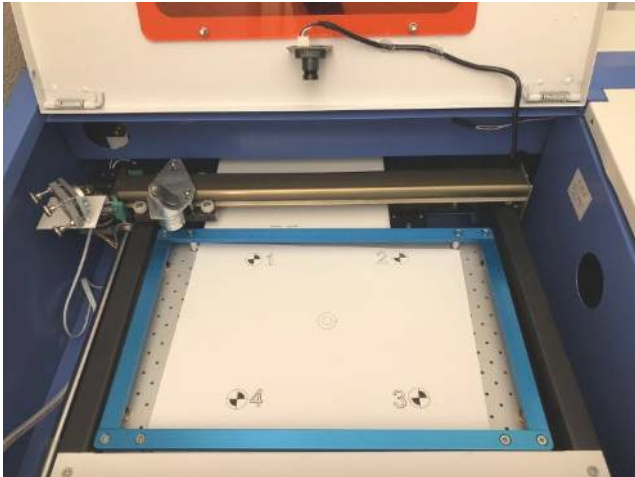

When you have a good result, click next.

#### CAPTURING THE TARGET MARKER IMAGE

From this screen, you're going to capture the alignment image. *It is very important you do not move the target marker image after cutting it.* Use the jog or "send to corner" buttons here to move the laser out of the view of the camera. When the camera has a clear view of all four targets, click the Capture button. You should see an undistorted version of the camera view appear in the right side of the window, with all four corner targets visible, as shown below:

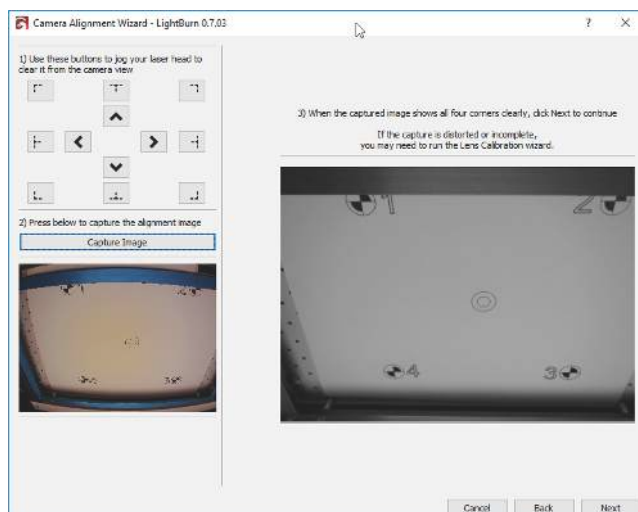

#### MARKING THE TARGETS

On this page you 'tag' each of the targets by double-clicking in the center of each one in order. You can pan and zoom around the image using the same controls as the LightBurn edit and preview windows. When you double-click, a red '+' mark will appear. Place a marker in the center of each of the four targets, in the order they are numbered (1, 2, 3, 4). If you place one incorrectly, you can double click near it to shift it around, or click "Undo Last" to remove it and try again.



Place each marker as accurately as you can. You can see the ideal placement here:

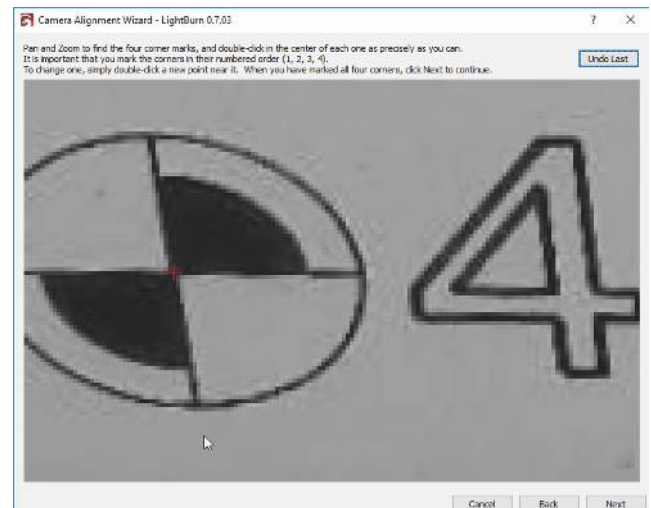

When you have placed all four markers in sequence, zoom back out and verify that all four are visible and clearly centered on the targets, like this:



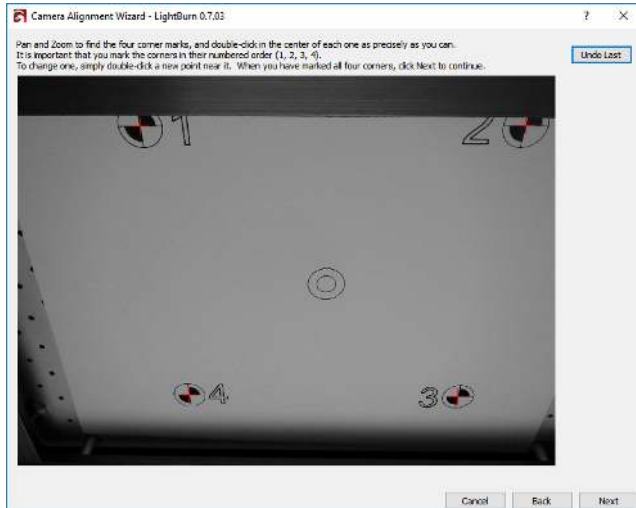

Click Next to finish the marker placement screen and click Finish to complete the process and store the results. You're done!

Now that everything is aligned, open the Camera Control window again, and click "Update Overlay" or use **Alt + C** to capture and project whatever happens to be in the camera view onto your workspace, as shown:

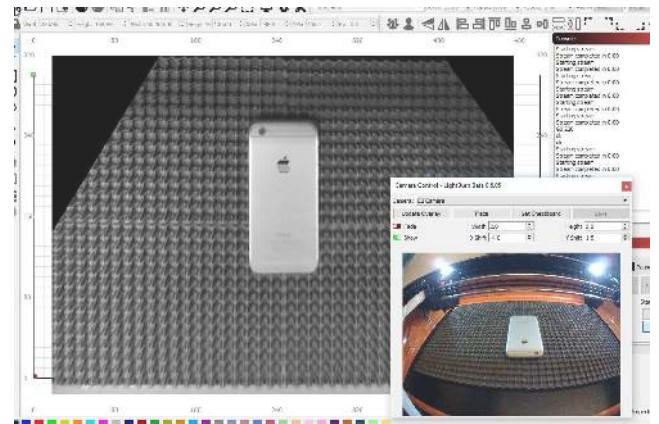

Click the "Fade" button to dim the background image, or the "Show" button to toggle it off and on.

## 4.6.8 Fusion 360 DXF Export

When designing laser cut projects in Autodesk's Fusion 360 the easiest file format to export is DXF. To make sure all the design details we want are present, we'll make a special sketch and export it to get it all into LightBurn.

### Start file

Finish your part and save your file.

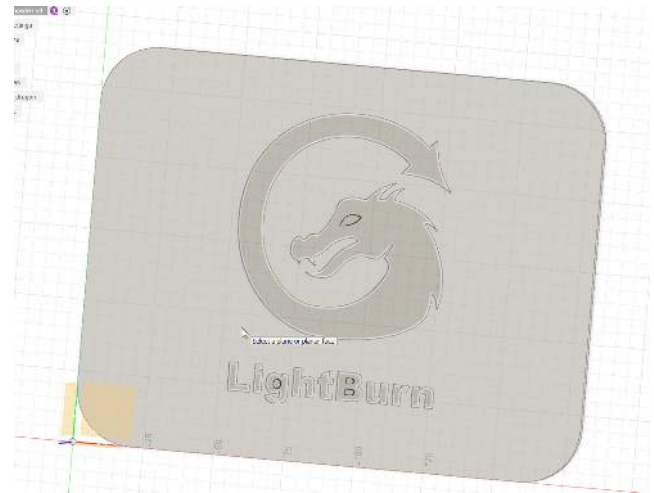

### Project Features

When we select the top surface of the part you'll notice that all the connected features highlight. These are automatically projected and their outlines will automatically get added to the sketch.

We will need to add the eye of the dragon and the inner features of the "g" and "B" from the part. To do this start the *Project* tool from the *Create* menu.

### New Sketch for export

Start new sketch

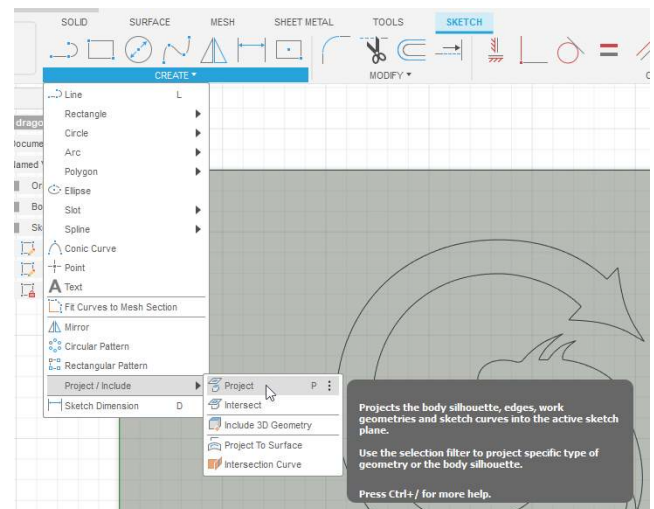
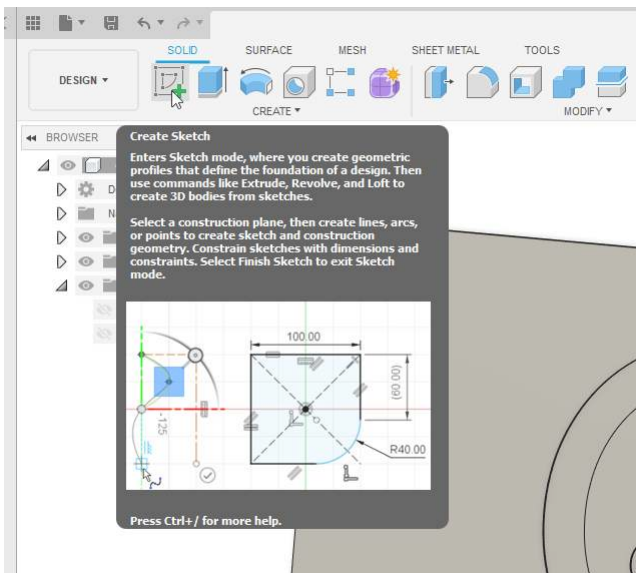

Select the islands in the part and hit *ok* on the project menu and *Finish Sketch*.

and select the top surface of the part



**Check the sketch**

Once you finish the sketch it will be active so you can see the contents.

**Tip**

Turning off the rendered body enables you to ensure that all of the design geometry is selected & ready to be used.



**Save as DXF**

To export the the sketch, Right Click on the sketch you created in the model tree and click "Save as DXF"

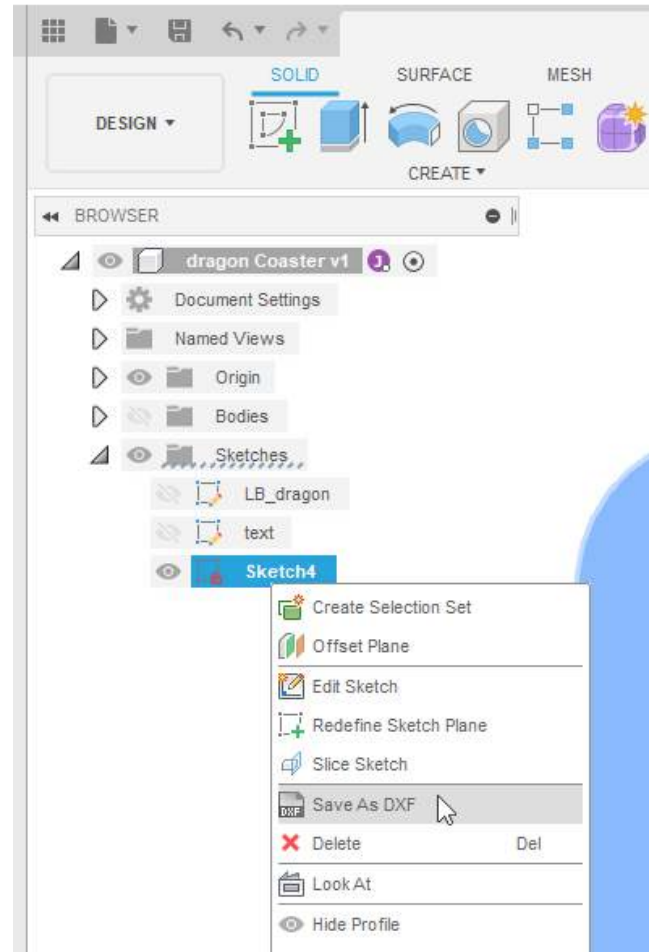

**Check Drawing in LightBurn**

Open up LightBurn with a new file and Click *Import*.

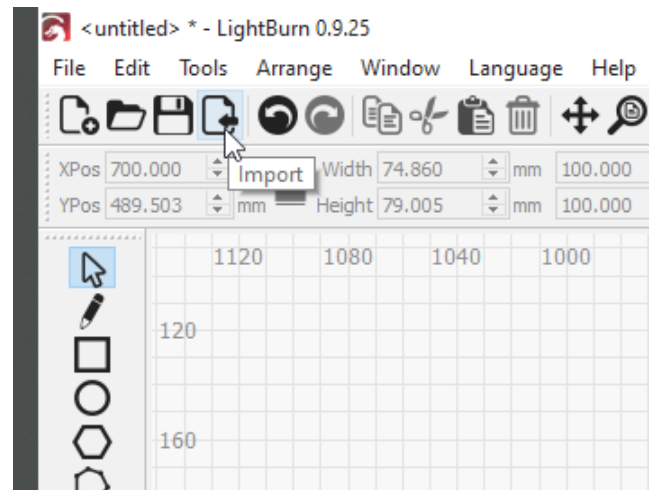

This will bring the .DXF file into LightBurn and the contents will be fully selected automatically.

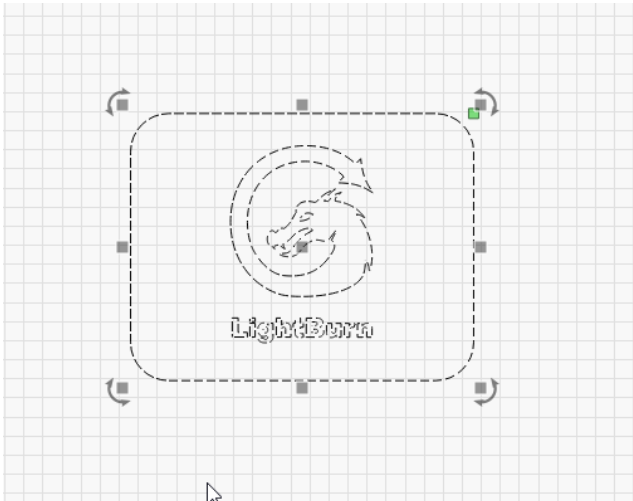

### Checking for Errors or Duplicates

Occasionally you can create duplicate lines using the *Project* tool in Fusion 360. To remove any stray or duplicate lines, select the entire design, ungroup the drawing, and use the **Delete Duplicates** tool in the **Edit Menu**.

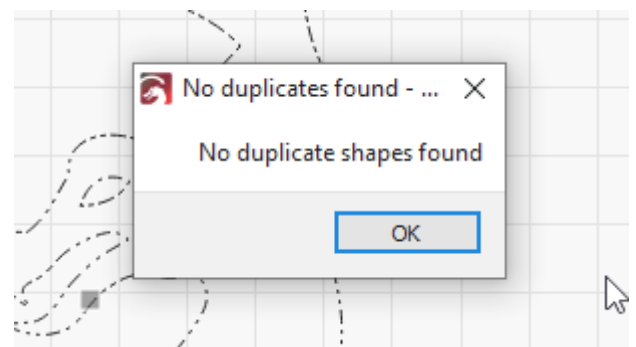
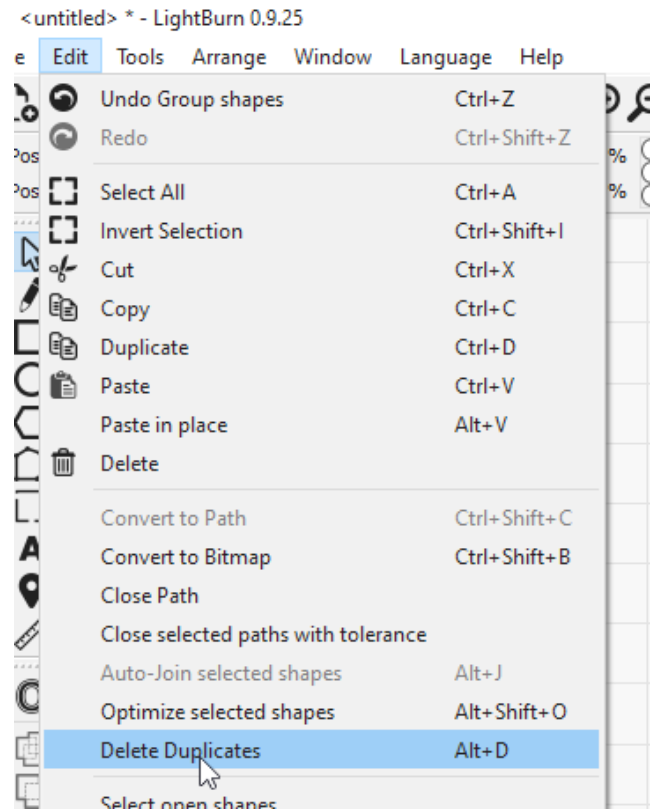
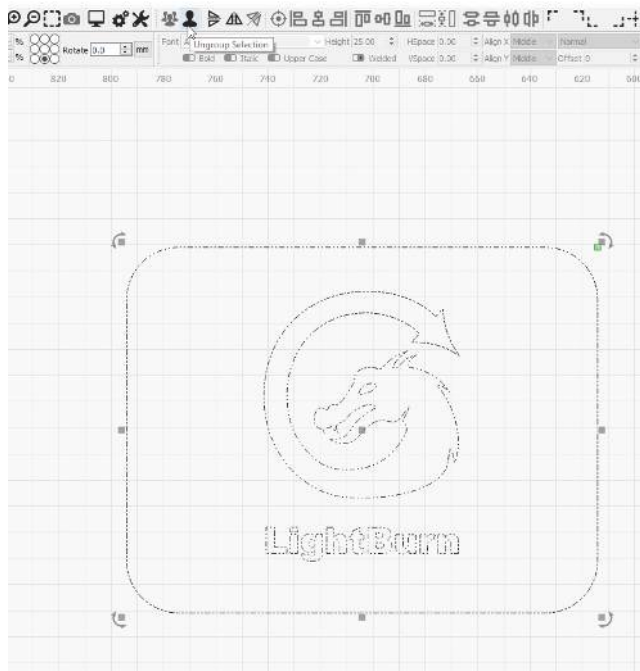

### All Finished!

Your drawing is ready to use!

## 4.7 Troubleshooting

---

### Troubleshooting

#### 4.7.1 Troubleshooting

---

This section will try to cover the most common problems encountered with a few different types of machines, as well as some common issues in LightBurn itself.

Choose the topic that most closely matches your issue:

- [Connection issues](#)
- [Controller error \(GRBL\)](#)
- [Controller error \(Ruida / DSP\)](#)
- [Output to laser is wrong](#)
- [Problem in LightBurn](#)

## Troubleshooting

### 4.7.2 Troubleshooting - Connection Issues

#### Can't connect to the laser

- Make sure you have any necessary drivers installed for your laser. If your machine came with its own software, you might have to install that in order to get the driver for your device.
- A common driver for Chinese diode lasers is this one: <https://sparks.gogo.co.nz/ch340.html>
- On Windows systems, a driver for Ruida and TopWisdom controllers is available at the end of the LightBurn installer - just check the box for the FTDI driver. (See [Installation: Windows](#))
- If you use a Trocen controller, you might have to install LaserCAD to get their driver.
- Make sure you are physically connected to the laser, and have chosen the correct type of laser or controller in LightBurn, and the right connection method.
- Some systems don't automatically connect - you might have to choose the correct port the first time. (See [Connecting to the Laser](#) for details)

#### Losing connection

The most common reasons for connection loss with USB are:

- Poor quality USB cables, lacking shielding or noise suppression. If your laser came with a cable, try a different one.
- USB cable length - USB cables are limited to 16 feet. If your cable is longer than this, it may need an amplifier or

active extension for the signal to remain strong enough to be read correctly at the other end.

- Another device on the same circuit as your laser, like a mini-fridge, air compressor, water chiller, etc. Any of these things powering up may cause a small power drop that can make the laser 'brown out' and temporarily disconnect or reset.
- Poor bonding / grounding - Bonding is tying the various metal parts of a device together, so that if one part builds up a charge, all the other parts build up the same charge. If your laser is not bonded, static can build up on the laser head or rails. If the laser is not grounded (earthed), that static build-up can eventually discharge through the USB connection to the PC, causing comms errors. This is especially common with lasers driven by belts that interact with plastic wheels. Tying the frame parts of the laser to each other, and a ground connection can eliminate this.

#### USB port sleeping

If it thinks a connection is idle, Windows can put the port into a power-save mode, which can make your device stop talking to it. This is especially common with laptops.

If you are having issues where you often lose the USB connection after a period of time, try the following:

Windows 7: [https://pattersonsupport.custhelp.com/app/answers/detail/a\\_id/14917/~/-/disable-power-management-on-windows-7-machines](https://pattersonsupport.custhelp.com/app/answers/detail/a_id/14917/~/-/disable-power-management-on-windows-7-machines) 54

Windows 10: <https://www.windowcentral.com/how-prevent-windows-10-turning-usb-devices> 202

## Troubleshooting

### 4.7.3 Troubleshooting - GRBL

GRBL has a number of different internal error codes that you might see when using LightBurn. These are the most common:

#### BUSY

If you are getting the 'Busy' bar in LightBurn, but the machine does not move, make sure you are actually connected to the controller. You may need to select a communication port (see [connecting to the laser](#)) and if you can't choose a port, it's possible that you need to install the drivers or software that came with your machine before your computer can talk to it (see [connection issues](#)).

#### MACHINE IS BUSY OR PAUSED

If you are seeing this error, most likely you have not actually connected to the machine yet. Make sure you have installed any drivers required by your hardware, and make sure you have chosen a communication port to connect to. When connected, the console should contain messages sent from the controller. If you are not connected, look in the laser window where the mouse pointer is shown below:

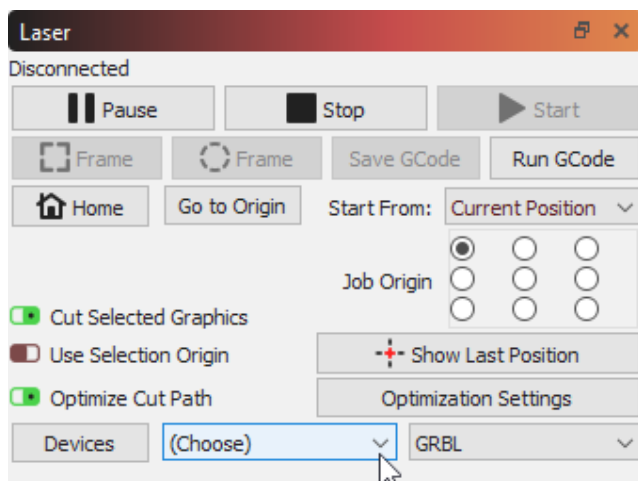

If you click where it says "(Choose)" and the list does not contain any names, or you have tried them all, you might need a driver for your controller to connect to the computer. A common one for Chinese diode engravers is this one:

<https://sparks.gogo.co.nz/ch340.html>

#### ALARM:2

You are trying to send the machine outside of its known working area, and GRBL has prevented this in order to prevent damage to the machine. This can happen for several reasons:

- You are actually trying to run a job that exceeds the size of the machine work area.
- You are trying to run a job in 'Current Position' or 'User Origin' mode and haven't properly set the Job Origin or User Origin settings. Read here: [Coordinates and Job Origin](#)
- You have your machine misconfigured, possibly trying to run a negative workspace machine without a workspace offset: [Common GRBL Setups](#)

#### ERROR:5

This means that LightBurn sent the command to the controller to home it, but the controller does not have homing enabled or configured. The most likely reason for this is that the machine does not have homing switches, and you turned on 'Auto-home on startup' in the device settings.

## Troubleshooting

### 4.7.4 Troubleshooting - Ruida errors

The following are the most common errors encountered with Ruida controllers.

#### NOT ENOUGH EXTEND SPACE

- Your artwork is too close to the side of the machine for the speed you are running it at - the machine does not have enough room off the sides of the design to speed up / slow down. Move the design inward, away from the sides, or go slower.

#### FRAME SLOP OVER

- The design itself is crossing one or more of the machine sides. You can continue, but the controller will not draw the part of the design that is out of bounds.

#### WATER PROTECT

- You have water protection enabled, and the controller is not seeing a signal from the water protection sensor. This

usually means water is not flowing through the tube, but can also mean the sensor is faulty, or the wiring is incorrect.

#### MACHINE PROTECTED

- You have 'door sensor' protection enabled, and the controller is not sensing the door switch is closed. This usually means the machine lid is open, but can also mean the door switch or wiring are faulty.

#### MACHINE IS BUSY OR PAUSED

- This can happen for a number of reasons, all stemming from a lack of communication between the controller and the software. LightBurn will show this error if the laser is currently busy and not accepting commands, *or* in some cases if it wasn't able to communicate with the laser at all. Check that there is not an error displayed on the controller screen, and that LightBurn is actually connected to the controller. You can verify (or reset) the connection by right-clicking the 'Devices' button. You should see 'Found RDC644xG' (or whatever type of controller you have) in the center of the status bar below the main window.



## Troubleshooting

### 4.7.5 Troubleshooting - Output Issues

#### OUTPUT IS MIRRORED OR BACKWARDS

- The '**Device Origin**' setting, found in the menus under Edit => **Device Settings**, controls the orientation of what gets sent to your laser. If you have the origin for the device set incorrectly, your output will be mirrored or upside down when run.
- For DSP controllers (Ruida / Trocen / TopWisdom / etc) the Origin setting for the device should match the corner that your laser homes to when first powered.
- For GCode controllers (GRBL, Smoothieware, etc) the Origin is almost always front-left, but in rare cases may not be.

#### POWER OUTPUT IS NOT THE SAME AS OTHER SOFTWARE (GRBL)

If you have a GRBL device, there are two possible causes for this:

- You're using 'Variable Power' mode (M4), and asking your machine to travel faster than it is able to. This is the most common problem we see, especially when comparing LaserGRBL output with LightBurn. LightBurn uses 'variable power' mode by default (M4), where LaserGRBL uses 'constant power' mode (M3).

With variable mode, when the laser is stopped, the power level is zero. As the laser head accelerates toward the speed you request, the power level is increased as well. In this way, the output burn is much more consistent. However, if you ask the laser to go faster than it actually can, it will never reach the requested speed, and never reach the requested power level either.

The correct solution is to simply use a speed within the allowed speed range of your machine, or, if you want the same behavior as LaserGRBL, click the 'Constant Power' toggle switch in the layer settings of LightBurn:

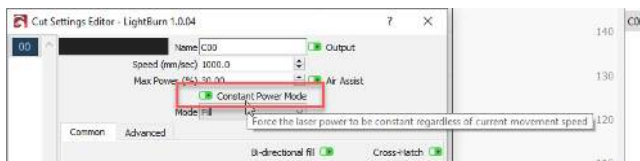

- The 'S-value max' setting in LightBurn could be incorrect - this number tells LightBurn which 'S' value corresponds to maximum output for your machine, normally set in the \$30 firmware setting. Current versions of GRBL default to

1000 for this setting, while older versions use 255. The number itself doesn't matter much, but the controller setting and LightBurn have to agree. If your controller expects "1000" to mean full power, and LightBurn sends "255", you'll get roughly 1/4 the output power you expect.

#### OUTPUT IS SHAKY OR WOBBLY

#### OUTPUT IS SLANTED OR SKEWED

#### EDGES OF ENGRAVINGS ARE BURNT OR TOO DARK

On GCode devices, enable 'Overscanning' in your Fill or Image layer setting. If you already have this enabled, you might need a larger value for the overscan setting, particularly if your acceleration is low.

#### EDGES OF ENGRAVINGS ARE FUZZY OR BLURRY

First, make sure that your X-axis drive belt is tensioned correctly. If it is loose, you'll see blurred or fuzzy sides when engraving, as well as 'bent' or inaccurate shapes when cutting. If the belt is properly tensioned, you likely need to add **scanning offsets**.

#### CORNERS ARE NOT CUTTING OR MARKING

When using a DSP controller, the Min Power setting is also sometimes referred to as 'Corner Power', because it sets the power level of the laser when the machine is moving slowly, like when cutting a sharp corner. If your Min Power value is too low, when the laser slows for corners the power value might fall below the firing threshold of your laser. This will leave gaps in the output at the corners, and at the points where cuts start and stop. Increase the Min Power value.

#### CORNERS ARE BURNT OR TOO DARK

Similar to the above, if the Min Power setting is too high, the power value may not be reduced enough when the laser slows for corners, and can leave burn marks at corner points or the start / stop points of the design. If this is happening, reduce the Min Power setting.

#### LASER IS LOSING POWER / NOT CUTTING AT LOW SPEEDS

On DSP controllers, If you are running a cut at very low speed, set your Min Power and Max Power values to match.

There is a setting in the Machine Settings, called 'Start Speed', that specifies the value where the controller begins ramping the power from Min to Max power. If the laser is moving at this speed or slower, only Min Power is used. This setting is 10mm/sec by default on Ruida controllers, but some machines may have it set as high as 15 to 20 mm/sec, or may have it set lower.

## Troubleshooting

### 4.7.6 Troubleshooting - LightBurn

---

Click the link below that most closely matches your problem:

- [Cut might be out of bounds error?](#)
- [Trouble working with shapes in LightBurn?](#)
- [Trouble with imports or exports?](#)
- [Trouble with cutting / engraving settings?](#)

#### Cut might be out of bounds error

If you get a pop-up that your cut might be out of bounds, there are a few common causes:

- You're using a 'Start From' setting like 'User Origin' or 'Current Position', but don't understand how those work, or haven't chosen an appropriate job origin setting. Try using 'Absolute Coords', and read here to understand how the different modes work: [Coordinates and Job Origin](#)
- Your artwork exceeds one or more of the boundaries of your laser - make sure the art fits, and that if you have Overscanning or Kerf offset enabled, there's room for the overscan / kerf moves
- On GCode devices, it's possible to have a 'workspace offset' programmed into the controller. This could be confusing LightBurn into thinking that the laser position is out of bounds, even though it's not. See [Common Grbl Setups](#)

## Troubleshooting

### 4.7.7 Troubleshooting - LightBurn Editor

---

#### WELD NOT WORKING:

If you are trying to Weld text inside a ring, and the text disappears, use 'Boolean Union' or 'Boolean Subtract' instead. Read the docs and watch the video for Booleans here: [Boolean Tools](#)

#### SHAPES DISAPPEAR WHEN FILLED:

Most likely the shapes are duplicated, sitting right on top of each other. Try Edit > Delete Duplicate Shapes and try again, or manually edit to remove the duplicates. We have a FAQ entry on our forum for this here: <https://forum.lightburnsoftware.com/t/why-do-things-disappear-when-i-fill-them-but-not-when-i-cut-them/1342>

#### OPEN SHAPES SET TO FILL:

If you're getting this error, it means you have shapes that you are trying to fill that are not closed loops. Most likely your shape is a group of disconnected lines, not a single closed loop. Try un-grouping your shapes, then click 'Edit > Auto Join' (Alt+J)

#### NEGATE A VECTOR SHAPE:

If you're trying to negate (invert) a vector shape, you need to put a boundary around it in the same color as the shape itself, or remove a boundary from around it. We have a FAQ entry on our forum that describes this here: <https://forum.lightburnsoftware.com/t/how-do-i-invert-negate-a-vector-engraving/594>

## 4.8 Machine Guides

Machine Guides    Ruida    Thunder Laser

### 4.8.1 Connecting via Ethernet to Ruida Controllers

To avoid using long USB cables, you may want to send jobs to the Ruida controller in your laser via Ethernet networking. This is a guide on how to do so.

#### Attention

This section is new, and is a work in progress. Be sure to let us know [on the forums](#) or via [support](#) if we need to change something. Thank you!

### Networking

Ruida controllers operate over IPv4, or Internet Protocol Version 4, which consists of unique external and unique "local" addresses within a network. Ruida controllers need a "static" IP, or one that's unchanging. More modern networking involves DHCP, where addresses are "loaned" temporarily to devices, like laptops and phones.

In Windows, if you open the command prompt ("cmd" in the start menu or in the Win+R "Run" box) and type "ipconfig", it'll look something like this.

```
Ethernet adapter Ethernet 2:
Connection-specific DNS Suffix . :
Link-local IPv6 Address . . . . . : fe80::8062:587f:6f02:dc31%5
IPv4 Address. . . . . : 192.168.1.233
Subnet Mask . . . . . : 255.255.255.0
Default Gateway . . . . . : 192.168.1.1
```

### CHOOSING AN IP

#### IP Address Example For Home Networks

1. Look for the line in `ipconfig` giving your IP address  
IPv4 . . . 192.168.1.225
2. Remove the last section 192.168.1.225
3. Replace it with a number between 230 and 250 192.168.1.  
**235**

This will probably be safe to use on a home network, but it isn't guaranteed. See links to the left for help.

Unfortunately, choosing a static IP address can be a little tricky. Home networks are usually small and pretty simple, so the steps in the blue box to the right will *usually* be enough to help you choose an unused IP address. If you run into problems with the first number you try, it may be worth trying one or two others to see if there's a conflict.

In more complex network situations, such as a school or shop network, we recommend working with your IT/

networking team to select an IP address and ensure that you don't cause problems for your network infrastructure.

More in-depth networking information can be found at sources like [Google Support](#), [Simple Wikipedia's explanation](#), or other technical resources like Cisco or Meraki's websites. This is a complex topic with a wide range of possible setups, so we are unable to cover every situation.

### ON CONTROLLER

#### Note

Some Ruida controllers have different menuing and button configurations. This is a guideline, not a hard and fast rule.

On the Ruida controller, use the Z/U or Menu buttons to enter the menu, navigate to "IP config+", and press enter to access that menu setting. On the right side of the screen, the IP address field and gateway will be visible. Use the left/right arrows to move through the octets (sections), and the up/down arrows to change the value. Press and hold the up/down arrows to quickly change the value.

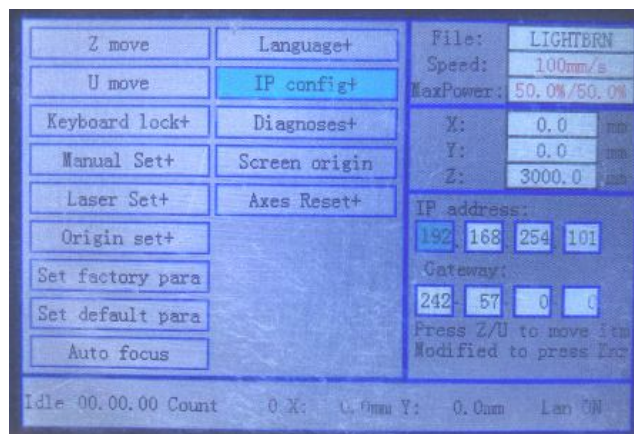

When done, press the "Enter" button.

### In LightBurn

Ruida controllers accessed over a network are their own type of connection for a device, so in the "Devices" menu, click "Create Manually".

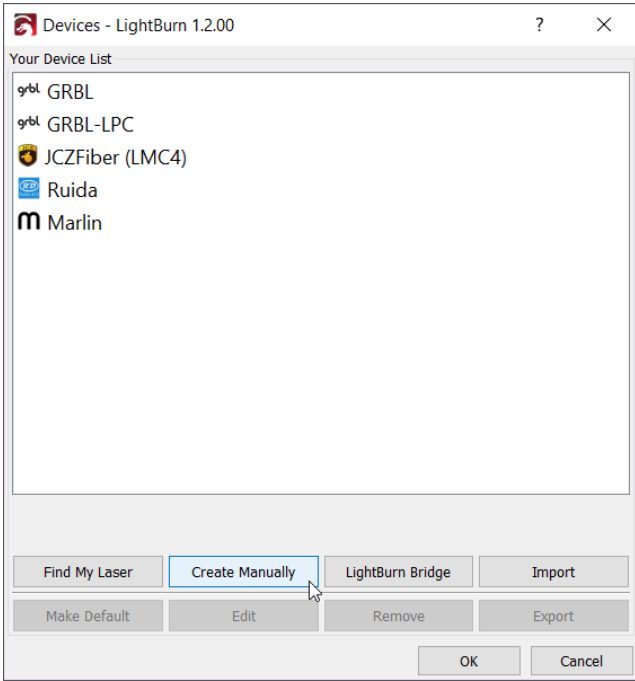

Select the Ruida controller from the list of compatible controllers.

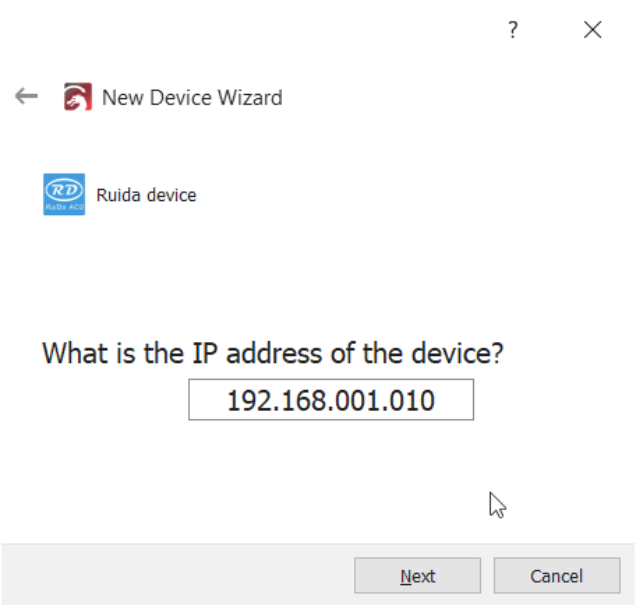

**Note**

Steps below this point are likely to mirror the setup of any prior USB connections set up for the same hardware.

Enter the size of your laser's bed and name the device as it'll show up in your menus.

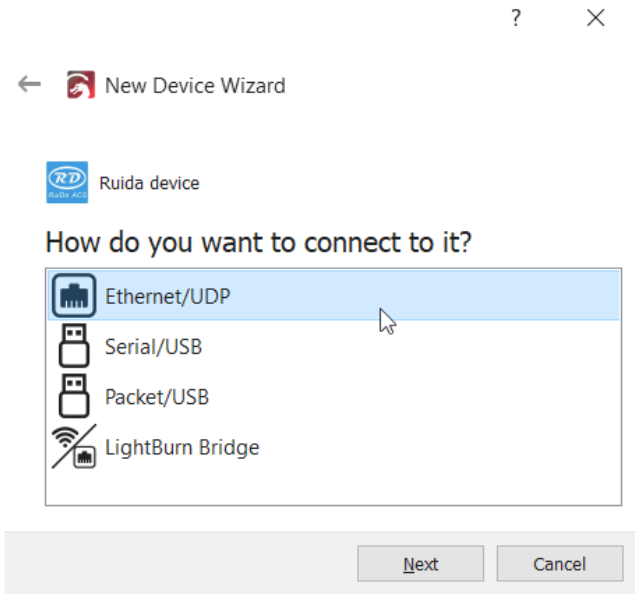

Select "Ethernet/UDP" as the communication method.

**Warning**

In the event this communication method proves unreliable, you may want to consider using a **LightBurn Bridge**, especially if you're using macOS. Bridge provides a much more stable network connection than the Ruida controller's UDP connection.

Enter the IP that was assigned or arrived at for use given the information **above**.

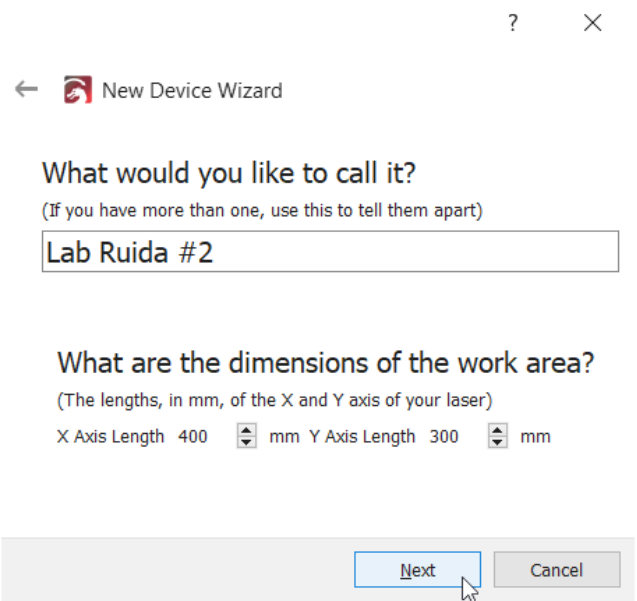

Enter the origin (0,0) position of your machine.

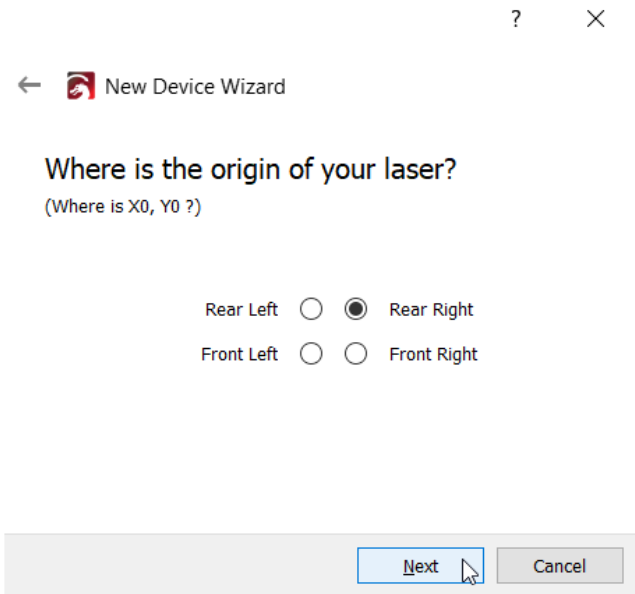

And you're ready to go, assuming all is good!

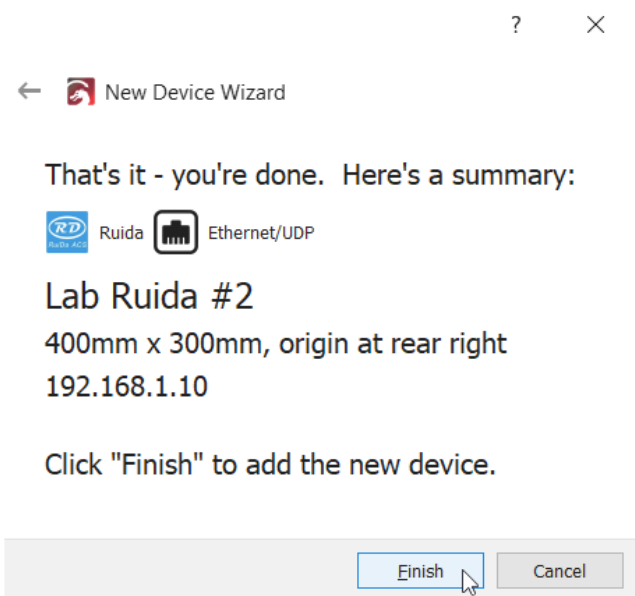

### Verifying

In LightBurn, the status bar on the bottom of the main window will show connection status to the device. In the event LightBurn cannot find your laser, it's likely to show like below.

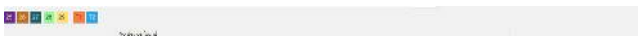

In the event your networking is spotty, you can right-click the "Devices" button to re-connect to any laser; not just your Ruida controller.

### Source

This guide was originally made for our Forums on October 20th, 2019. You can find the original guide [here](#).

Machine Guides Trocen

### 4.8.2 Connecting via Ethernet to Trocen Controllers

To avoid using long USB cables, you may want to send jobs to the Trocen controller in your laser via Ethernet networking. This is a guide on how to do so.

**Attention**

This section is new, and is a work in progress. Be sure to let us know [on the forums](#) or via [support](#) if we need to change something. Thank you!

#### Networking

Trocen controllers operate over IPv4, or Internet Protocol Version 4, which consists of unique external and unique "local" addresses within a network. Trocen controllers need a "static" IP, or one that's unchanging. More modern networking involves DHCP, where addresses are "loaned" temporarily to devices, like laptops and phones.

In Windows, if you open the command prompt ("cmd" in the start menu or in the Win+R "Run" box) and type "ipconfig", it'll look something like this.

```
Ethernet adapter Ethernet 2:
Connection-specific DNS Suffix . :
Link-local IPv6 Address . . . . . : fe80::8062:587f:6f02:dc31%5
IPv4 Address. . . . . : 192.168.1.233
Subnet Mask . . . . . : 255.255.255.0
Default Gateway . . . . . : 192.168.1.1
```

#### CHOOSING AN IP

**IP Address Example For Home Networks**

1. Look for the line in `ipconfig` giving your IP address  
IPv4 . . . . . 192.168.1.225
2. Remove the last section 192.168.1.225
3. Replace it with a number between 230 and 250 192.168.1.  
**235**

This will probably be safe to use on a home network, but it isn't guaranteed. See links to the left for help.

Unfortunately, choosing a static IP address can be a little tricky. Home networks are usually small and pretty simple, so the steps in the blue box to the right will *usually* be enough to help you choose an unused IP address. If you run into problems with the first number you try, it may be worth trying one or two others to see if there's a conflict.

In more complex network situations, such as a school or shop network, we recommend working with your IT/networking team to select an IP address and ensure that you don't cause problems for your network infrastructure.

More in-depth networking information can be found at sources like [Google Support](#), [Simple Wikipedia's explanation](#), or other technical resources like Cisco or Meraki's websites. This is a complex topic with a wide range of possible setups, so we are unable to cover every situation.

#### ON CONTROLLER

**Note**

Some Trocen controllers have different menuing and button configurations. This is a guideline, not a hard and fast rule.

On the Trocen controller, use the Menu button to enter the menu, navigate to "Network Settings", and press enter / the mouse pointer button to access that menu setting.

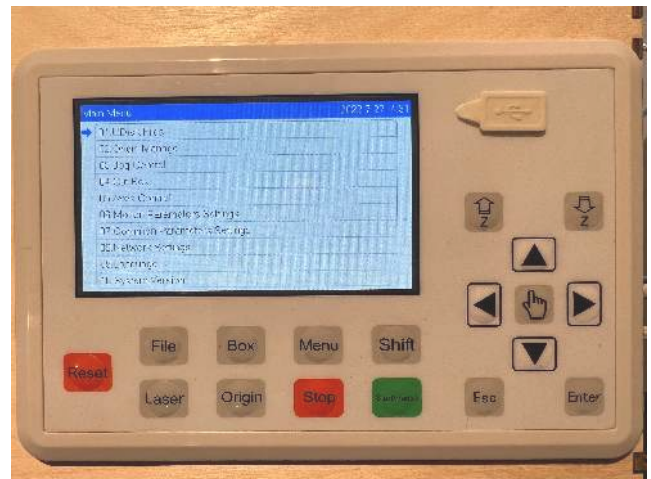

Each octet of the IP will be editable, enter the menu, exit that subsection, and continue to enter your IP for the laser.

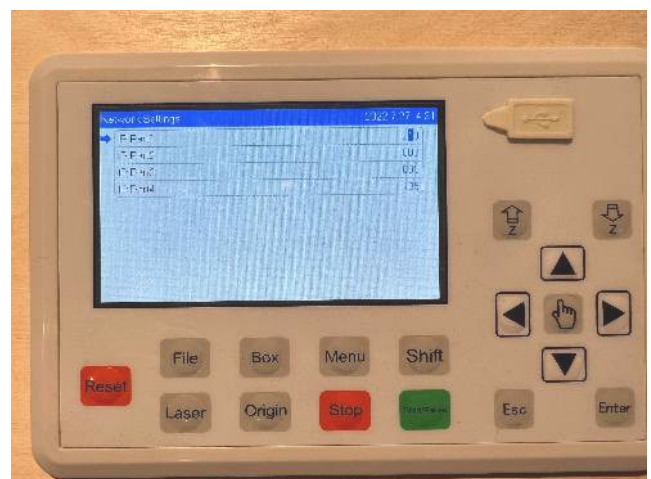

When done, exit the menu.

### In LightBurn

Trocen controllers accessed over a network are their own type of connection for a device, so in the "Devices" menu, click "Create Manually".

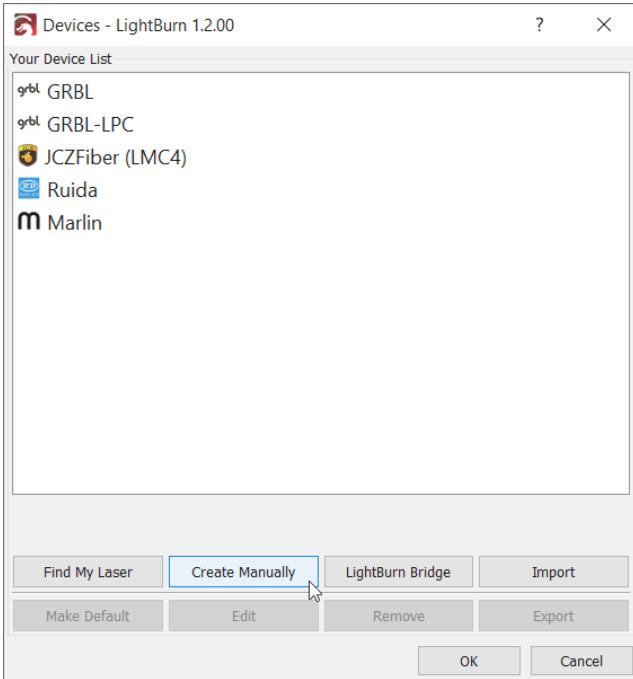

Select the Trocen controller from the list of compatible controllers.

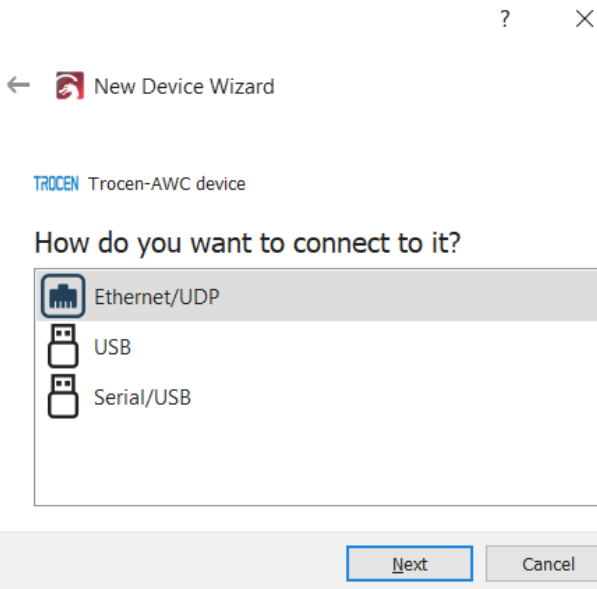

Select "Ethernet/UDP" as the communication method.

### Warning

In the event this communication method proves unreliable, you may want to consider using a **LightBurn Bridge**, especially if you're using macOS. Bridge provides a much more stable network connection than the Ruida controller's UDP connection.

Enter the IP that was assigned or arrived at for use given the information **above**.

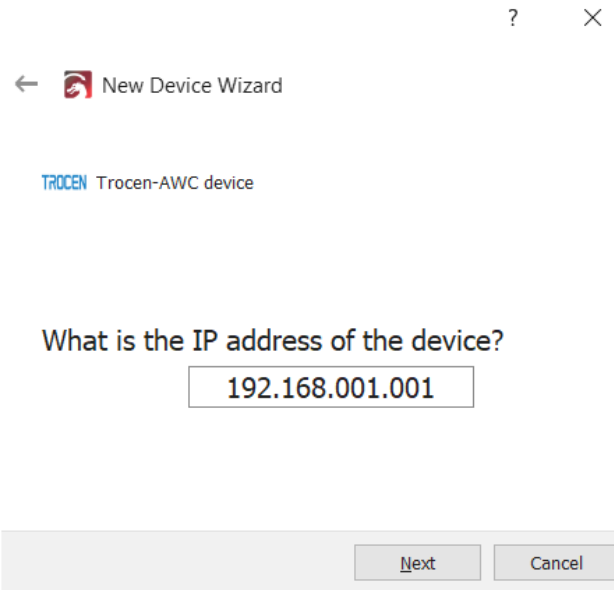

### Note

Steps below this point are likely to mirror the setup of any prior USB connections set up for the same hardware.

Enter the size of your laser's bed and name the device as it'll show up in your menus.



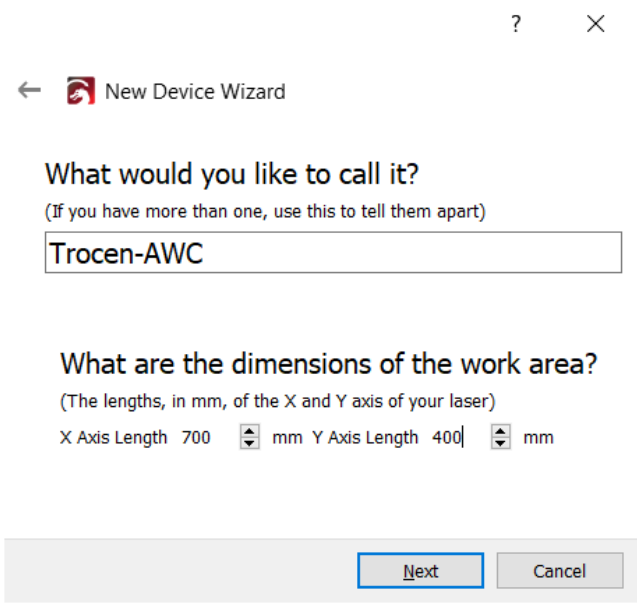

Enter the origin (0,0) position of your machine.

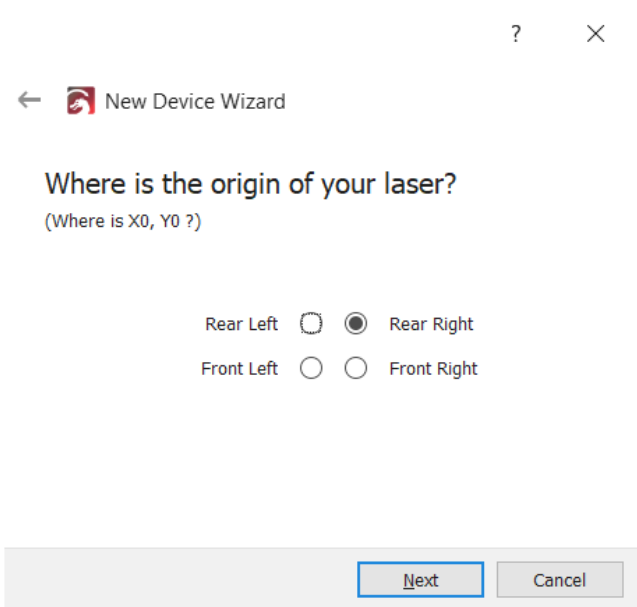

And you're ready to go, assuming all is good!

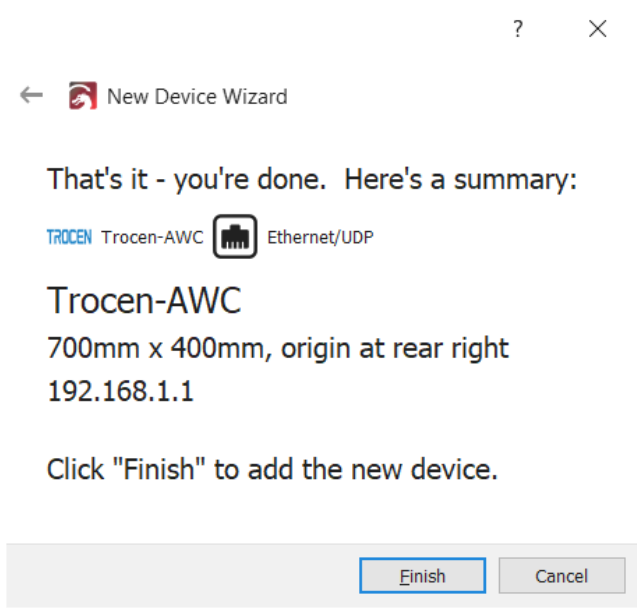

**Verifying**

In LightBurn, the status bar on the bottom of the main window will show connection status to the device. In the event LightBurn cannot find your laser, it's likely to show like below.

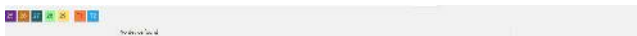

In the event your networking is spotty, you can right-click the "Devices" button to re-connect to any laser; not just your Trocen controller.

**Source**

This guide was originally made for our Forums on October 20th, 2019. You can find the original guide [here](#).

## 4.8.3 Adding Limit Switches to Sculpfun S9 Diode Lasers

This guide shows the steps to install limit switches on a Sculpfun S9 diode laser using off the shelf components, and some laser cut parts. This enables reliable, consistent alignment within the engraving or cutting area with less work for the operator. This guide will be applicable to other diode lasers (such as an AtomStack), especially those using a MKS DLC 2.0 control board and similar.

This enables the use of LightBurn features on these machines, including:

- [Print and Cut](#)
- [Center Finder Tool](#)
- [Using A Camera](#)

### **Danger**

This guide assumes electrical and mechanical know-how to safely install and enable these features. Please take care to avoid damaging the machine and those around it, including you!

***Proceed with caution!***

### What You'll Need

Some of the materials you'd need (but not necessarily all) include:

- A compatible diode laser
- [3 Pin Limit Switches](#)
- [servo extension cables](#)
- If your cables don't comfortably reach, you may need to purchase or assemble an extension cable yourself.
- Brackets to hold limit switches to your frame (one per limit switch on your frame)
- [LBRN File](#) for Laser Cutting (cut from [3mm wood](#) or acrylic)
- [STL File](#) for 3D Printing
- [M3 2020 T-nuts](#)
- [M3 Screws](#)
- M3 Hex Driver
- [2020 Extrusion Cover](#)
- Scissors (to cut said extrusion cover)
- Zip Ties (to fasten the limit switch cables)

If you'd like to create custom cables rather than use a servo extension cable, here are the ones we used.

- [Engineer PA-09 Crimper](#)
- [Wire](#)
- [JST Connectors](#)

### LIMIT SWITCHES

Limit switches are small, electro-mechanical devices that when depressed, create a pathway for a signal to pass through. We can use them to tell the laser's controller that we've reached the end of their motion.

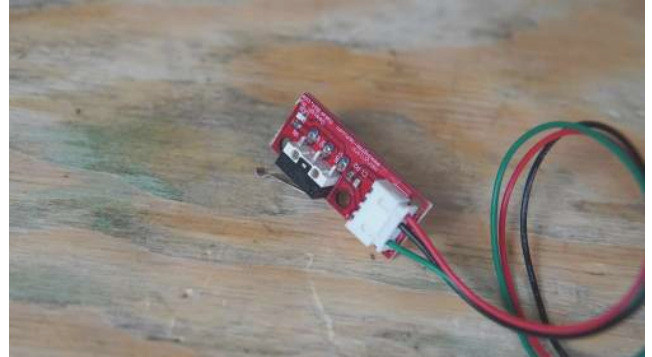

In this guide, we'll be using a 3 wire style limit switch, mounted to a printed circuit board to make installing it on your machine easier.

### LIMIT SWITCH CABLING

These cables are responsible for passing the signal back to your laser, and through checks are required to connect them correctly. If the cable is too short, it can damage the connector, damage your diode laser, or other components.

### Before Disassembly

If you intend to use the [laser cut brackets](#) for the limit switches, you'll want to cut those before disassembling your laser for installation.

### CUTTING OUT BRACKETS

Same as with standard use of your laser, you'll want to focus the head relative to the cutting material, in our case, some thin 3mm wood.

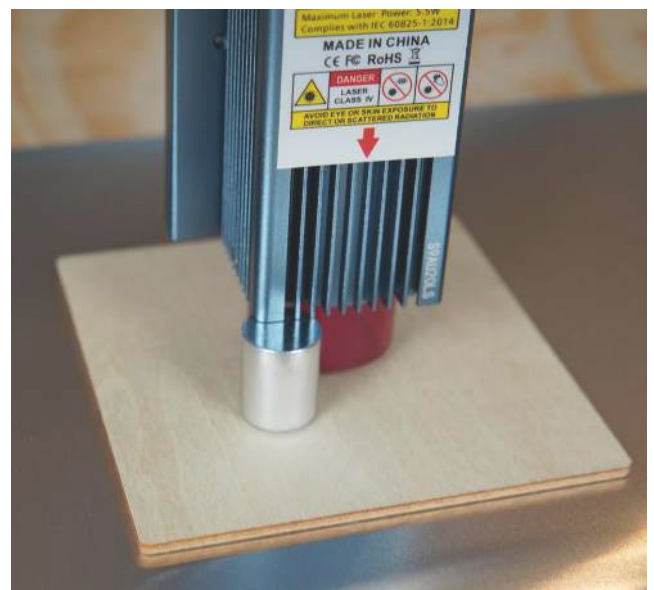

**DOCUMENT SETUP**

Use the LightBurn preview window to ensure that your document as set up looks good. The default settings for the S9 should be adequate. We used:

250mm/m  
 100% Power Max (%)  
 Pass Count: 2

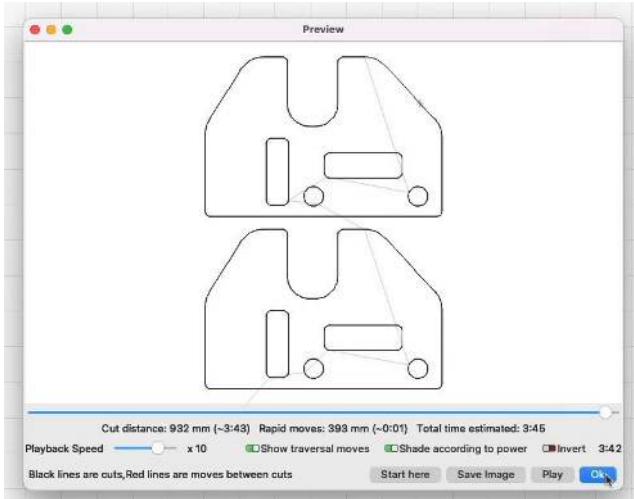

You may want to use the "Square Frame" command within LightBurn to ensure the material you're engraving has the sufficient area to cut out the brackets.

**Mechanical Installation**

To install the limit switches, you'll need to insert an M3 2020 t-nut into the frame sideways, and then rotate it 90° in the frame slot to align correctly for retention. You may need other tools to insert & rotate them appropriately; we found that a small flat-bladed screwdriver may be helpful.



When mounting the limit switch, place the cut or printed spacer underneath the limit switch board, and oriented it such that the "arm" of the limit switch faces the head of the laser.

Here we use a M3 x 8mm screw to fasten the board to the frame.

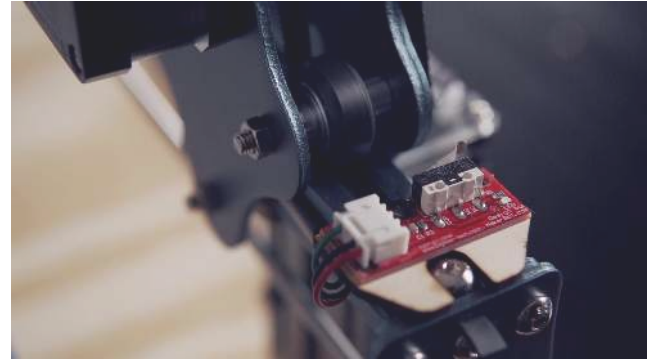

This process should be repeated such that a limit switch is positioned for both the X and Y axes of the machine.



**Wiring**

Our limit switches are labeled as having three pins for use:

- G - Ground
- V - Voltage
- S - Signal

This labeling also applies to the printed circuit board that has the control electronics of the laser. Be sure to match each axis' limit switch to the correct connector and direction, for X or Y axis as is correct.

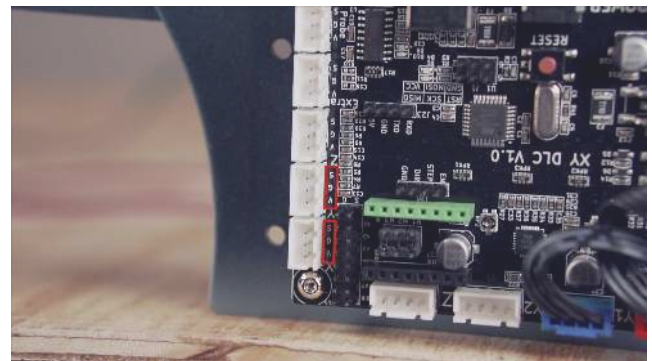

**Notes on Extensions**

The cables we're using, while they technically fit, aren't what's intended on these connectors. We suggest you use a crimper and make a custom cable, but we understand this isn't possible for everyone and opted to include this as a more accessible option.



The preferred way would have the user crimp JST connections on a single length of cable per axis and make it exactly to length, but we recognize this isn't always an option.

### **Danger**

Please be aware that use of "PWM" style connectors in a JST housing permits the inversion of the connection, potentially damaging your laser. Ensure the pins are connected with the correct labels (i.e. ground to ground, signal to signal, etc.) before turning on your laser on.

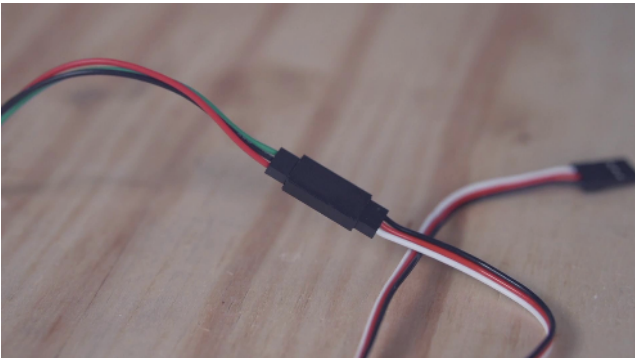

When continuing to hook up the wiring, you'll likely want to route the extensions or connections through the pre-existing hole in the housing, or through the vent holes on the side. This ensures you can re-close the housing and protect your electronics.



Next you'll need to test the machine while opened up. This allows you to resolve those issues you might encounter more easily. Carefully reconnect power and USB to the device, and turn it back on.

The diode laser won't immediately understand how to use the limit switches, and as such, we'll need to do software configuration within LightBurn.

### **Software**

The first major check is to ensure that upon re-powering the device, LightBurn can still see your laser; confirm this through the Console dock. If so, you'll need to use the following codes to enable limit switch homing.

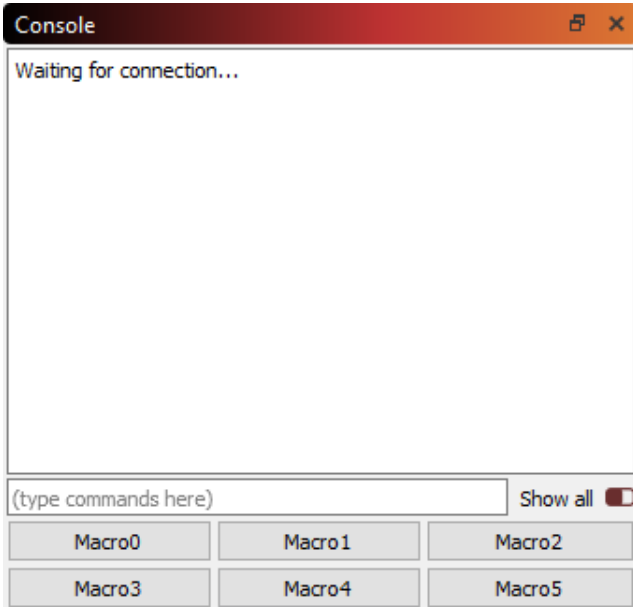

```
$Z2=1
```

**Danger**

Be ready to power off the machine in the event it does something unintended and dangerous.

This GRBL command enables limit-switch based homing. To test your homing behavior, click the "Home" button in LightBurn in the "Laser" window.

If your device attempts to home in the wrong direction, you may need to change the "homing location" via more GRBL commands.

For ours, we needed to do `$Z3=3` to chose the near, left side as our 'home' location. If your device has the limit switches in another location, you'll want to reference [this guide](#) as to what the different values mean with respect to limit switch "bitmasks".

**HOMING SPEED**

By default, our device was rather slow during the homing process, and we changed the following to allow it to home more quickly.

```
$Z5=8000 (homing speed)
$Z4=100 (re-seek speed)
```

The final configuration information needed are for the workspace offset, which we can find by looking in the "Move" window when clicking "Get Position".

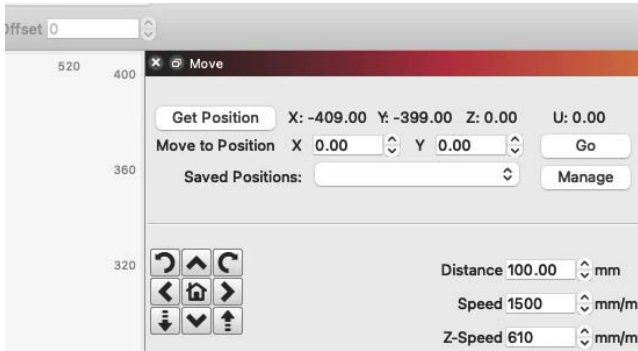

Taking these values, go back to the "Console" tab and enter the following GCode command:

```
G10 L2 P1 X-409 Y-399
```

These values directly use the data observed just prior, with the L2 P1 portion indicating to the device the specific offset mode (current workspace offsets to the specified values) and P1 to the "tool number" (value of 1, the first and only present on this machine).

We'll also need to tell the machine's status reporting to be relative to the workspace origin, and we can do that with:

```
$I10=0
```

**STOCK FIRMWARE WARNING**

Many devices don't actually have GRBL firmware that by default stores these values in the memory of the laser's controller. As such, rebooting would wipe these values out, reverting the work you've done.

The correct fix would be to re-flash the firmware, of which we'll have a guide for soon. However, in the interim you can use the "Macros" button under the "Console" window.

By right-clicking the button, we can re-name it, and combine all of our commands together for use, which might look something like this:

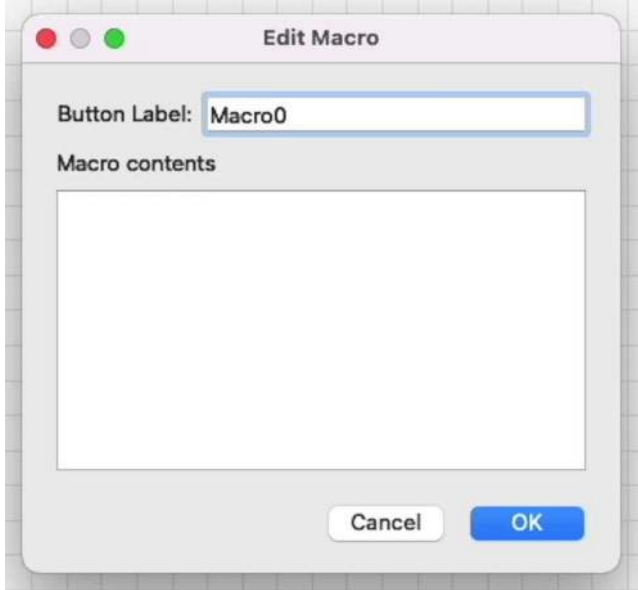

If you'd like to copy this behavior and simply use it as-is, still verify your `G10` command has the correct offsets.

```
$Z2=1
$Z3=3
$Z5=8000
$Z4=100
G10 L2 P1 X-409 Y-399
$10=0
```

### Reassembly

Once we've confirmed that this configuration works correctly, we can begin to reassemble our housing and more permanently install the wires for the limit switches. Turn the machine off to do so, to avoid any errant connections of the case to the electronics resulting in a short.



You can use 2020 extrusion covers cut to size to protect and hide the wires inside the grooves of the extrusion frame, and zip-tie the limit switch cable for the gantry to the pre-existing cable to the diode head itself.

## Machine Guides    Sculpfun S9

## 4.8.4 Flashing Guide

If your Sculpfun S9 (or similar laser) doesn't have the ability to permanently save changes made to the firmware, you may need to re-flash the microcontroller inside of it. This lets the brain running the diode use newer features of GRBL (the software controlling your laser inside it's electronics) effectively, and helps you avoid the possibility of forgetting to click the homing button.

## Prerequisites

While this guide requires no additional physical components, several downloads are needed.

- [Arduino IDE](#)
- [GRBL \(with tweaks to disable Z axis\)](#)

## Info

This guide was written for older versions of the Arduino IDE released before 2.0. Major changes were made when that version was released, and as such, this guide may not work with them. Please revert to use these steps, or find a newer guide to update your laser. Thank you!

## Warning

To successfully flash your laser, high attention to detail is needed. Flashing your firmware incorrectly can damage your machine. Read the whole guide, start to finish, before trying to flash your machine.

## Prep

Plug in your laser's power and USB, connect it to your computer, and open LightBurn.

In LightBurn, use the macro created in the [Limit Switch Guide](#) to apply the needed limit switch firmware changes, and afterwards use the Edit -> Machine Settings dialog. In this window, you'll want to click "Save to file". This allows you to save a backup of the laser's configuration that's know to work before we flash firmware and reset all of those settings.

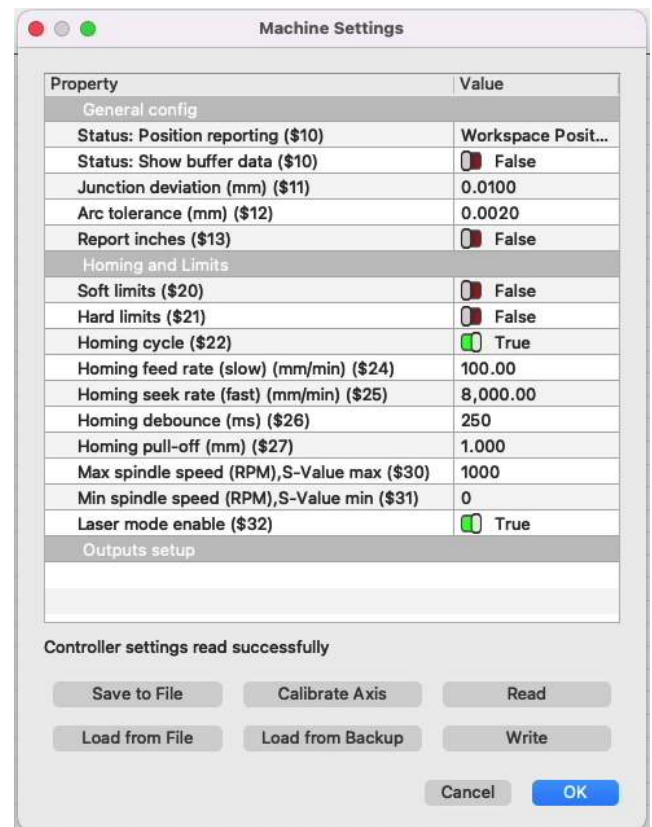

## BACKUP VIA CONSOLE

Using the Console, you can enter "\$\$" to get the GRBL values of the machine to supplement those from the Machine Settings window. This gives you a further verification step to make sure the laser's behavior is as intended after flashing. Copy those to a text editor like Notepad or TextEdit and save for safekeeping.

## Attention

At this point, please close LightBurn. Not doing so will cause flashing errors later in this process.

## Arduino IDE

To flash a newer version of GRBL to your laser, you'll need to download Arduino IDE. As a toolkit to enable microcontroller development in a friendly bundle, it allows you to make any changes we might need to make, connect to the laser, and send the new version of GRBL to your device.

You'll need to install Arduino IDE through the appropriate installer for your system, but the specifics will vary computer to computer.

## GRBL

To actually have something to flash to the laser, you'll need GRBL. An off-the-shelf version of GRBL however, assumes

we have three axes, not two. As a result, when it goes to home the "Z" axis, it never proceeds to the next step as it physically cannot trigger a limit switch that doesn't exist.

To make this step easier, we already made the necessary modifications to the last current (1.1h) GRBL version for you, disabling the third axis. Download the [file linked](#) and extract it.

### Setting Up Arduino IDE

In Arduino IDE, we'll need to open the Sketch Menu, click "Include Library", and then "Add .ZIP Library". This allows us to tell The Arduino IDE that the code you've downloaded is something you need it to use.

**Warning**

Make sure that "Makefile", "COPYING" and "README.md" are visible in the folder you select; the folder inside of that one labeled grbl is *not* the correct folder for Arduino IDE to recognize it.

In other words, select the grbl folder in the root of the ZIP you extracted.

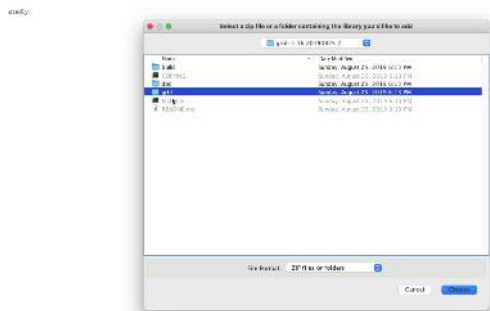

You'll then need to go back to the menu by going to Sketch, Include Library and ensure that "grbl" is listed under "Contributed Libraries".

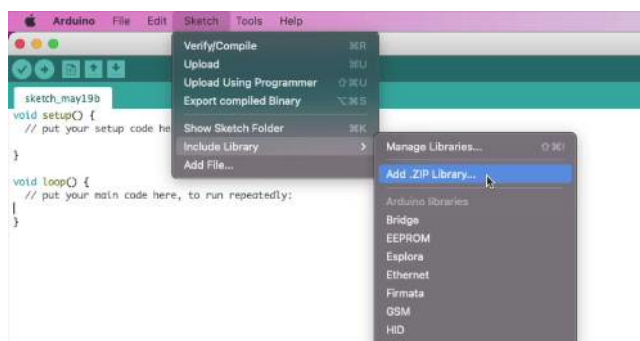

To get ready to flash your board, open the "File" menu, Examples, "grbl" and "grblUpload". It will open a new window containing the sketch mostly ready to go. You'll need to select your board and port still, and tell Arduino how and where to upload the new firmware.

### PORT & BOARD CONFIGURATION

We're working with a board resembling the MKS DLC 2.0, running an Atmel 328p. To the Arduino IDE, this is an Arduino Uno, as that's the chip the Uno is based on. Under Tools, Board, select "Arduino Uno" near the top of the list.

You'll also need to select the correct port to send the firmware on, so open Tools, Port, and take note of the ports listed.

Connect your laser via USB and check the Ports menu again to look for any new devices. Unplug and replug your laser once more to confirm the port the laser is on, and select it.

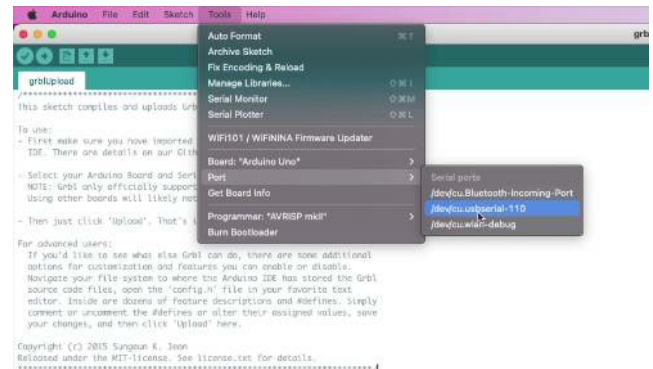

### Flashing

Use the checkmark  at the top left to verify that you've set the project up correctly, and note on the bottom of the screen above the black terminal area says "Done compiling." when you do so. If it does, we're ready to upload!

```
Released under the MIT-license
*****

#include <grbl.h>

// Do not alter this file!
```

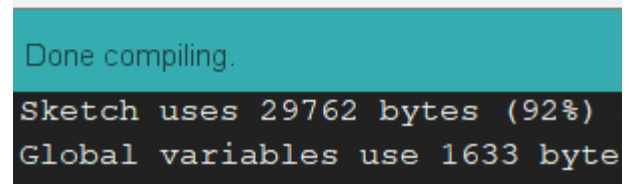

Click the arrow button  to the right of the checkmark, and it'll begin to flash to your laser! When "Done uploading." is shown, you can continue!



**Note**

If there's an error shown that it can't access the port in some way, make sure that you closed LightBurn. Only one device can "have control" of certain peripherals, and Arduino IDE needs full control of that device for a moment to send the new firmware.

**Restoring Settings**

In LightBurn, open the Machine Settings menu again, and click "Load from file", selecting the "lbset" or "LightBurn Settings" file we'd made at the start of the guide. At this point, click "Write" to apply these settings to our machine's firmware. This transfers the configuration back to the machine, and writes them to EEPROM, or programmable memory. This means our homing behavior will be consistent through machine reboots.

When this has finished, the window will show "controller settings written successfully".

**Verifying**

In the console, enter

```
$$
```

Once more and verify that the settings match that of the macro made originally, and/or the backup file we made when **backing up via Console**.

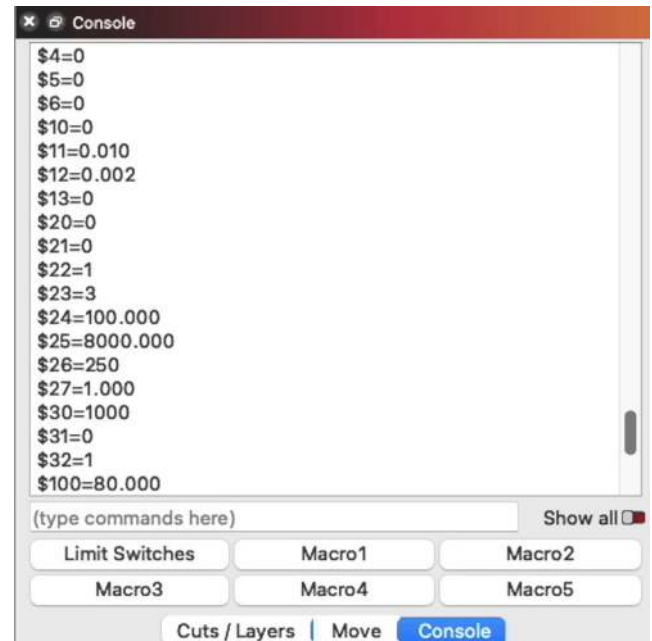
**Finished!**

If these settings hold, you'll be able to click the "Home" button in LightBurn and have it home automatically, without any additional use of macros.

## 5. Galvo Docs

---

**Galvo LightBurn 1.2**

### 5.1 LightBurn & Galvos

---

If this is your first time using LightBurn, you'll definitely want to take a look at the [user interface](#) guide first and maybe some [hotkeys](#) first before diving in.

#### Attention

This section is new, and is a work in progress. Be sure to let us know [on the forums](#) or via [support](#) if we need to change something. Thank you!

#### 5.1.1 Getting Started

---

- [Glossary](#)
- [Galvo Installation](#) - This is Windows-only and covers the driver changes needed to control your galvo laser. If you're not using Windows, you can skip ahead to [Galvo Setup](#)
- [Galvo Setup](#) (importing configs, getting them from your manufacturer)
- [Lens Correction \(Bulge, Skew, Trapezoid, Stretch\)](#)
- [Framing Mode](#)
- [Focusing](#)
- [Cylinder Correction](#)
- [Galvo Settings](#)
- [Sub-Layers](#)
- [Rotaries](#)

#### 5.1.2 Intermediate Mechanics

---

- [Changing A Lens](#)
- [3D Sliced Engravings](#)
- [Anatomy of a Galvo](#)

#### 5.1.3 Involved Topics & Diagnostics

---

- [Laser Timings](#) (for dealing with the physical limitations of galvo heads)
- [IO Port Control](#) (external event triggering)

#### 5.1.4 Galvo Crash Course from Laser Everything

---

Our friends at Laser Everything have put together some fantastic videos on using LightBurn for Galvo. We encourage you to check out their [YouTube Channel](#) for additional resources.

#### 5.1.5 Frequently Asked Questions

---

##### Can I import an EZCAD project/parameter/file?

LightBurn as of 1.2.00, does not have the ability to import or open EZCAD project files or parameters. Due to the file format not being documented, and the sheer volume of effort to produce a useful, cohesive importer, it simply isn't possible at the moment. The exception to this is lens correction files, as outlined [here](#).

##### LightBurn on Linux doesn't recognize fiber laser plugged in with USB

This is an issue we haven't generally encountered in our own testing in Ubuntu and Fedora, the two distros we support. The laser is treated as a libusb device and *should* just work. However, this is occasionally an issue with USB permissions. Please try the following, as discussed on our [forum](#).

- Unplug your laser from the computer.
- Run `sudo gedit /etc/udev/rules.d/usb.rules` (you can use any text editor you prefer) and enter the following contents:
 

```
SUBSYSTEM=="usb", MODE="0666"
```
- Save the file and close.
- Run: `sudo udevadm control --reload-rules`
- Now plug your galvo USB connection back into the machine.
- Run LightBurn without sudo and you should be able to automatically find and connect to the device.

##### Where are the hatch settings?

Hatch in EZCAD is the equivalent of "Fill" in LightBurn; looking at the different modes for [Cut Settings Editor](#) is highly suggested to make the best use of LightBurn with your galvo. We also have a page [comparing EZCAD hatch](#)

[settings with LightBurn fill settings](#) to help you match the settings you're used to.

**It won't connect to LightBurn after moving USB ports!**

Some lasers require you to fully reboot the device after moving USB ports. The suggested workflow is:

1. Turn the laser fully off.
2. Move the USB cable to the correct port.
3. Turn the laser back on.

**Can I convert from EZCAD2 to LightBurn files?**

As of 1.2.01, you cannot import an Ezcad2 project file to LightBurn directly. If the grid in Ezcad is turned off temporarily, LightBurn can trace screenshots of Ezcad easily to import placement in many situations.

**My galvo is trying to engrave my rotary, what's wrong?**

LightBurn allows you to offset your rotary's "center" when engraving with a rotary, to compensate for the rotary being aligned physically to the frame on a different pattern than your lens. Please see the section on [output centers](#) for more information.

## 5.2 Glossary (Galvo)

### Attention

This section is new, and is a work in progress. Be sure to let us know [on the forums](#) or via [support](#) if we need to change something. Thank you!

### 5.2.1 Galvo

A type of laser apparatus that uses a series of actuated mirrors to reflect the beam of a laser source around at high speeds. This contrasts to "gantry" style lasers, that move a series of mirrors along the gantry itself with a "lens" at the end to focus it, or diode lasers that move the laser source itself, (usually using a gantry).

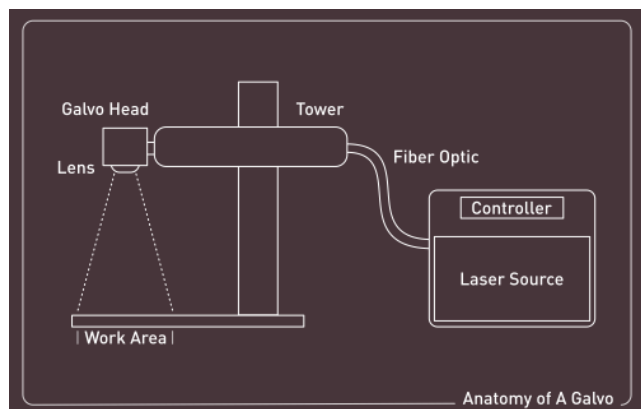

### 5.2.2 Source

This is the portion of a galvo laser responsible for producing the beam itself used for operation. While not a laser tube inherently, laser sources are similar in purpose to the tubes found in CO<sub>2</sub> gantry lasers.

### 5.2.3 MOPA

Master Oscillator Power Amplifier lasers are a specific class of fiber laser sources that enable pulse duration to be varied (not just pulse energy and frequency as in other sources). This variability enables use cases such as durable colored marking of stainless steels and titanium by pulsing the beam in such a way it anneals the metal.

### 5.2.4 Tower

This is the portion of galvo lasers responsible for moving the galvo head up and down, vertically. The tower connects the head to the fiber cable (that carries the beam from the source), and any other apparatus that need to move with the lens to focus and effectively work on the job.

### 5.2.5 Framing

Framing allows you to accurately position work. It's an operation that outlines the job in real life on the object/material, but using a lower power, so it doesn't cut/engrave it. It usually requires you to be accurately focused.



### 5.2.6 Frame/Base

This is the portion of a galvo laser that holds up the tower and ensures it's rigid and won't tip over. It usually has a work table larger than the tower above it for stability.

### 5.2.7 Cleanup Pass

A final pass, usually at a tighter line width, higher frequency, and a lower power. Done to clean up soot and debris from more ablative processing.

### 5.2.8 Focal Point (Waist)

The thinnest part of the (focused) beam, the point at which it is the most in focus. See the [Focusing](#) page for more info.

### 5.2.9 Focal Length

The distance from the optical centre of the lens to the focal point. See the [Focusing](#) page for more info.

### 5.2.10 Depth of Field (Focal Range)

The useable range of the (focused) beam. It appears either side of the focal point, and varies based on various factors including; the focal length of the lense, the material being

cut, the power of the laser source, etc. See the [Focusing](#) page for more info.

### 5.2.11 Field Size (Build Volume, Window Size)

These fields describe the maximum area that the lens installed in the galvo can physically cover when focused. See the [Focusing](#) page for more info.

### 5.2.12 Wobble

Wobble refers to the ability of the beam to rotate about a particular area, imparting more heat to the workpiece and allowing for more material removal.

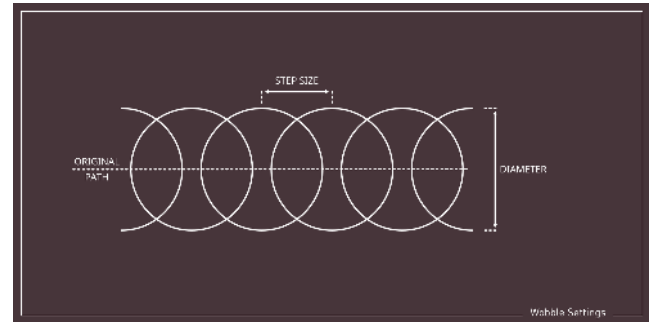

This feature can be enabled in the [Cut Settings Editor](#) on galvo devices.

## Galvo LightBurn 1.2

## 5.3 Installing Drivers (Windows only)

**Attention**

This section is new, and is a work in progress. Be sure to let us know [on the forums](#) or via [support](#) if we need to change something. Thank you!

If you haven't already installed LightBurn, please start by [installing it](#) on your computer.

## 5.3.1 Installing The Driver

When installing LightBurn, the last screen of the installer has a set of tickboxes to install additional drivers needed for certain types of machines. We'll need to add the "EzCad2 driver" used by galvos before LightBurn can see the galvo you're trying to set up.

If during initial installation you didn't tick this box, you can simply run the installer again, and select this box to ensure the driver is installed for use. Windows will prompt you for permissions escalation to install it, and quickly replace the driver provided by default with one LightBurn can use to communicate with your galvo-based laser.

Alternately, the installer for the driver is in the LightBurn files at "C:\Program Files\LightBurn\EzCad2Driver\" and can be run again via the "dpinst-x64.exe" file directly.

**Info**

This installed driver may not work correctly with Windows 7. Please see the [Zadig method](#) below.

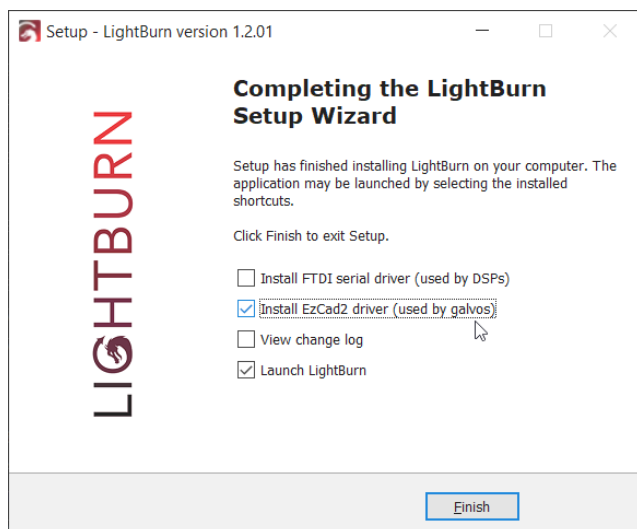

## 5.3.2 Restoring the Driver

In the event you want to use EZCAD it's a simple task to revert to the original driver.

Open your Windows Device Manager - You can do this by clicking 'Start' and typing 'Device' and letting it auto-complete.

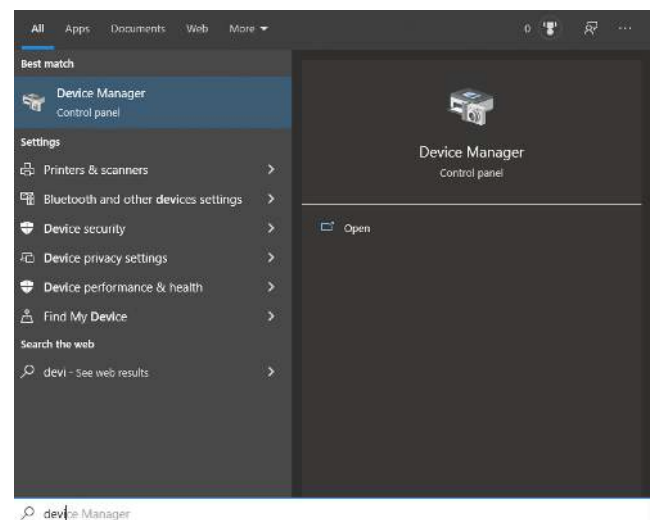

Next, find the USBLMC device in the list - it should be near the bottom, under 'Universal Serial Bus devices', shown below:

### 5.3.3 Zadig-based Driver Swap

In the event the driver swap (performed by running the installer) isn't working, it may be suggested to try and use Zadig (a driver tool) to replace the manufacturer's with a generic driver so LightBurn can communicate with it. Below are those steps.

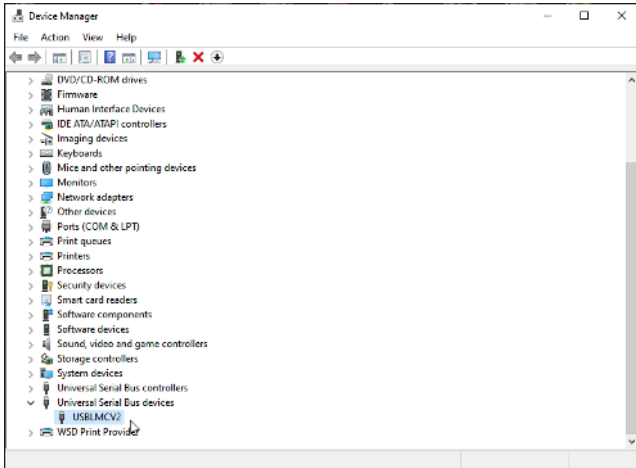

Right-Click the device and choose 'Uninstall Device' from the pop-up menu.

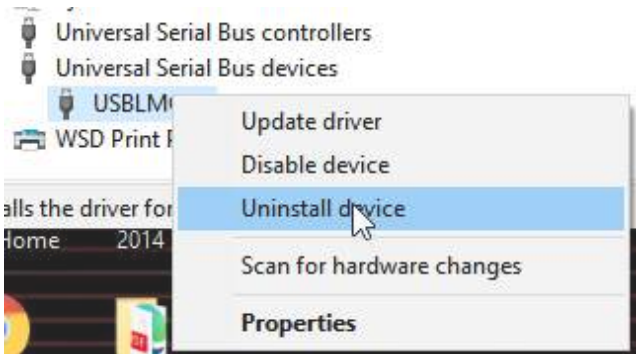

In the next window, check the box to delete the driver. (this doesn't actually delete anything from your system, it just completely dis-associates the driver from this device)

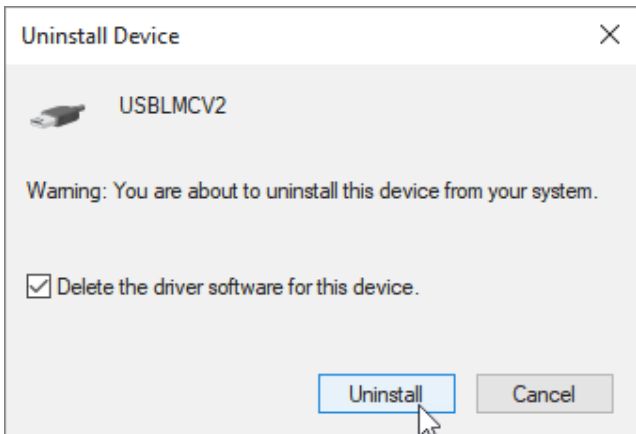

Click the 'Uninstall' button. The process should finish quickly.

If you power off the laser and power it back on, Windows will reconnect, realize that it already has a driver for this device (the old LMC driver) and it'll appear in the Devices list again, near the top, as a BJJZ device. That's it - You can use EZCAD again.

### Quick Zadig-based Driver Swap

Download Zadig, the driver replacement tool from <https://zadig.akeo.ie/> and run it. (it doesn't require installation)

You'll see a window that looks like this:

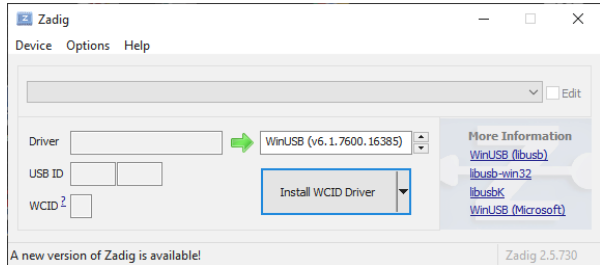

Open the 'Options' menu and enable 'List All Devices'

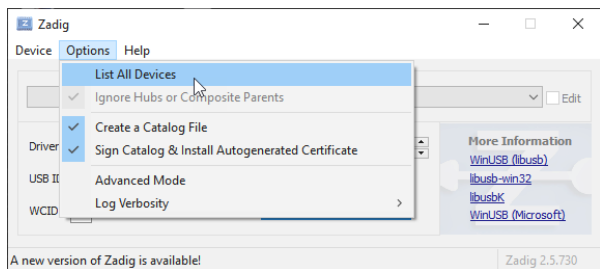

If your EZCAD laser is powered up and connected with the USB cable, you should see USBLMCV2 (or very similar) in the device list, like this:

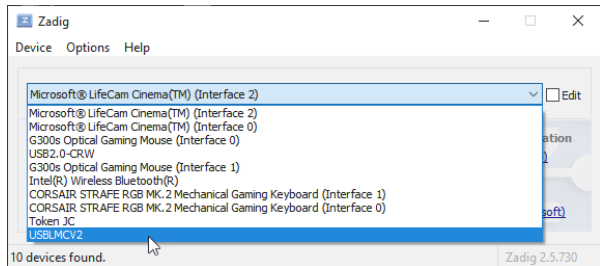

Select that device, and choose 'WinUSB' as the target driver, like this:

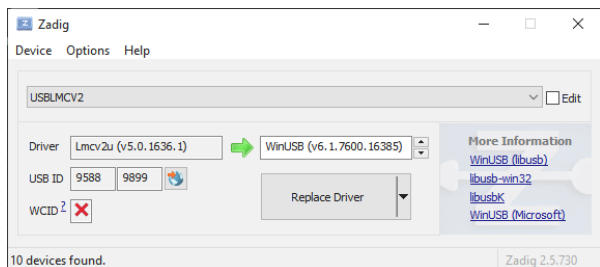

Double check that it says LMCV2U in the 'Driver' box, and that the USB ID under it matches what you see above. If you haven't used the laser with this computer before, the 'Driver' box may be empty instead.

Click 'Replace Driver' and wait for the process to complete. Make sure that you are not running EZCAD when you do this - if anything is actually *using* the hardware, the driver swap will likely not complete, and time-out after five minutes. If

everything goes as expected, it takes about a minute, often less.

You'll see some different messages cycle through while it does the install. When it's done, it might ask you to reboot, but that's rarely required.

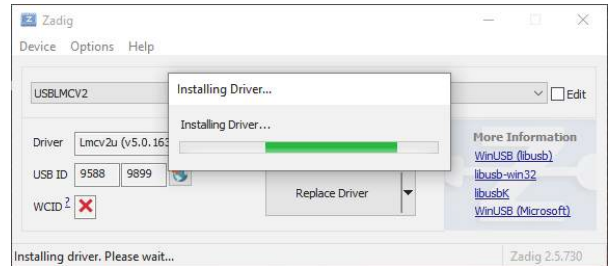

On the rare occasion that Zadig fails, just try it again - it almost always works, and sometimes reports a failed installation erroneously, when it actually succeeded. You *should* see this:

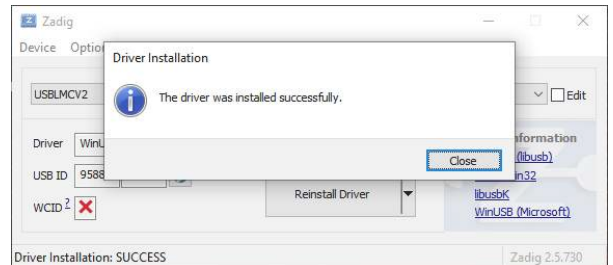



## Galvo LightBurn 1.2

## 5.4 Adding &amp; Setting Up Your Galvo

**Attention**

This section is new, and is a work in progress. Be sure to let us know [on the forums](#) or via [support](#) if we need to change something. Thank you!

To set up and configure your galvo laser, you'll need to create a new device, and import or manually enter settings provided by your laser manufacturer.

It's also a good idea to set up a new device profile for each lens you have for your galvo, because changing lenses will affect many parameters. You can duplicate a device after setting it up by right clicking on it in the 'Devices' window and choosing 'Duplicate'. This is the easiest way to add a new profile while keeping the settings, so you only have to update parameters that change with the lens.

To add a new device LightBurn, click the 'Devices' button. From here you have two options: [the importer](#) or [manual entry](#).

## 5.4.1 Importer

Click 'Find my Laser' and LightBurn should detect the JCZ controller and add it for you. You will need to specify your field size (the size of your workspace), but this can be changed later too.

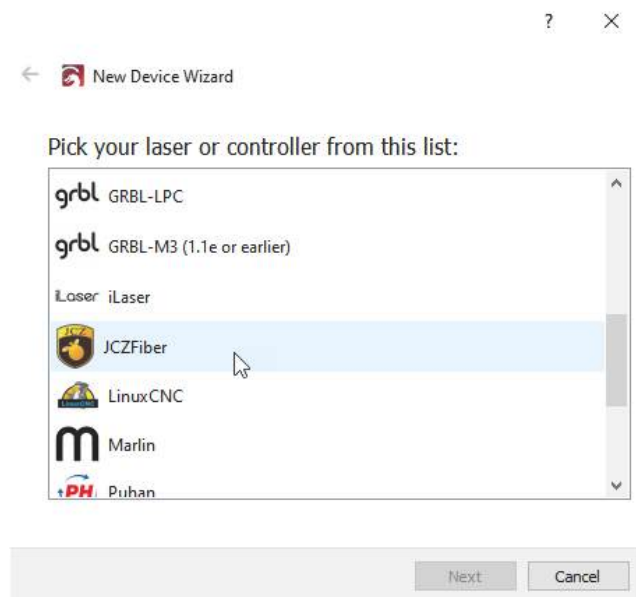

Select JCZFiber, click Next, and choose 'USB'. It's the only supported connection type for now.

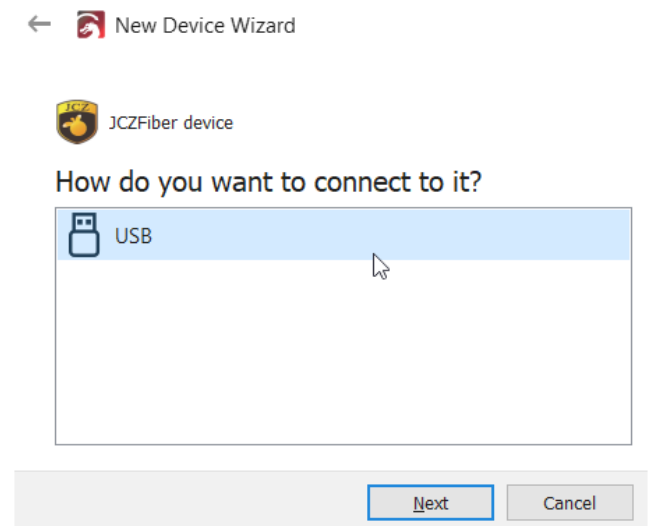

As with any other laser device, you'll need to enter your window size. (110mm x 110mm is common).

Before Import    After Import

?    X

←  New Device Wizard

To configure settings manually, skip the import and click next.  
To Import existing EZCad configuration follow these steps:

- Click the "Import" button below
- Navigate to EZCad application directory
- Open "plug" directory
- Select the correct markcfg file
- It is typically markcfg7

Import EZCad Config

Next

Cancel

New Device Wizard

**EZCad Config Summary:**

Click Next if settings are correct.  
Otherwise import another config or cancel.

- **Laser Type:** Fiber
- **Fiber Source Type:** IPG\_YLP
- **Field Size:** 110 mm
- **Enable PWM:** Yes
- **Min Freq:** 20 kHz
- **Max Freq:** 200 kHz
- **Enable Q-Pulse Width:** Yes
- **Open MO Delay:** 8000 ms
- **Galvo 1 is X:** Yes
- **Galvo 1 Negate:** No
- **Galvo 1 Scale:** 0.83011
- **Galvo 1 Bulge:** 1.03
- **Galvo 1 Skew:** 1
- **Galvo 1 Trapezoid:** 1
- **Galvo 2 Negate:** No
- **Galvo 2 Scale:** 0.77343
- **Galvo 2 Bulge:** 0.95
- **Galvo 2 Skew:** 1
- **Galvo 2 Trapezoid:** 1
- **Frame Speed:** 3000 mm/s
- **Red Dot Always On:** Yes
- **Red Dot Offset X:** 0 mm
- **Red Dot Offset Y:** 0 mm
- **Red Dot Scale X:** 1.01
- **Red Dot Scale Y:** 1.01
- **Red Dot Rest Pos X:** 0 mm
- **Red Dot Rest Pos Y:** 0 mm
- **Red Light Port:** -1
- **Start Marking Port:** 15
- **Ready Light Port:** -1
- **Ready Light High/Low:** High
- **Start Mark High/Low:** High
- **Red Dot High/Low:** High

Import EZCad Config

< Back

Next >

Select your configuration file from your EZCAD setup (or if you received a card, email, etc. with that information in it, please click "Next" anyways) It's likely to be on the USB drive you recieved from the manufacturer. Ours was in the "PLUG" folder of the "Ezcad2" install folder.

 Info

If your markcfg7 file includes information about **Lens Correction**, LightBurn will attempt to automatically import this for you. If your configuration doesn't, you'll need to manually enter it in **Device Settings** after finishing the New Setup Wizard.

?    X

←  New Device Wizard

**What would you like to call it?**

(If you have more than one, use this to tell them apart)

JCZFiber

**What are the dimensions of the work area?**

(The lengths, in mm, of the X and Y axis of your laser)

X Axis Length 110 mm Y Axis Length 110 mm

Next

Cancel

You'll need to enter the specific work area dimensions as selected by your manufacturer. While 110mm by 110mm is very common, the different models offered & their respective dimensions are usually listed on the manufacturer's website.

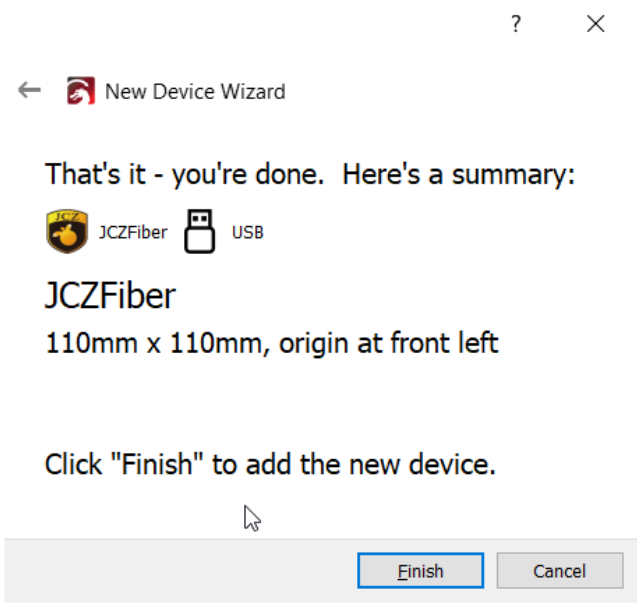

Just like that, you're all finished, and ready to start calibrating!

5.4.2 Manual Entry

If your laser did not come with the settings on a USB drive or if you don't have the USB drive available, you may need to contact the manufacturer for settings. Galvo settings can't be found through trial and error, due to the complexity and variety of machine configuration. Settings that work on one laser may destroy another.

If your settings were provided on a card, in an email, or in any other way that doesn't work with the automatic importer, clicking "Next" when asked to Import EZCAD Config will allow you to skip this step.

When in the main window, please open the "Edit" menu item, and select "Device Settings".

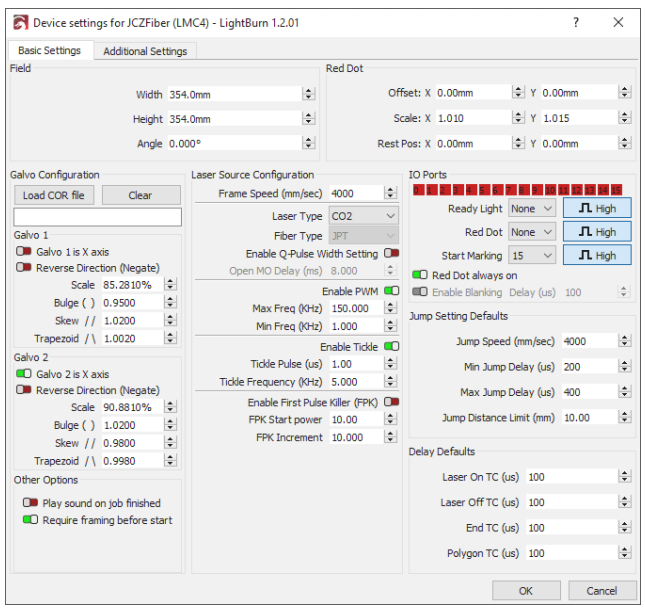

The settings can now be manually entered to match what was provided by the manufacturer.

Please note that when entering these settings manually, the **Additional Settings** tab needs to be updated with the correct information for the simulation in **Preview** to function correctly.

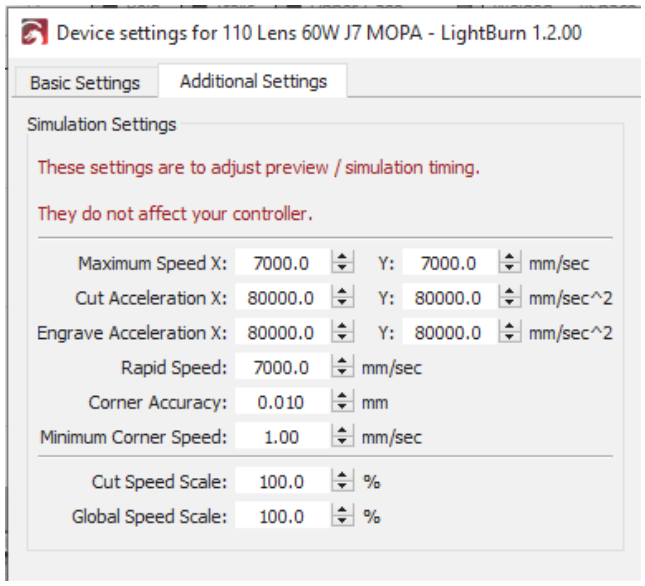

## 5.5 Configuring Galvo Settings

---

### Attention

This section is new, and is a work in progress. Be sure to let us know [on the forums](#) or via [support](#) if we need to change something. Thank you!

### Note

If you did the EZCAD parameter import as part of setting up the device, you can likely skip this part, though we do recommend verifying that everything came across correctly. If you didn't import your EZCAD settings, continue reading.

LightBurn needs to know more about your galvo laser before you can use it effectively. Below is an explanation of every currently

listed item in the Device Settings  for Galvo devices.

To expedite manual entry, you can either run EZCAD and just flip through the Param (F3) pages for this, or take screenshots and use them for reference when setting up LightBurn. All of these settings are taken directly from EZCAD.

Run LightBurn, choose the JCZFiber laser, then click Edit > Device Settings (or click Device Settings  on the toolbar.)

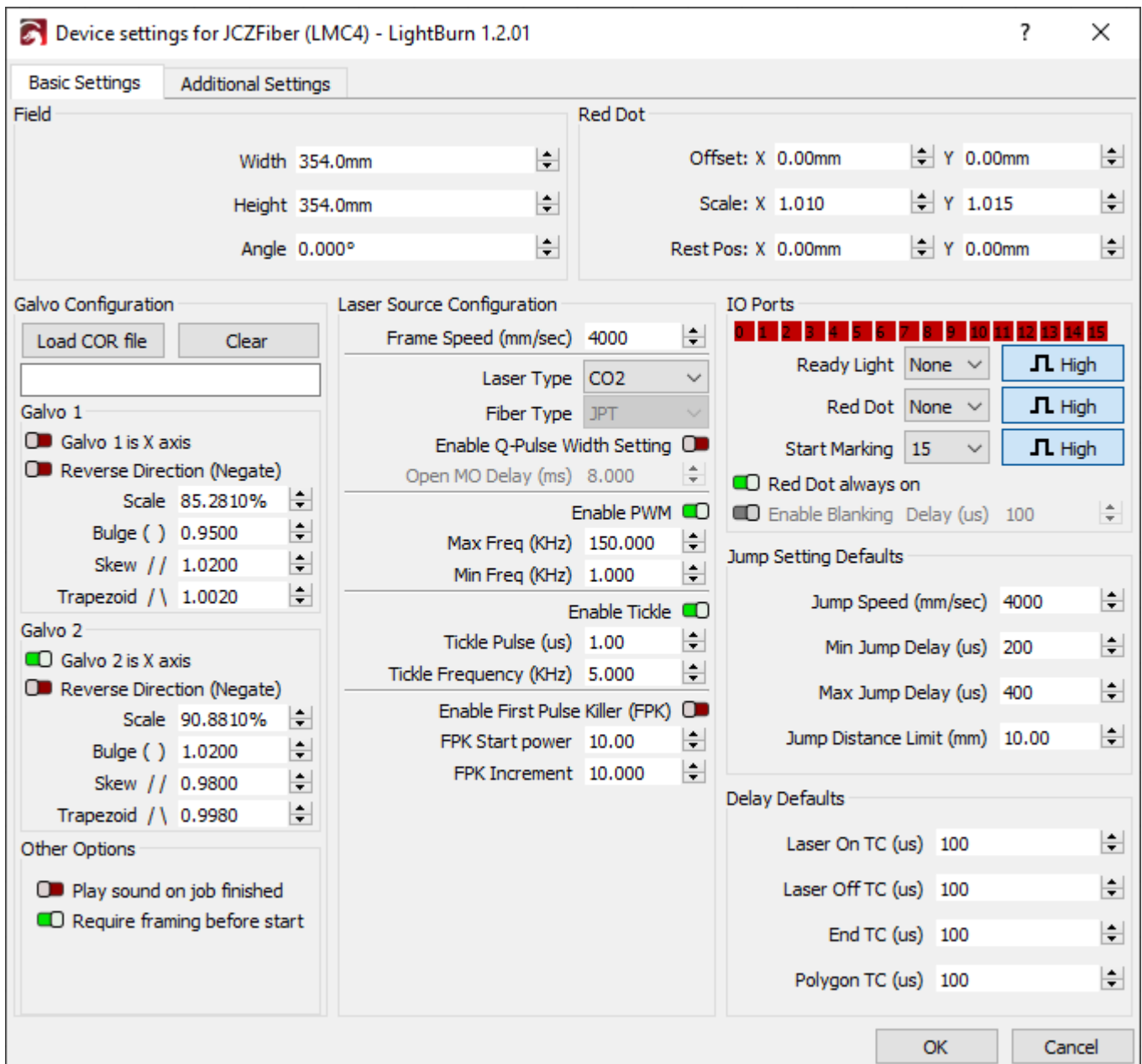

## 5.5.1 Basic Settings

### Field size

These fields describe the maximum area that the lens installed in the galvo can physically cover when focused. Changing the lenses always requires going through the setup and calibration to adequately tune and dial in galvos.

This value is also used to set up the work area in LightBurn, so that 1mm in LightBurn ideally translates to 1mm in reality.

### Angle

Rotational correction for the field - if you're correcting for a rotated galvo head relative to the physical fixturing pattern,

you can rotate it to behave as if it were square with this value.

### Red Dot

The red dot laser is a separate mechanism that is in line with the optics of your galvo laser source. It may require fine adjustment to get it aligned with those optics, and this is where those settings come from. While generally provided in the EZCAD Config during **Setup**, they may also be found in your installation media as a screenshot or other text file.

## 5.5.2 Galvo configuration

Load COR File - A COR file is an EZCAD lens correction file. LightBurn has the ability to import them and fill in the scale,

bulge, skew, and trapezoid setting automatically, and if you used the markcfg7 import during **Setup**, you'll already have these values/file set. Otherwise this field can be left blank, and entered manually in **Per Galvo Settings**

**Per Galvo Settings**

Each galvo head is responsible for an axis, and has fine-tuning that can be performed to get it operating optimally.

Galvo 1	
<input checked="" type="checkbox"/> Galvo 1 is X axis	
<input type="checkbox"/> Reverse Direction (Negate)	
Scale	100.0000
Bulge ( )	1.0000
Skew //	1.0000
Trapezoid /\	1.0000
Galvo 2	
<input type="checkbox"/> Galvo 2 is X axis	
<input type="checkbox"/> Reverse Direction (Negate)	
Scale	100.0000
Bulge ( )	1.0000
Skew //	1.0000
Trapezoid /\	1.0000

**Galvo (N) is X Axis**

This toggle is linked for both galvo mirrors, allowing you to specify which mirror is used for the X-motion of LightBurn.

**Reverse Direction (Negate)**

This flips the output behavior of an axis in the event the control signal is linked backwards to the motion of the mirror.

**Scale, Bulge, Skew, and Trapezoid**

A more in-depth explanation of the below settings can be found in the **Lens Correction** section.

**SCALE**

Percentage to scale the output axis by.

**BULGE**

Distortion near / at the center of the engraving field.

**SKEW**

Distortion at the edges (corners) of the fields, pulling the towards a cardinal direction.

**TRAPEZOID**

Corner tapering adjustment, to fix keystoneing.

**Play sound on job finished**

This feature mirrors that of EZCAD, causing the computer to play a sound when your current run is done, in lieu of all galvos having a window.

**Require framing before start**

This option forces the user to use framing mode and align their workpiece before engraving directly. It makes the Start Button in the **Laser Window** open the **Framing Dialog** instead.

5.5.3 Laser Source Configuration

⚠ Danger

All of these settings should be imported from EZCAD, manually changing them to "guess and check" settings is not the correct course of action. Doing so may damage your laser, proceed with caution!

Laser Source Configuration	
Frame Speed (mm/sec)	4000
Laser Type	Fiber
Fiber Type	RAYCUS
Enable Q-Pulse Width Setting	<input type="checkbox"/>
Open MO Delay (ms)	8.000
Enable PWM	<input type="checkbox"/>
Max Freq (KHz)	80.000
Min Freq (KHz)	20.000
Enable Tickle	<input type="checkbox"/>
Tickle Pulse (us)	1.00
Tickle Frequency (KHz)	5.000
Enable First Pulse Killer (FPK)	<input type="checkbox"/>
FPK Start power	10.00
FPK Increment	10.000

**Frame Speed**

This is the maximum speed of the red dot framing tool in your galvo.

### Laser Type

This refers to the specific type of galvo laser in use. Fiber or CO<sub>2</sub> are the current options.

### Fiber Type

The specific manufacturer, or granular type of laser. This may reveal other settings depending on what type and category of laser is in use.

### Enable Q-Pulse Width Setting (MOPA)

This is a MOPA specific laser setting to adjust the fine length timing of the pulses from the laser. The larger the timing, the less dense the pulse impact is.

### Open MO Delay (ms)

MOPA permits a wider frequency range comparatively to Q switch laser types, and this delay allows you to adjust this fine control.

### Enable PWM

This permits adjustment of the valid range of PWM timings on CO<sub>2</sub> galvo lasers.

### Tickle

CO<sub>2</sub> lasers require constant low power to be able to fire at lower power densities consistently and reliably. Use of a tickle permits adjusting the controlled location of that threshold to produce better lower power engravings.

These will be provided by your manufacturer.

### First Pulse Killer (FPK)

This setting is also CO<sub>2</sub> specific. To enable the initial power-on of a CO<sub>2</sub> tube, there's a higher power draw needed to energize it. FPK lets you choose and tune that first pulse to get to the normal operation energy.

This setting can be found via trial and error if needed.

## 5.5.4 IO Ports

These are external switches or features attached to the controller on the board.

The High / Low toggle indicates whether the device is normally high, or normally low electrically, and determines what signal to interpret as being toggled.

Not all of these may exist, or be enabled on all galvos. If not, the port number will be shown as "None".

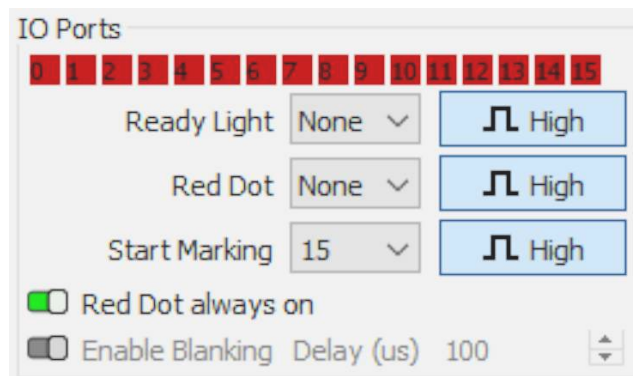

### Red 0 thru 15

These red/green rectangles represent the pin state of the Ezcad board inside your galvo laser at any given time, and the numbers the port number on the controller. This is useful for diagnosing floating electrical connections, loose wires, and a potential default setting dependent on a foot pedal.



Within LightBurn, a red indicator means the port is "LOW", or off, and green means the port is "HIGH", or on. Some manufactured boards are active LOW as opposed to active "HIGH". If all ports are green by default, you'll likely need to change your trigger type to "LOW" from HIGH.

### Ready Light

This is the selector to toggle LEDs on the galvo head, aimed at the workpiece.

### Red Dot

This is the selector for the external Red Dot enable.

### Start Marking

This is the selector for starting an engraving job as set up, typically triggered with a foot switch of some kind on the laser. Like mentioned in [IO Ports](#), a user can change the pin number to match that of the board's foot pedal or start signal, the signal trigger type, or disable it entirely. The former is useful to use a foot pedal; the latter for safety.



**Danger**

If you find your laser activating sporadically and you do not use a foot pedal, it is a heavy suggestion that the "Start Marking" pin is set *explicitly* to disabled. Some galvo controllers do not adequately electrically protect the circuit and stray voltage and static can mark the pins as HIGH, or "on" to LightBurn.

LightBurn has debouncing in software to mitigate this as much as possible in 1.2.02. Please update to 1.2.02 or later to ensure you have this functionality automatically in place.

**RED DOT ALWAYS ON**

This setting forces the external red dot alignment to "always be on", permitting constant use or disabling it if desired.

**ENABLE BLANKING**

This options allows you to attempt to turn off the red dot internal to your galvo between drawing shapes. This is not supported on all devices.

5.5.5 Jump Setting Defaults

These settings control the speeds by which to toggle, offset, delay, or fudge the source enable and galvo head motion.

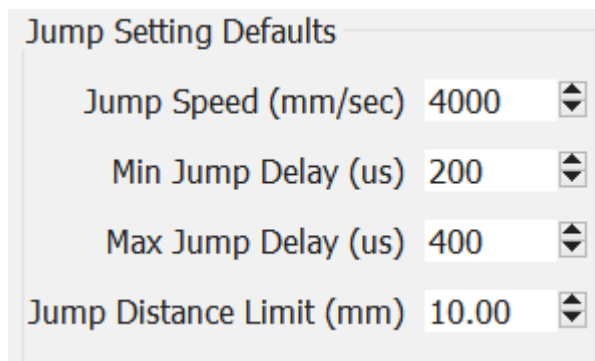

**Laser on TC (µs)**

When attempting to mark, the physical mirrors of the galvo head must reach the desired speed before they begin marking. This fine tuning allows the user to reduce the burn-in potential during that initial acceleration by adjusting the source timing.

**Laser Off TC (µs)**

Similarly to the above, when the mirrors of the galvo head must slow down as they attempt to end a marking move, there may be a burn-in effect while slowing down. This setting allows the end timing to be adjusted finely.

**End TC (µs)**

This setting adjusts how long the laser waits at the end of a series of vectors. Due to the fact the laser will physically lag

behind the commanded state as decided by any software, this delay permits adjustment similarly to the **Laser Off TC**.

This setting applies to *any* marking move where the laser is turned off after execution.

**Polygon TC (µs)**

This setting adjusts how long the laser "waits" at the end of each segment of a polygon, permitting the laser to settle appropriately, compensating for the same lag as outlined in **End TC**. This adjustment will *only* apply to polygonal execution.

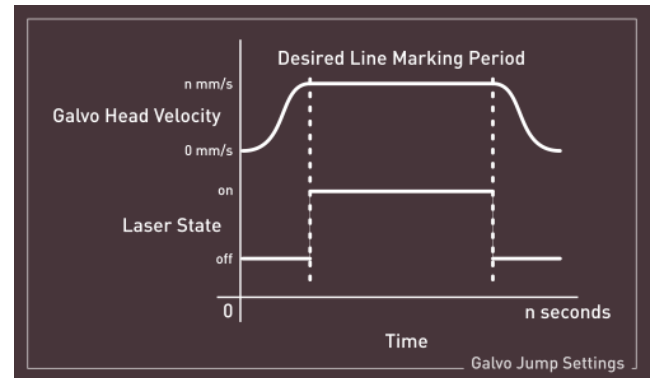

5.5.6 Additional Settings

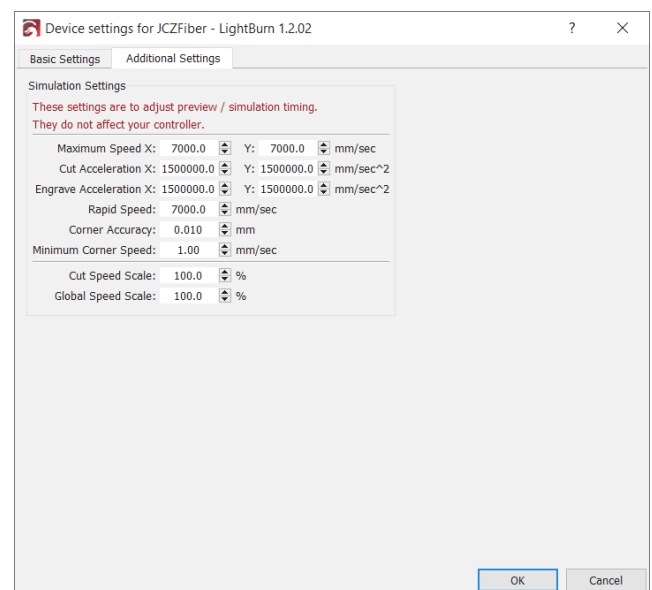

This settings tab consists of specific timing adjustments for simulation and preview, entirely for the **Preview Window**. The galvo can function even if these are set incorrectly, so long as the other timing and adjustment are correct.

If the estimate is significantly off from the timings in practice, we recommend editing these settings to match the

main device settings .

## 5.6 Lens Correction

### Attention

This section is new, and is a work in progress. Be sure to let us know [on the forums](#) or via [support](#) if we need to change something. Thank you!

Much in the same way that cameras used in LightBurn need to have a calibration routine run for best performance, so do galvo lasers. Many manufacturers ship lasers with these types of settings already present, and when using the importer these should be automatically imported for you.

If the LightBurn Importer does not detect the lens correction setup when following the wizard, *these specific settings* may be copied from EZCAD's Configuration Parameters tool, or found by the user manually. Device Settings otherwise *must* come from the manufacturer for safety, as outlined in [Setup](#).

### 5.6.1 Field Size

While not strictly part of the lens correction, the intended field area affects all of the correction and calibration settings described below. The field size describes the maximum area the lens can reach at it's focal length. When correcting a new lens, be sure to follow the steps suggested [here](#).

### 5.6.2 Scale Adjustment

This setting scales the overall size of your intended laser output on X & Y axes. If adjustment of this is needed, please also verify that your [Machine Setup] was finished and your field size was imported. Otherwise, you may be compensating for the field size in the wrong area, complicating further adjustments.

### 5.6.3 ( ) Bulge Adjustment

The bulge factor allows you to change by how much (if at all) the center of shapes are distorted and stretched.

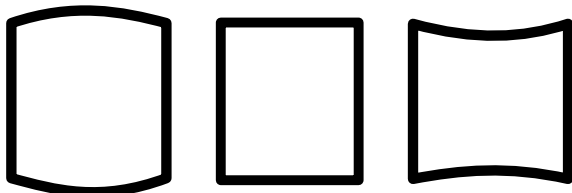

### 5.6.4 // Skew Adjustment

The skew factor allows you to adjust the tension on the corners of your design, pulling the bottom portion of the design left or right relative to the top.

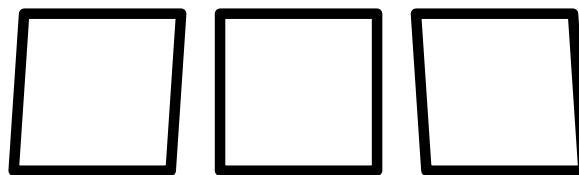

### 5.6.5 / \ Trapezoid Adjustment

The trapezoid tool works similarly to the Skew adjustment tool, where it permits the distortion of your design by stretching or pinching the "corners" of your design. Trapezoid adjustment allows you to pinch one portion relative to another. This is where the name of the tool comes from, as it allows you to make trapezoids into squares, and vice versa.

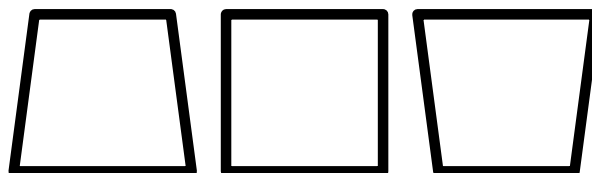

## 5.7 Framing

### Attention

This section is new, and is a work in progress. Be sure to let us know [on the forums](#) or via [support](#) if we need to change something. Thank you!

Framing mode is a function of Galvo lasers that permit you to preview the outline of your design on your physical object before engraving it. Clicking the 'Frame' button in the Laser window, or pressing 'F1' brings up the Framing Mode window.

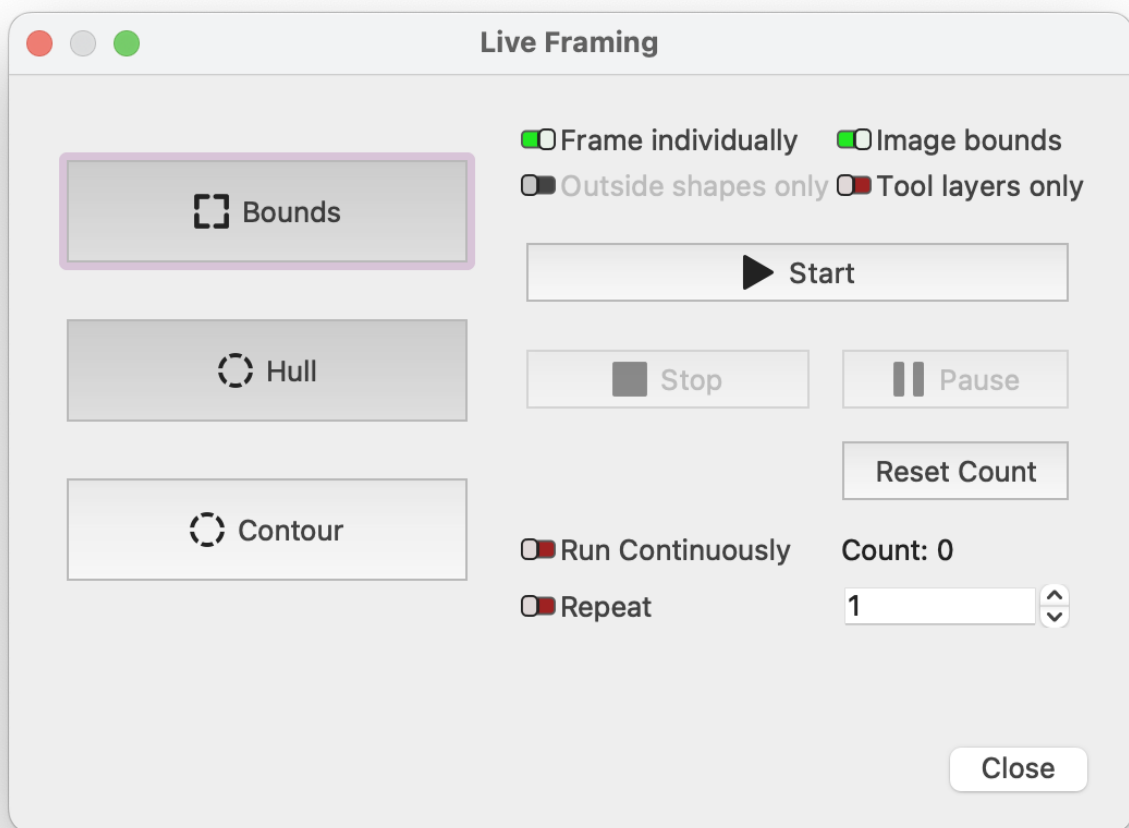

The different options allow you to choose how accurately the red-light frame represents your shapes, and which shapes are shown.

#### BOUNDS

This mode is a simple rectangle, drawn just big to enclose your shapes. It is extremely fast, but doesn't represent complex shapes well.

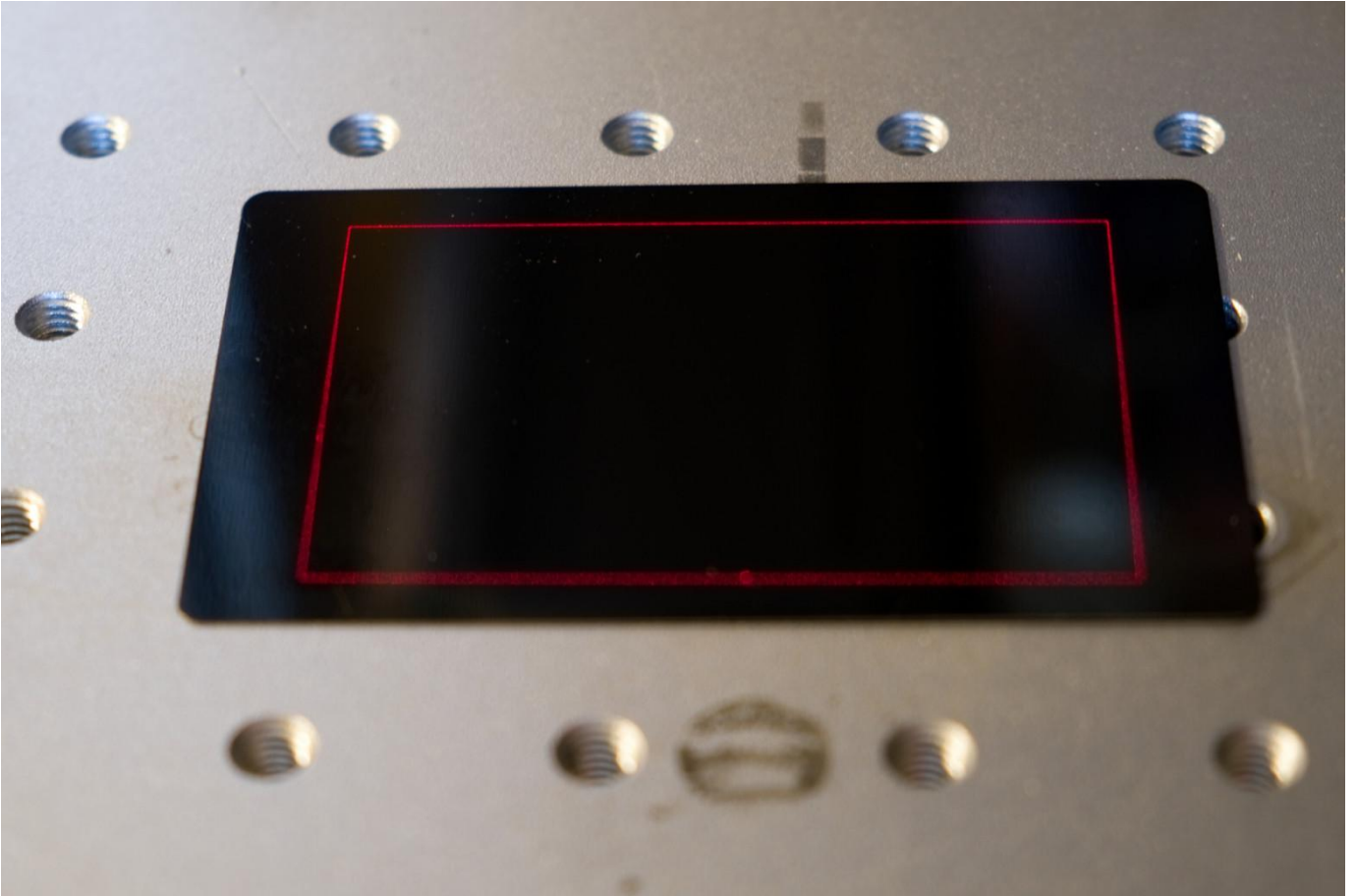
**HULL**

The 'hull' is what you'd get if you stretched a rubber-band around your shapes. It is nearly as fast to draw as the rectangle bounds, but gives a much closer fit for rounded or smooth shapes.

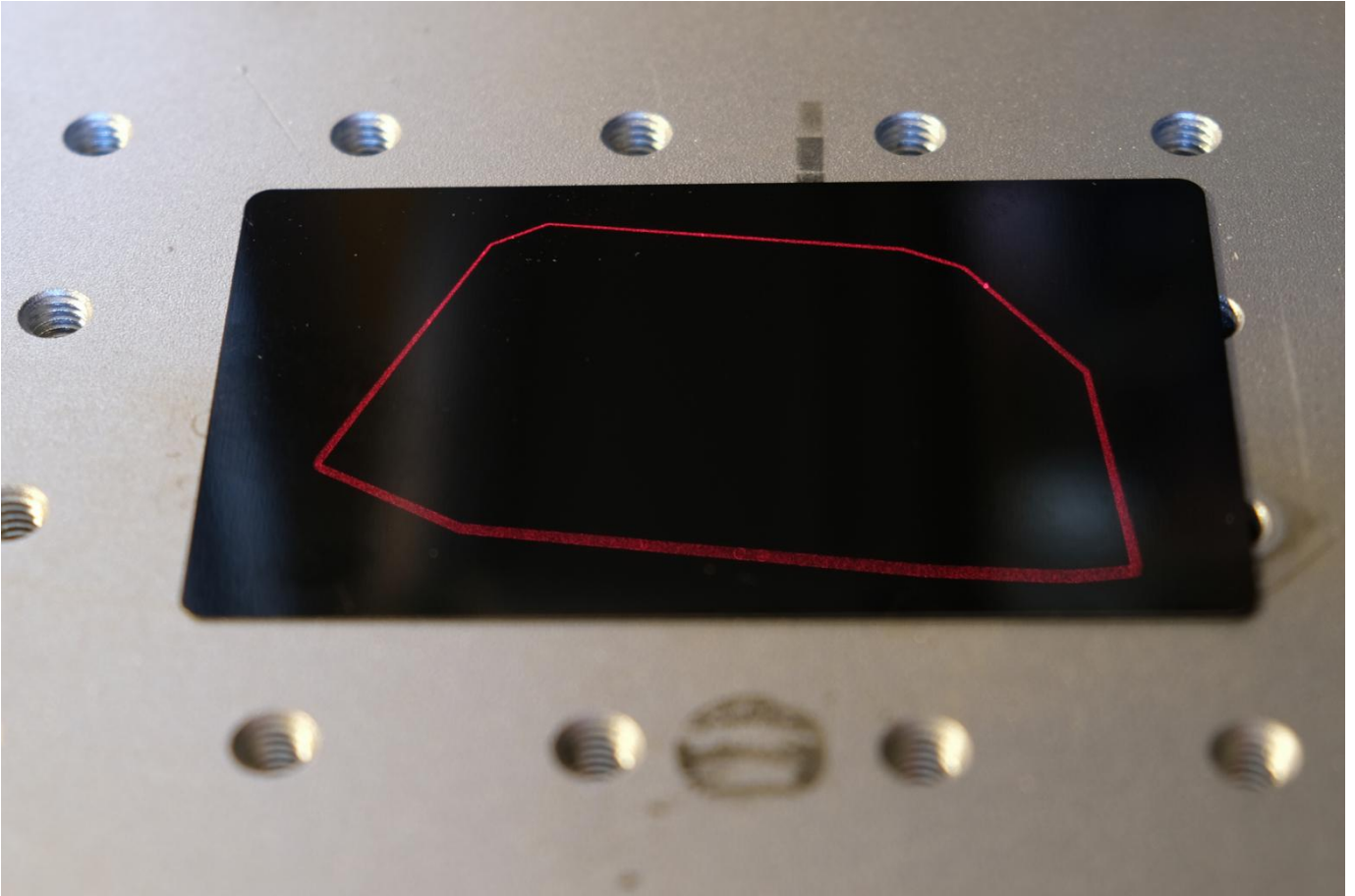

**CONTOUR**

Contour follows the exact contours of your shapes - it takes the longest to draw, but it's the most accurate.

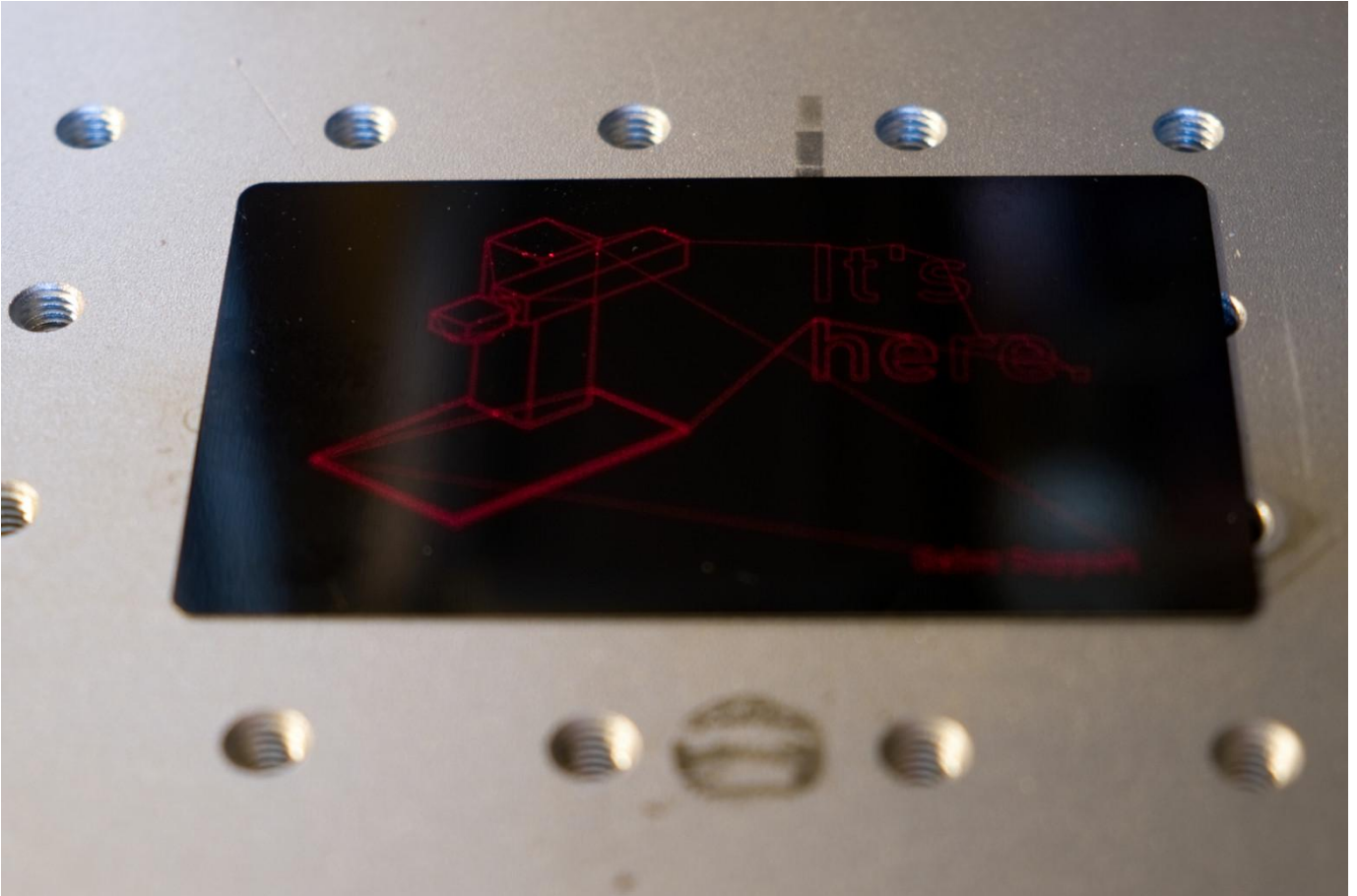

#### FRAME INDIVIDUALLY

This toggle switch indicates whether you would like to draw a single bounding box or hull around everything together, or around each shape in turn (this only affects **Bounds** and **Hull** modes).

#### IMAGE BOUNDS

Enabling this toggle switch attempts to quickly trace the outlines of any images you have in your design, rather than simply showing the rectangular boundary of the entire image.

#### OUTSIDE SHAPES ONLY

This toggle switch tells the software not to trace inner shapes, like the insides of letters - Typically this doesn't affect placement, but allows a faster update of the frame (this only affects **Contour** mode).

#### Nudging

While framing, the arrow keys can be used to nudge the position of your graphics by 1mm. Holding Shift will increase the movement distance to 5mm, and holding Ctrl will decrease it to 0.2mm.

#### Job Counter and Multiple Runs

##### COUNT

This value is incremented at the end of each successful run of your file. You can use this to keep track of how many parts you have marked, or how many passes of a single job you've run. Press the **Reset** button to reset the count back to zero.

##### RUN CONTINUOUSLY

Turning on this switch will make LightBurn re-start the job automatically after it finishes, and will update the run counter after each run. This is useful when you are doing very deep engraving, and are unsure how many passes a job will need. If you turn off the switch while a job is running, it will stop when the current run completes.

**Warning**

Please ensure your laser is properly supervised, even during long jobs with multiple passes.

**REPEAT**

Turn on this switch and set the repeat count value to run the entire job a specific number of times. This is similar to 'Run Continuously', except it will stop when it reaches the repeat count. If you turn off this switch while a job is running, it will stop when the current run completes.

## 5.8 Lens Focusing & Calibration Tools

### Attention

This section is new, and is a work in progress. Be sure to let us know [on the forums](#) or via [support](#) if we need to change something. Thank you!

### Danger

Any use of a laser, as outlined in this section, requires effective and useful laser safety glasses calibrated to your galvo's output wavelength range.

Laser safety glasses should come with the wavelengths they protect against permanently marked on the glasses themselves.

To be able to use your galvo laser effectively, you'll need to have it in-focus, well tuned, and well calibrated. This enables best use of features like [Cylinder Correction](#), [3D Sliced Engravings](#), and more.

### 5.8.1 Finding Your Focal Point

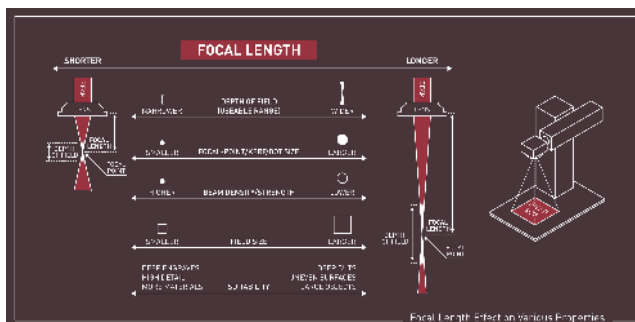

Each lens should be labeled with a focal length, such as F330 for 330mm lenses or F160 for 160mm lenses. This is a good starting point for focusing, but manufacturing differences result in differences between lenses so you should still fine-tune the focus. You can fine-tune the focus by looking for crisp outlines in framing or listening for audio cues.

To use "crisp outlines" to find the focal length, you'll need to frame a design and raise/lower the galvo until the edges are as crisp as possible. This requires your galvo to have an in-line red dot. With audio cues, you'll instead listen for louder burning or sizzling noises while the job is running. The correct focal length will generally make the loudest sounds.

While the depth of field is a range that produces engraved results, finding the optimal focal point within that field is important, to ensure the best results, and is best found through trial and error.



#### A Step-By-Step for Focusing Flat Objects

1. Raise your galvo head as high as it reasonably can go.
2. Start a repeat engraving.
3. Lower the head until it starts making noise.
4. Continue further down slowly until the engraving noise is as loud as it gets.
5. If the noise tapers off, raise it back up and fine tune based on that.



6. Your flat surface is now focused!
7. If your laser has two-diode red-points that are manually moved, re-adjust those at this point. See your laser's user manual for help.

## 5.8.2 Measuring Focal Length

---



Make sure you keep track of what part of the laser your focal length is measured to! You might find it convenient to measure to a point other than the bottom of the lens, and that's fine as long as you keep measuring to the same height.

Accurately measuring the focal length above is a useful process to speed up swaps of different and diverse jobs, given the lens. Use an acrylic ruler (preferably one with the edge of the ruler starting from 0"/0mm), to measure up to the point the ruler meets outside lip of your lens.

If your acrylic ruler has a lip, you can measure the offset with calipers to produce the formula needed to measure the focal length accurately.

To make it quicker and easier to focus the laser when working with objects of different sizes, it's a good idea to make a tool that you can place between the lip of your lens and your object, so you can easily raise/lower your galvo head to it. This can be as simple as a dowel of the right length marked to indicate which lens it goes with (if you have multiple lenses). Another popular option is to laser cut an acrylic focusing tool for the size you need.

### Video Guide For Focus Sticks

## 5.8.3 Focusing For Cylinder Correction

---

Cylinder correction within LightBurn maximizes the depth of field usable for engraving by *intentionally* defocusing your laser. See [here](#) for more information.

Galvo LightBurn 1.2 Advanced

## 5.9 Cylinder Correction Marking

### ⚠ Attention

This section is new, and is a work in progress. Be sure to let us know [on the forums](#) or via [support](#) if we need to change something. Thank you!

Cylinder Correction (called ProjectMark in EZCAD) warps the output of your design to correct for the expansion that happens when you mark on a cylindrical object, like a cup or tumbler, without using a rotary.

### 📝 Note

This feature is currently only available on galvo machines. While it is on the roadmap to enable this functionality for DSP and GRBL, this will not present itself on DSP or GCode machines until that change is made.

### Theory

In the image below, the blue shapes represent a rectangle. If you were to project a rectangle directly onto a cylinder, the sides of the rectangle would hit the cylinder at a lower point than the middle. Since the laser is projected from a single point above your object, the extra distance means the sides of the rectangle will widen and curve, like the rectangle below labeled "Uncorrected".

With Cylinder Correction mode enabled, LightBurn will alter the data sent to the laser to compensate for this. LightBurn sends something similar to the "Corrected" image, and when engraving your object, the effects negate each other. This produces crisp, significantly less distorted results, like the "Result" shape shown below.

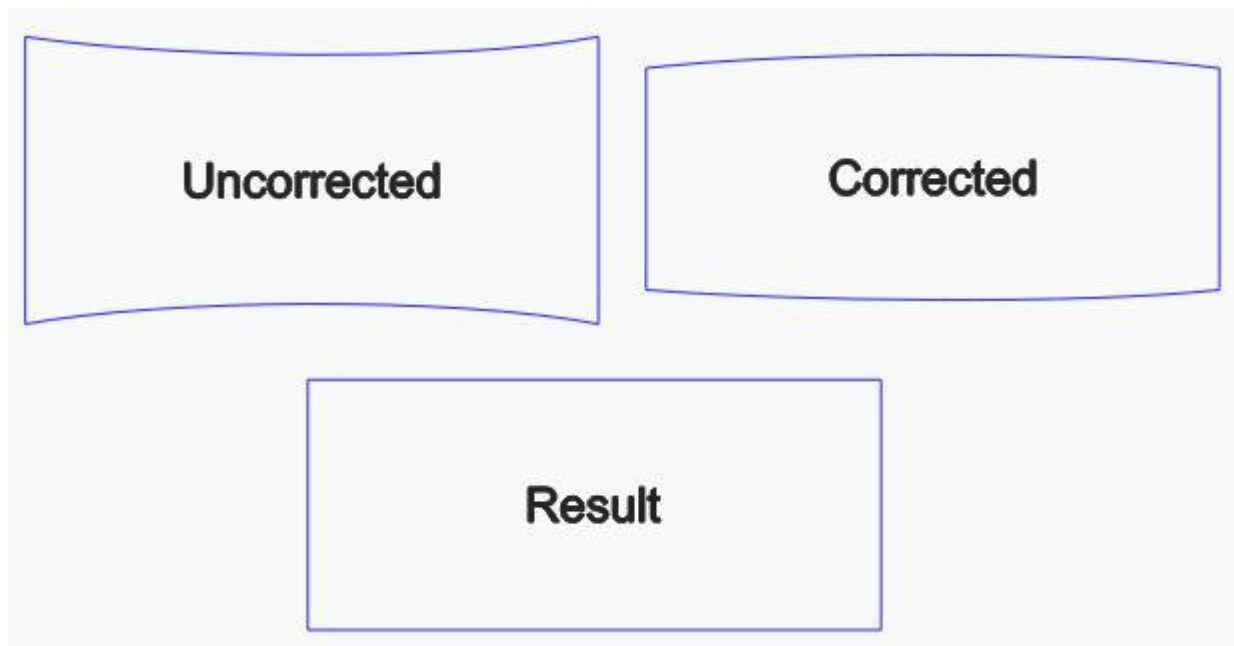

### Lens Selection

Using this feature is dependent on being able to make a mark on your target object across a potentially wide focal range. For example, if you have a 75mm diameter tumbler and are engraving a 50mm wide graphic, there will be a roughly 10mm difference in focal distance from the center to the edge of that graphic.

Due to this, you will want to select a lens that has a wider "field" (working area) for your galvo laser. For example, a 110mm field lens (f=160mm) may only have a workable focal range of around 1.5-2mm. However, a 300mm field lens (f=430mm) should be able to handle a 10mm range relatively easily.

You will also want to focus your lens partway into the surface of your cylinder, to take advantage of the full depth of field of your lens, as described in the image below.

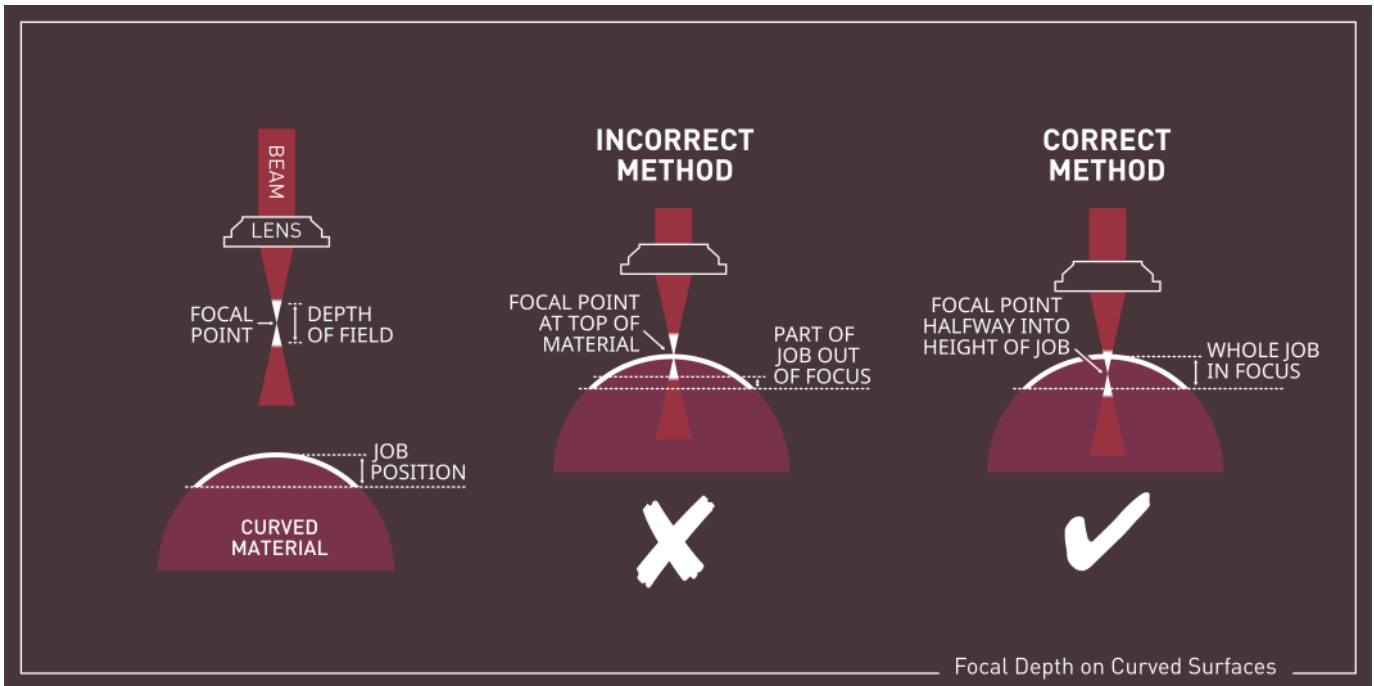

### Design Placement

LightBurn will always assume that the center of the provided shapes are at the center of the object you are engraving on. This includes if you are using `Cut Selected Shapes` - where it will base the center calculation on only those shapes. It is done this way so that you do not have to always place your object exactly at the center of your machine working area. If, for example, your placement jig has to be 20mm off center due to the threaded grid holes being off center, you can simply adjust your design to be 20mm off center to match. You can, of course, verify the correct placement using the framing option in the `Laser` panel.

This assumption is made because if the object is off center from the actual galvo center, the laser can physically reach more of one side of that curved surface than the other. LightBurn will actually warp each side of your design more or less according to this offset.

It also affects the **valid boundary** in which your design can be placed for a given mirror distance and object diameter.

### Setup

To enable it, go to `Tools > Cylinder Correction Setup`, and you'll be shown this screen:

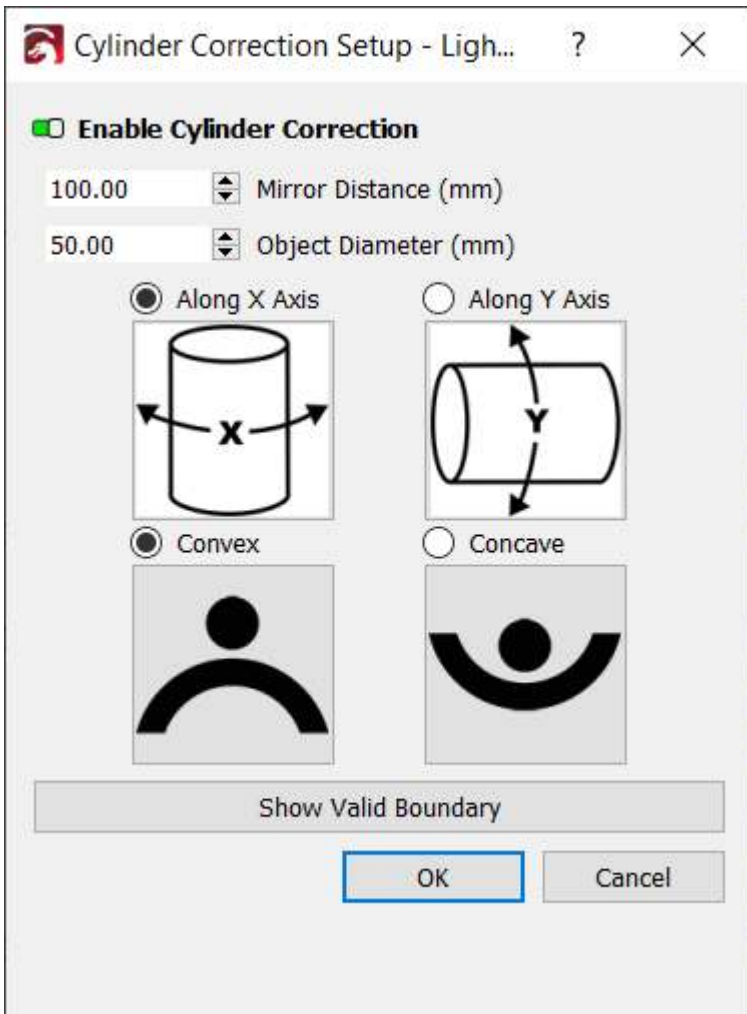

Start by toggling the "Enable Cylinder Correction" option at the top. Note: this is not preserved across LightBurn sessions like it is for some rotaries. You will have to re-enable it any time you restart LightBurn and would like to use this feature.

Next, set your mirror distance from the surface of your object. Note: this is **not** the focus distance from the lens, but actually to the mirrors. It is relatively easy to find this distance however. There is typically a tube connecting the galvo head to the laser source and the mirrors are generally centered along that tube.

In the image below, you can see the center plane of that tube marked along with the distance from the bottom of the lens to that center plane marked. Assuming you measure your focus distance from the bottom of the lens to the surface of the object, simply measure the distance from the bottom of the lens to the center plane of the tube and add that to your focus distance. Use that value for the mirror distance.



Finally enter your object diameter and choose the axis along which your target object curves.

### Valid Boundary

Given that the laser is being projected from a fixed point onto a curved surface, there are limits to where on your engraved object your laser can actually reach.

In the Cylinder Correction Setup dialog, shown above, there is a `Show Valid Boundary` button at the bottom. Click on this and it will insert a rectangle, on the T0 tool layer, into your design, showing you the area in which your design can be placed.

This valid boundary area is also affected by how far from center your object is.

If you attempt to run an cylinder corrected engrave or even show the preview while your design is outside of this boundary, you will be presented with the following dialog:

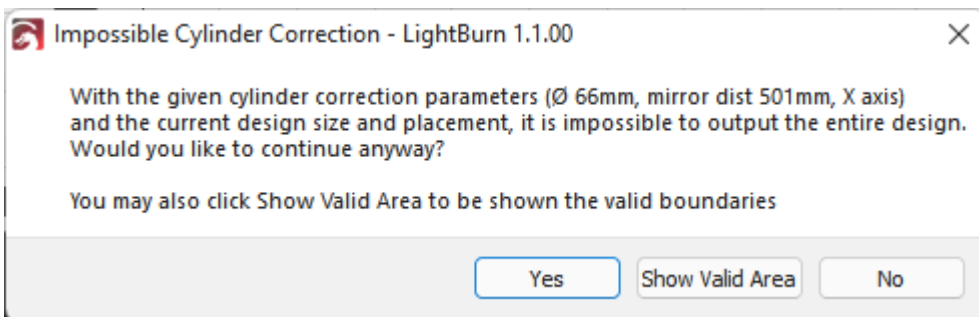

If you choose to continue anyways, the areas outside of the valid boundary will be automatically cut off from the output. In the image below you can see it has actually removed the portions outside of the valid boundary area, shown in orange at the left.

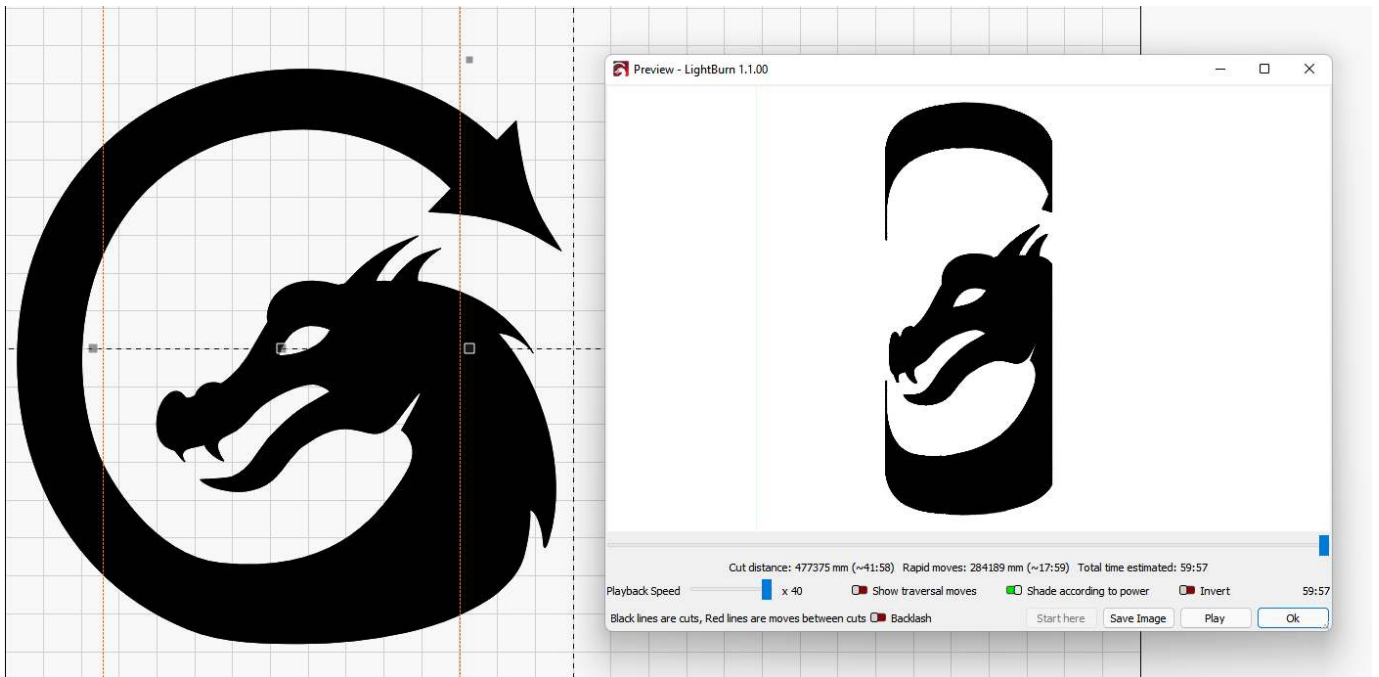

You can also, from that dialog choose to have it show you the boundary just as you would in the setup dialog.

### 5.10 LightBurn Fill & EZCAD Hatch Quick Translation

**Attention**

This section is new, and is a work in progress. Be sure to let us know [on the forums](#) or via [support](#) if we need to change something. Thank you!

If you're coming from EZCAD and having trouble finding hatch settings you're used to, please see below for a guide to matching your usual hatch settings to LightBurn's fill settings.

If you're not sure how to adjust cut & engraving settings, please see the [Cut Settings Editor](#) page.

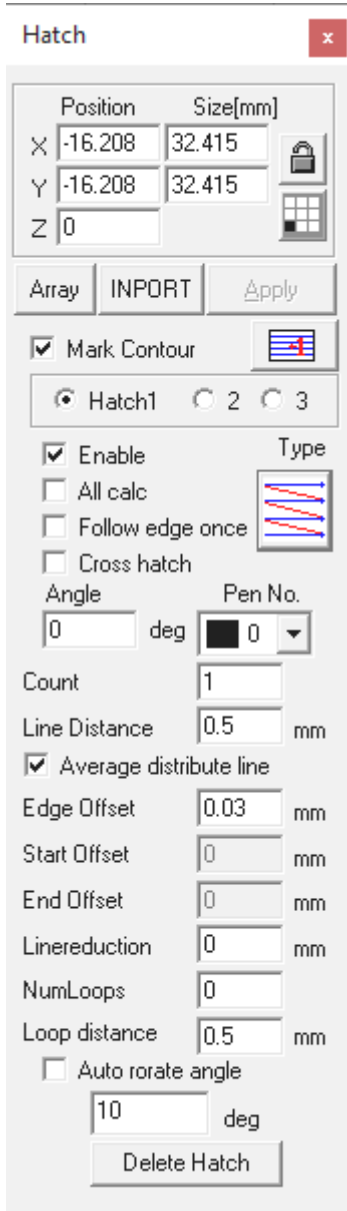

### 5.10.1 Mark Contour

EZCAD2's "Mark Contour" option can be replicated with LightBurn's **sub-layers**. By creating a line sub-layer and a fill sub-layer, you can achieve the same effect. To cut the contour first, have the line sub-layer as the first sub-layer. To fill first, have the fill sub-layer as the first sub-layer.

### 5.10.2 Hatch 1, Hatch 2, Hatch 3

EZCAD2 allows for three different hatches on the same geometry. This is equivalent to LightBurn's **sub-layers**. Please see the relevant page for help.

### 5.10.3 Cross-Hatch

This functionality is the same between the two programs, and is a checkbox in both.

### 5.10.4 Hatch Patterns

#### Unidirectional hatch & Bidirectional hatch

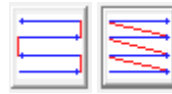

EZCAD2's bidirectional hatch and unidirectional hatch are the same as the default hatch in LightBurn, with the **bi-directional fill** toggle either on or off.

#### Ring-like hatch / Pyramid Hatch



EZCAD2's ring-like hatch is equivalent to LightBurn's **Offset Fill**.

#### Snake Hatch

Snake hatch is equivalent to a regular fill in LightBurn with **Flood Fill** enabled.

#### Auto Rotate Hatch Angle

In LightBurn, the EZCAD2 feature of "auto rotate hatch angle" is labeled as "Angle Increment" in your **layer / sub-layer settings**. While not a fill mode, it's still relevant to replicating EZCAD2 fill styles.









**Galvo**   **LightBurn 1.2**   **Advanced**   **Rotary**

## 5.11 Rotary Setup (Galvo)

---

### Attention

This section is new, and is a work in progress. Be sure to let us know [on the forums](#) or via [support](#) if we need to change something. Thank you!

The Rotary Setup can be found on the toolbar with the rotary icon, in the "Laser Tools" menu near the bottom, or brought up by using  +  +  /  +  + .



Chuck    Rollers

Rotary Setup - LightBurn 1.2.00
?    X

**Rotary Type**

Chuck

Roller

Enable Rotary

Reverse Rotary Direction

Return to starting point

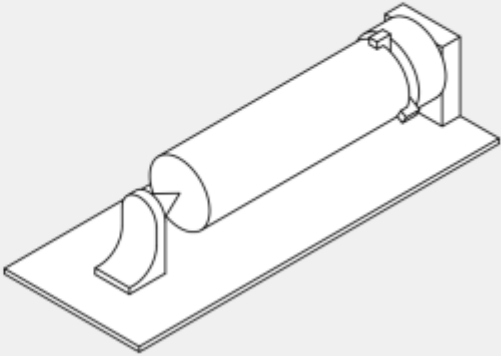

**Split Setup**

5.00  Split size (mm)

0.10  Overlap (mm)

**Rotary settings:**

5000.0  steps per rotation

50.000mm  Object Diameter

157.080mm  Circumference

**Rotary Axis**

X Axis

Y Axis

Test

**Motor speed settings:**

500  Min Speed (pulses/sec)

3000  Max Speed (pulses/sec)

100  Acceleration time (ms)

3000  Return speed (pulses/sec)

Rotary Setup - LightBurn 1.2.00
?    X

**Rotary Type**

Chuck

Roller

Enable Rotary

Reverse Rotary Direction

Return to starting point

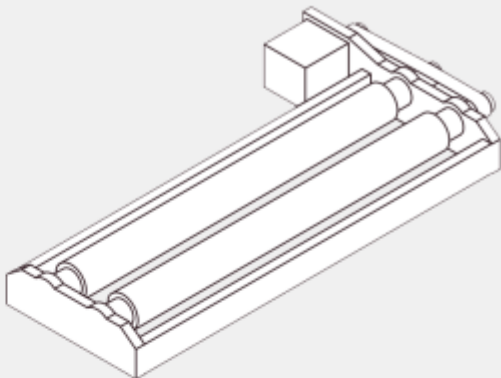

**Split Setup**

5.00  Split size (mm)

0.10  Overlap (mm)

**Rotary settings:**

5000.0  steps per rotation

50.000mm  Roller Diameter

With a roller rotary, the next two values are not used. This is provided as a helpful calculator.

50.000mm  Object Diameter

157.080mm  Circumference

**Rotary Axis**

To use the rotary with your marking laser, you first need to set up the rotary parameters.

#### Note

When rotating about the X axis, you'll want to engrave along the X axis (with a resultant **scan angle** of 0 or 180). When rotating about the Y axis, you'll want to engrave along the Y axis (with a resultant scan angle of 90 or 270).

1. First choose whether you have a chuck or roller style rotary.
2. Set the 'Steps per Rotation' value to the number of motor steps required to spin the rotary itself one complete rotation when the 'Test' button is pressed. (it should rotate a full 360 degrees, pause, then rotate back to the starting point).
3. Set the Min and Max speeds to move the rotary, in pulses per second.
4. Set the Acceleration time (the time to ramp the speed from Min to Max speed).
5. Set the Return speed value (this value is how fast to move when returning to the starting point)
6. Choose whether you are rotating around the X or Y axis. (If the roller is along the horizontal axis, choose X, if it's along the vertical axis, choose Y)
7. You may need to enable the 'Reverse Rotary Direction' switch if the output is backwards or sliced in the wrong order.

#### Note

In most cases, the steps/rotation and other values will be provided by the manufacturer of your machine, either as a screenshot of the rotary params page in EZCAD or a text document.

If you don't know the correct numbers, the 'Test' button in LightBurn will run a single 360 degree movement of the chuck or roller, pause, and return to zero, using the current settings, so it is possible to find usable values by trial and error.

The values listed above, minus object diameter/radius, should only need to be set up once. If the rotary unit or orientation are changed though, performing Rotary Setup again is a good practice.

## Split Setup

Galvo markers will run a portion of the job (a slice), rotate the object, run another slice, and so on.

### SPLIT SIZE

The size of each slice is called the 'Split Size'. If your object is tapered, irregularly shaped, or not perfectly aligned with the rotary axis, using a small split size can help reduce gaps or misalignment of the splits.

A larger split size will reduce the time spent running the job, but can be harder to dial in the settings such that no overlaps or gaps are visible.

### OVERLAP

To help eliminate visible gaps between slices, you can tell LightBurn to overlap them - specifying an overlap of zero means that each slice is run on its own. A non-zero overlap value will produce that much overlap on the ends of each slice, like this:

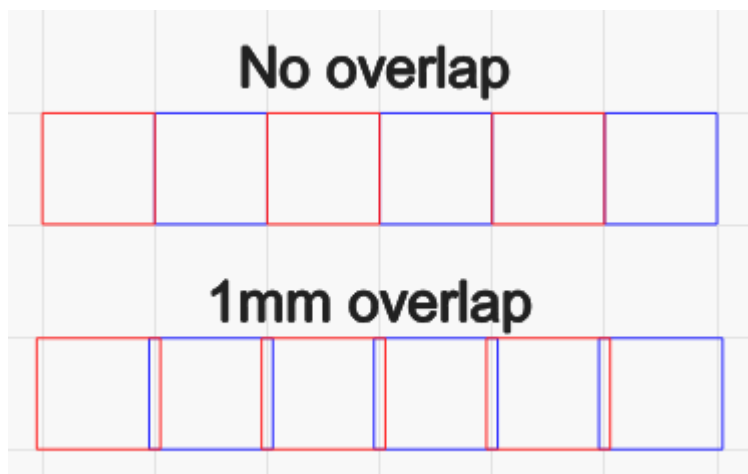

If you are removing paint, anodizing, or other surface coating, using a small overlap is recommended. If you are annealing or marking the material directly, adding overlaps could produce visible artifacts.

#### RUN WHOLE SHAPES

When 'Run whole shapes, if possible' is turned on, LightBurn will attempt to create splits that keep shapes intact. This can produce a higher quality finish without gaps or misalignment within shapes.

#### Running the job

When rotary mode is enabled, pressing the **Start** button on the main window will bring up the Rotary Marking window, shown here:

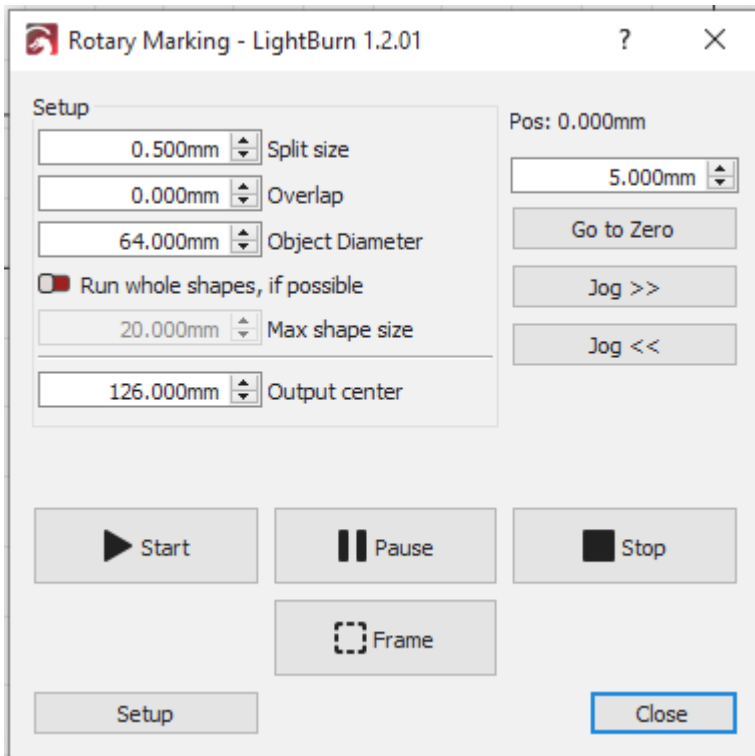

From here you can tune the split size, overlap, and object diameter, as well as jog the rotary, and run the job. When running a rotary job, the center of your page is treated as the current rotary position when you clicked 'Start'.

#### OUTPUT CENTER

This setting allows you to offset the "center" if your rotary workspace on the axis it's setup for. This can be used to compensate for your rotary not being aligned exactly to the edge of the laser workspace. This setting can be both negative and positive, and the "center" will be half of that axis' size in the **Field Size** setting.

#### Note

This setting is only adjustable (as of 1.2.01) in the Rotary Marking "Run" window, and *not* the "Framing" window. If you wish to retain use of the Framing dialog, you can set it here, and then use "Frame" all the same.

#### Focusing

See [Focusing](#) for more information.



## 5.12 Changing A Lens

### Attention

This section is new, and is a work in progress. Be sure to let us know [on the forums](#) or via [support](#) if we need to change something. Thank you!

To ensure best performance following a lens swap in LightBurn when using a galvo, there are several changes and settings you'll need to confirm first. Some manufacturers give you the calibration information for your new lens, and it's highly suggested you check their website before proceeding to find this manually.

### 5.12.1 Physical Lens Swap

This video guide from Laser Everything covers the physical installation of the lens, as well as many of the items outlined below with EZCAD analogues. It's suggested this video by [Laser Everything](#) is reviewed to help ensure the lens swap doesn't damage your machine or hurt you in the process.

### 5.12.2 Duplicate Original Laser

In many cases, changing the galvo lens means that you'll need to adjust many settings and recalibrate it, making it a "new" machine when doing so. To duplicate a laser device in LightBurn, click "Devices" in the "Laser" window, and right click on the given laser to duplicate it.

Be sure to give the duplicate a descriptive and accurate name to contrast it to the original, and ensure that's the one you'll be editing.

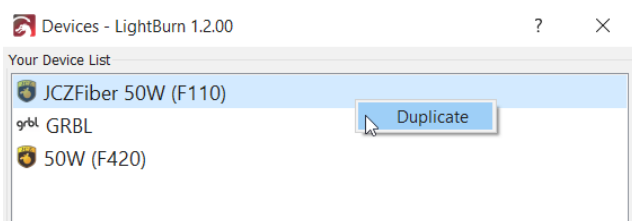

### 5.12.3 Field Size

When changing lenses, the effective Field Size of your laser will also change. The Field Size for your lens is usually listed on the manufacturer's website.

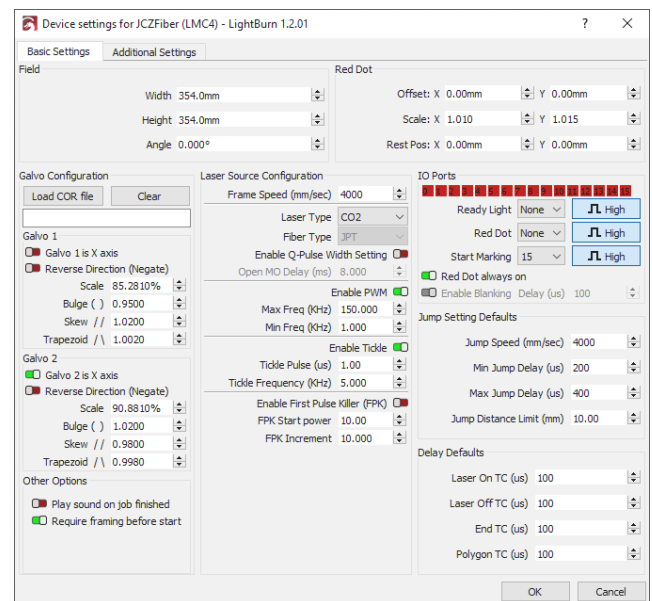

### 5.12.4 Focus

After changing lenses physically, you'll need to adjust the focus of the laser even without other calibration being done yet to ensure the results are as good as possible.

Spend time and reference the steps outlined in [Focusing](#) to ensure your galvo's output is crisp and in focus; keep in mind your red dot framing may no longer be in focus due to the focal length changes.

### 5.12.5 Scale, Bulge, Skew, Calibration

Once your galvo is focused, you'll need to adjust the bulge, skew, trapezoidal calibration as best you can to match this new lens. Please see [Lens Correction](#) and the specific [Device Settings for Galvo](#) to get more in-depth explanations of the calibration settings.



**Warning**

While your initial testing may have been done in the center of your engraving field, it's suggested that you perform one or more tests at the edge of your field to fine-tune the Scale/Trapezoid/Bulge/Stretch to ensure accuracy and consistency.

In the event you find the design severely distorted at the edges but not at the center, it's likely your **Field Size** was set incorrectly. You'll need to follow the steps from the beginning to try and mitigate this.

**Scale**

In order to test scale, it's suggested you attempt to frame a square of known size in LightBurn (say, 60mm), and measure the corner-to-corner with calipers to adjust your X and Y scale as needed.

**Bulge**

Following that, you'll want to measure your design bulge; frame a square nearly as large as your field allows (errors are amplified at the edges of a galvo). Put the edge of a flat surface directly between the two corners of a side and check to see if the line bulges into or past the straight edge, and

adjust your bulge settings accordingly. Repeat this step for both axes.

**Trapezoidal**

Frame a square nearly as large as your field allows (errors are amplified at the edges of a galvo). Measure the length of the top edge and compare it to the length of the bottom edge, and adjust the trapezoidal value until they match

**Skew**

The fine-tuning of your skew can be done either by lining a set square along two edges to see if they are 90 degrees, or by framing a rectangle nearly as large as your field allows (errors are amplified at the edges of the field). Measure the distance between opposing corners, and compare it to the measurement of the other opposing corners (so that if you were to trace the lines you measured you'd end up with an X shape across your framed square). Your goal would then be to adjust the trapezoidal value until both measurements are the same.

**Repeat**

You may wish to repeat these checks to ensure they are still correct, following the changes made.

## Galvo LightBurn 1.2

## 5.13 3D Sliced Engravings

**Attention**

This section is new, and is a work in progress. Be sure to let us know [on the forums](#) or via [support](#) if we need to change something. Thank you!

Galvo users without a live Z-axis have the ability to make "2.5D" engravings with LightBurn and their galvo, producing objects with tactile and visual depth. LightBurn calls this mode "3D Sliced" due to the similarity to 3D printing slicers; where horizontal slices are deposited by 3D printers, LightBurn allows subtractive layer-by-layer operations.

3D Sliced mode uses greyscale images called powermaps to create depth in the engraving. Darker shades of grey will be cut with more passes and become deeper, while lighter shades of grey will be cut with fewer passes, making them shallower. These can be created by hand, although tools like [STL2PNG](#) that generate raster images from STL files are often used to make more complex depth maps. The greyscale powermap can be imported to LightBurn like any other image. 3D Sliced mode uses the depth map to generate up to 256 steps of engravings, with impressive results.

## 5.13.1 How-To

First, produce a greyscale heightmap image in any tool you choose and import it to LightBurn.

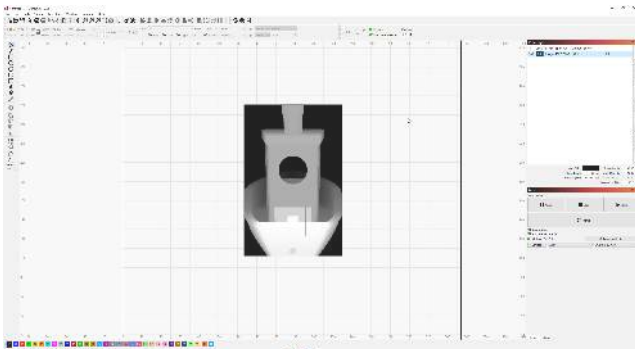

Open the [Cut Settings Editor](#) for the layer the image you've imported is on, and change its type to "3D Sliced".

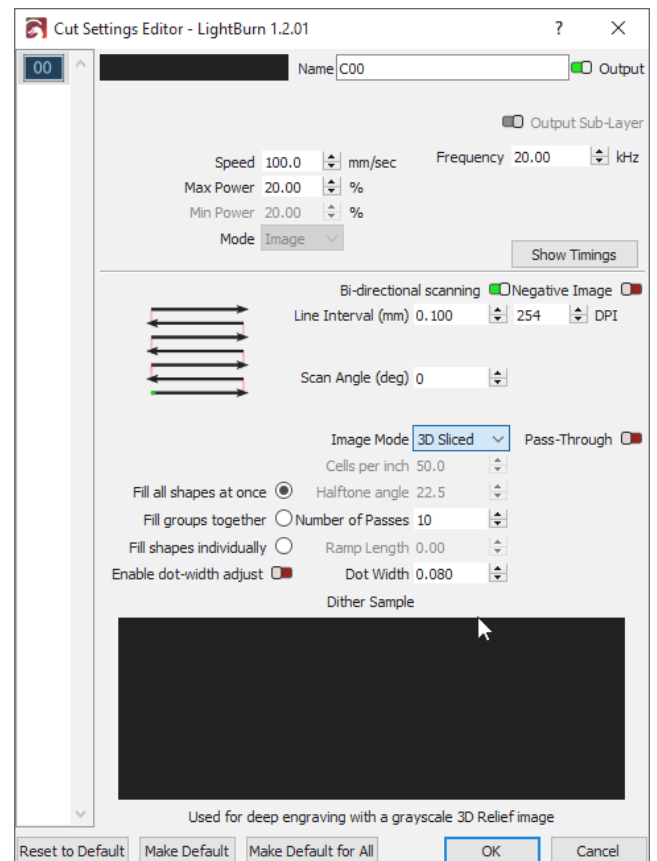

Next, change the number of passes entry to the quantity you intend to use for this operation. The more passes, the higher the effective resolution can be, though reducing the power such that it doesn't go deeper may be needed. Think of this as "layer height" for 3D printers.

### 5.13.2 Further Examples

**Note**

More complex, larger designs may take more time to process, because of the complexity of generating each pass. If you see this dialog, please be patient as your computer may need some time to prepare your design.

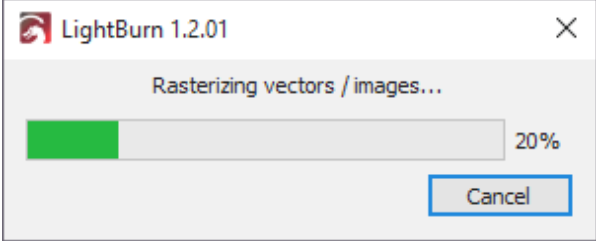

Check the preview to confirm your design is behaving as you're expecting. If you use the play button, you should see your design render from the bottom to the top, with black indicating the engraved portion for each layer.

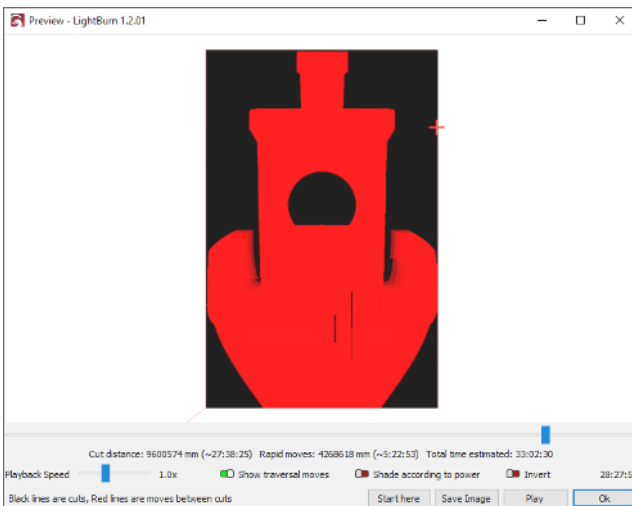
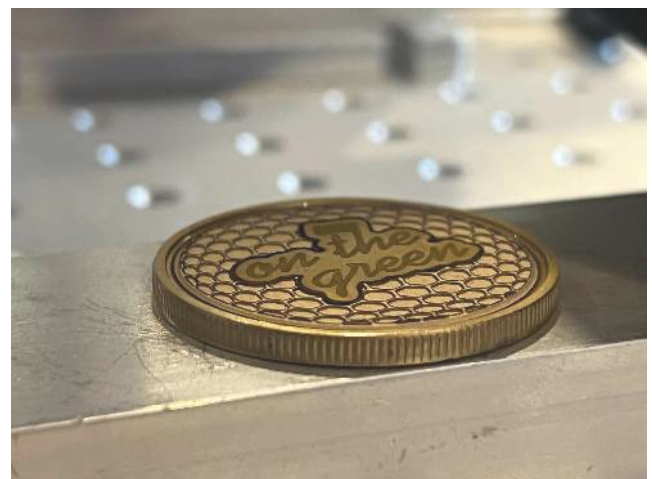
## 5.14 About Galvos

**Attention**

This section is new, and is a work in progress. Be sure to let us know [on the forums](#) or via [support](#) if we need to change something. Thank you!

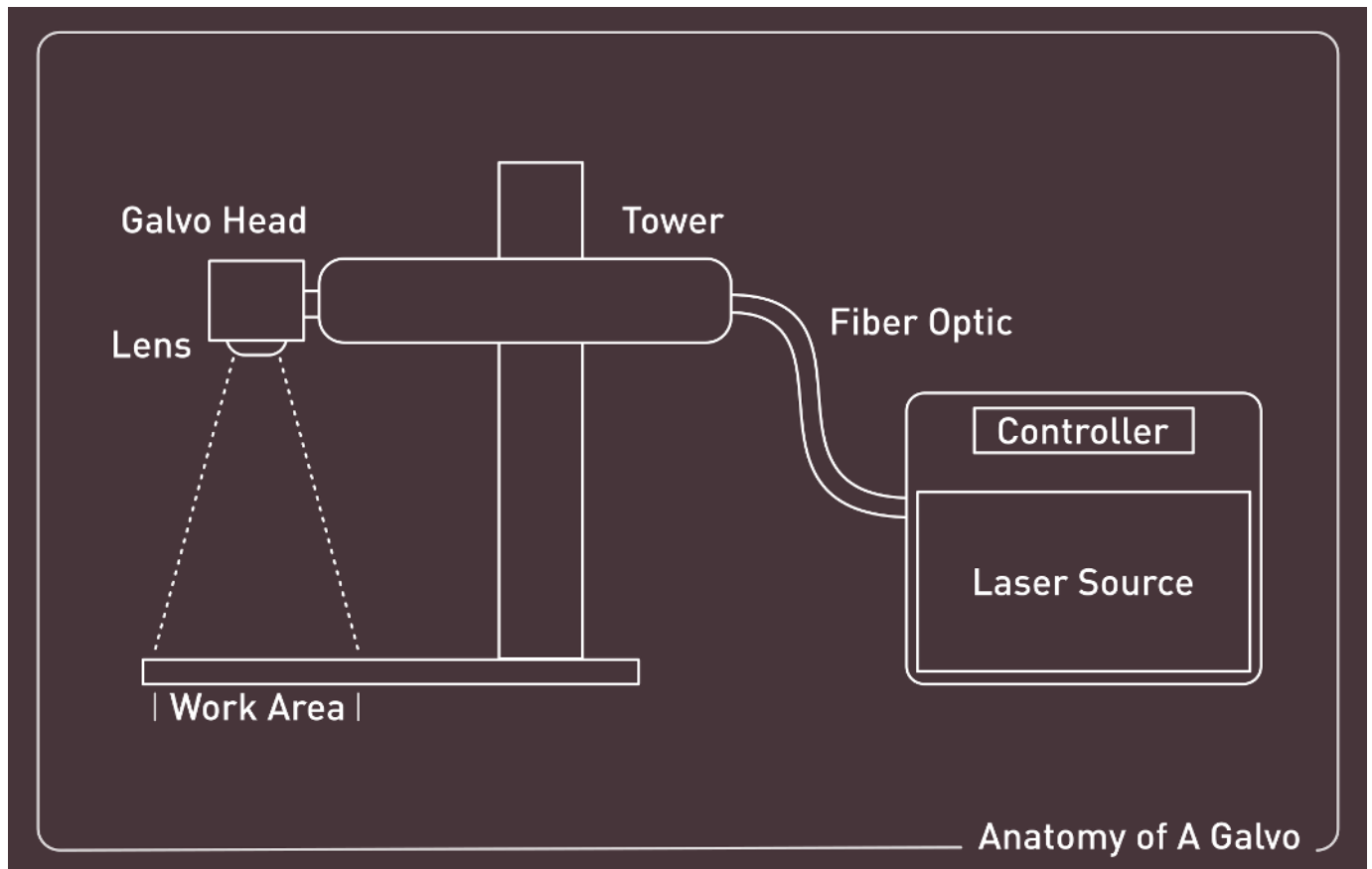

**Note**

### 5.14.1 Supported Types

The current types & manufacturers of galvo laser sources supported (as of LightBurn 1.2.00) are as follows:

- Raycus (RAYCUS)
- JPT (JPT)
- IPG (IPG\_YLP / IPG\_YLPM)
- MAX (MAX / JPT)
- CO<sub>2</sub>
- (as of 1.2.02) UV

### 5.14.2 Unsupported

These are devices that may work at some point in the future, have been communicated to our staff that users

would like to use them, but we can't 100% confirm behavior just yet.

- QUANTEL\_M20HF
- QUANTEL\_M20
- MANLIGHT\_PL
- VGEN\_YPFL
- EO
- QUANTEL\_M20EG
- QUANTEL\_M30EG
- IPG\_YLP\_E
- HFB
- Orion Laser

### 5.14.3 Sources

#### Fiber

Fiber lasers are incredibly common devices, due to their use for long-distance & high bandwidth networking; fiber lasers power the internet.

They make use of an optical pathway, made of silica glass to guide the light, resulting in a narrow, straight beam that's able to carry an incredible amount of energy and data. For galvo actuated fiber lasers, this means that the beam can move extremely quickly, making small adjustments via actuated mirrors, rather than complex gantry systems.

Due to the beam being formed inside of a solid mechanical apparatus, fiber lasers are considered "solid state" devices, whereas CO<sub>2</sub> laser tubes are generally considered "gas state".

#### STEP BY STEP

1. Light is created in a laser diode, a dedicated source that's "pumped" into the fiber optic cable, resulting in them occasionally being referred to as a "pump source".
2. Pump light is guided into the fiber optic cable. While the fiber optic is able to carry the beam, the cladding (or casing) on the fiber is the reason the beam stays *inside* of the fiber instead of dispersing out of it.
3. Light is amplified inside the laser cavity. As the light passes through this region, the particles rise to a higher energy level, getting caught and excited / relaxed into a singular wavelength of operation. A doped portion of fiber, mixed with certain rare earth elements, makes this possible, reflecting back and forth while doing so inside "Bragg gratings". *This is where it becomes a stimulated emission of radiation.*
4. Laser light of a particular wavelength is created. The specific element(s) used to dope the fiber effect what wavelength the beam becomes.

5. The beam is released and shaped. The light at this point is collimated (straight), and to produce a usable shape for engraving, marking, or more, lenses and/or beam expanders are used to adjust the collimation.

### 5.14.4 Q-Switched vs MOPA

These two terms are often used in conjunction, but what does that even *mean*? What's being switched? Why is it a MOPA?

Master Oscillator Power Amplifier (MOPA) lasers allow more timing adjustment than Q-Switched lasers. MOPA lasers allow for separate control of pulse duration and pulse frequency to produce highly accurate and controlled engravings or etchings. The general range of MOPAs can be as low as 2ns or as high as 500ns, allowing highly accurate adjustment of the energy dispersed into the material.

Q-Switched lasers are typically not adjustable in this manner, and operate at a fixed duration, typically between 80ns to 140ns.

### 5.14.5 Laser Timing Adjustment

Galvo lasers sometimes have granular, but adjustable tuning of when the beam is commanded on, or off, as well as how the mirrors are adjusted. Some of this calibration and adjustment is in **Lens Correction**, or provided by your laser manufacturer, but the fine tuning for corner approach and speed may need adjustment.

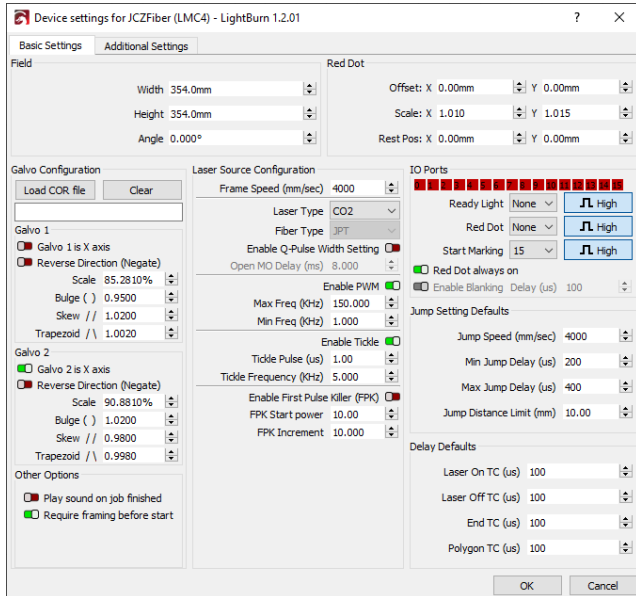

### Laser on TC ( $\mu\text{s}$ )

When attempting to mark, the physical mirrors of the galvo head must reach the desired speed before they begin marking. This fine tuning allows the user to reduce the burn-in potential during that initial acceleration by adjusting the source timing.

### Laser Off TC ( $\mu\text{s}$ )

Similarly to the above, when the mirrors of the galvo head must slow down as they attempt to end a marking move,

there may be a burn-in effect while slowing down. This setting allows the end timing to be adjusted finely.

### End TC ( $\mu\text{s}$ )

This setting adjusts how long the laser waits at the end of a series of vectors. Due to the fact the laser will physically lag behind the commanded state as decided by any software, this delay permits adjustment similarly to the **Laser Off TC**, except only for the end of polygons.

This setting applies to *any* marking move where the laser is turned off after execution.

### Polygon TC ( $\mu\text{s}$ )

This setting adjusts how long the laser "waits" at the end of each segment of a polygon, permitting the laser to settle appropriately, compensating for the same lag as outlined in **End TC**.

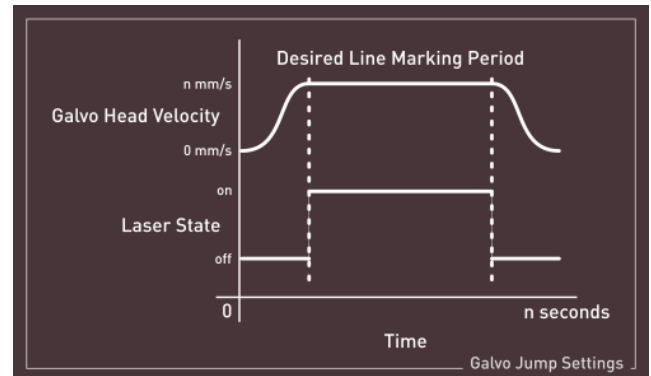

## 6. Tags

---

### 6.1 **Advanced**

---

- [Advanced LightBurn Bridge Setup](#)
- [Optimization Settings](#)
- [Using A Camera](#)
- [Moving LightBurn To Another Computer](#)
- [Running Multiple Independent Instances of LightBurn](#)
- [Galvo Anatomy](#)
- [Galvo Settings](#)
- [Cylinder Correction](#)
- [Lens Correction](#)
- [Rotary for Galvo](#)

### 6.2 **Beginner Docs**

---

- [Adding and Configuring a Laser](#)
- [How To use LightBurn](#)
- [Installation & Setup](#)
- [Laser Types](#)
- [Your First Project](#)
- [What Is LightBurn?](#)

### 6.3 **Calibration**

---

- [New Lens Setup](#)
- [Focusing](#)

### 6.4 **DSP**

---

- [Rotary Setup](#)
- [Using A Camera](#)

### 6.5 **Editing**

---

- [Two-Point Rotate](#)

### 6.6 **First Steps**

---

- [Adding and Configuring a Laser](#)
- [How To use LightBurn](#)
- [Find My Laser](#)
- [Laser Types](#)
- [Your First Project](#)
- [What Is LightBurn?](#)

## 6.7 GRBL

---

- [Common GRBL/GCode Setups](#)
- [Rotary Setup \(GRBL\)](#)
- [Using A Camera](#)
- [Console Window](#)
- [Move Window](#)

## 6.8 Galvo

---

- [Using A Camera](#)
- [LightBurn & Galvos](#)
- [3D Sliced Engravings](#)
- [Galvo Anatomy](#)
- [New Lens Setup](#)
- [Galvo Settings](#)
- [Cylinder Correction](#)
- [EZCAD Hatch & LightBurn Fill](#)
- [Focusing](#)
- [Framing Mode](#)
- [Galvo Installation](#)
- [Lens Correction](#)
- [Rotary for Galvo](#)
- [Galvo Setup](#)

## 6.9 Gantry

---

- [Rotary Setup](#)
- [Rotary Setup \(GRBL\)](#)

## 6.10 Guides

---

- [Laser Guides](#)
- [Running Multiple Independent Instances of LightBurn](#)

## 6.11 Libraries

---

- [Art Library](#)
- [Material Library](#)

## 6.12 LightBurn 1.2

---

- [LightBurn & Galvos](#)
- [3D Sliced Engravings](#)
- [Galvo Anatomy](#)
- [New Lens Setup](#)
- [Galvo Settings](#)
- [Cylinder Correction](#)
- [Focusing](#)



- [Galvo Installation](#)
- [Lens Correction](#)
- [Rotary for Galvo](#)
- [Galvo Setup](#)

## 6.13 **LightBurn Bridge**

---

- [Advanced LightBurn Bridge Setup](#)
- [LightBurn Bridge](#)

## 6.14 **Machine Guides**

---

- [Ethernet Connection \(Ruida\)](#)
- [Sculpfun S9 Flashing Guide](#)
- [Ethernet Connection \(Trocen\)](#)

## 6.15 **Primary Docs**

---

- [Common GRBL/GCode Setups](#)
- [Configuring A Ruida](#)
- [Find My Laser](#)
- [License Management](#)
- [Advanced LightBurn Bridge Setup](#)
- [LightBurn Bridge](#)
- [Optimization Settings](#)
- [Optimization Settings](#)
- [Trial or License Activation](#)
- [Overview](#)
- [Image Adjustment](#)
- [Center Finder](#)
- [Cut Shapes Tool](#)
- [Docking Tool](#)
- [Material Test](#)
- [Ruler Tool](#)
- [Modifier Tools](#)
- [Two-Point Rotate](#)
- [Variable Text in LightBurn](#)
- [Arrangement Toolbar](#)
- [Art Library](#)
- [Console Window](#)
- [Creation Tools](#)
- [Cuts and Layers](#)
- [Device Settings](#)
- [File List](#)
- [Text & Fonts](#)
- [Laser Control](#)
- [Machine Settings](#)
- [Material Library](#)
- [Move Window](#)
- [Numeric Edits](#)

- [LightBurn Settings](#)
- [Shape Properties](#)

## 6.16 Rotary

---

- [Rotary Setup](#)
- [Rotary Setup \(GRBL\)](#)
- [Rotary for Galvo](#)

## 6.17 Ruida

---

- [Configuring A Ruida](#)
- [Ethernet Connection \(Ruida\)](#)
- [File List](#)
- [Move Window](#)

## 6.18 Sculpfun S9

---

- [Sculpfun S9 Flashing Guide](#)

## 6.19 Settings

---

- [Device Settings](#)
- [Machine Settings](#)
- [LightBurn Settings](#)

## 6.20 Text & Fonts

---

- [Variable Text in LightBurn](#)
- [Text & Fonts](#)

## 6.21 Thunder Laser

---

- [Ethernet Connection \(Ruida\)](#)

## 6.22 Tools

---

- [Using A Camera](#)
- [Overview](#)
- [Image Adjustment](#)
- [Center Finder](#)
- [Cut Shapes Tool](#)
- [Docking Tool](#)
- [Ruler Tool](#)
- [Modifier Tools](#)
- [Two-Point Rotate](#)
- [Variable Text in LightBurn](#)
- [Creation Tools](#)

## 6.23 Trocen

---

- [Ethernet Connection \(Trocen\)](#)

## 6.24 Troubleshooting

---

- [Connection Issues](#)
- [GRBL errors](#)
- [LightBurn Editor](#)
- [LightBurn errors](#)
- [Output issues](#)
- [Ruida errors](#)
- [Troubleshooting](#)

## 6.25 UI

---

- [Rotary Setup](#)
- [Rotary Setup \(GRBL\)](#)
- [Material Test](#)
- [Modifier Tools](#)
- [Two-Point Rotate](#)
- [Arrangement Toolbar](#)
- [Art Library](#)
- [Console Window](#)
- [Creation Tools](#)
- [Cuts and Layers](#)
- [Device Settings](#)
- [File List](#)
- [Text & Fonts](#)
- [Laser Control](#)
- [Machine Settings](#)
- [Material Library](#)
- [Move Window](#)
- [Numeric Edits](#)
- [LightBurn Settings](#)
- [Shape Properties](#)
- [EZCAD Hatch & LightBurn Fill](#)
- [Framing Mode](#)

## 6.26 Windows

---

- [Running Multiple Independent Instances of LightBurn](#)